

Catalogue S



THE

METALLIC ROOFING CO.

OF CANADA LIMITED

Manufacturers of

Architectural Sheet Metal
Building Materials



TORONTO, CANADA.

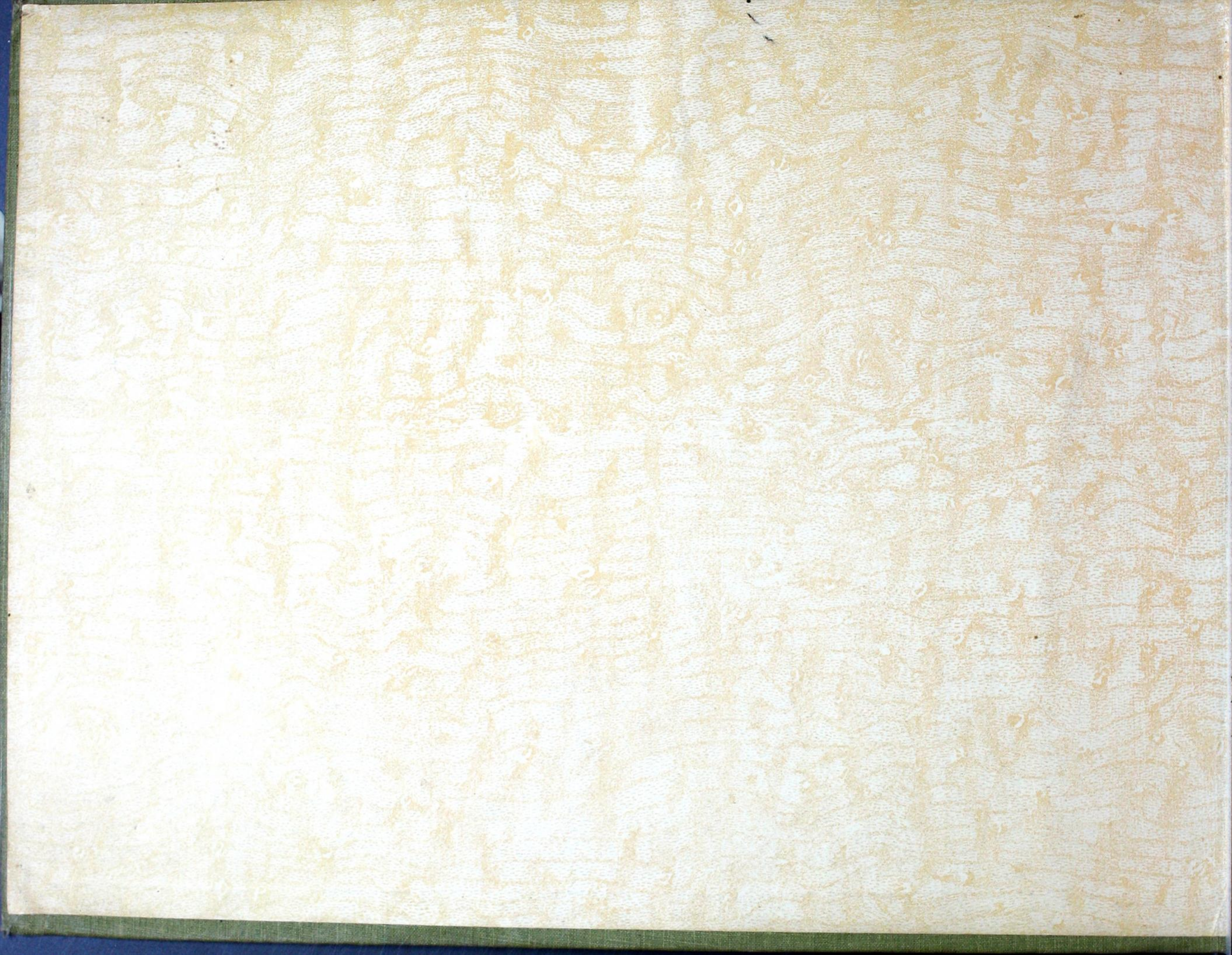

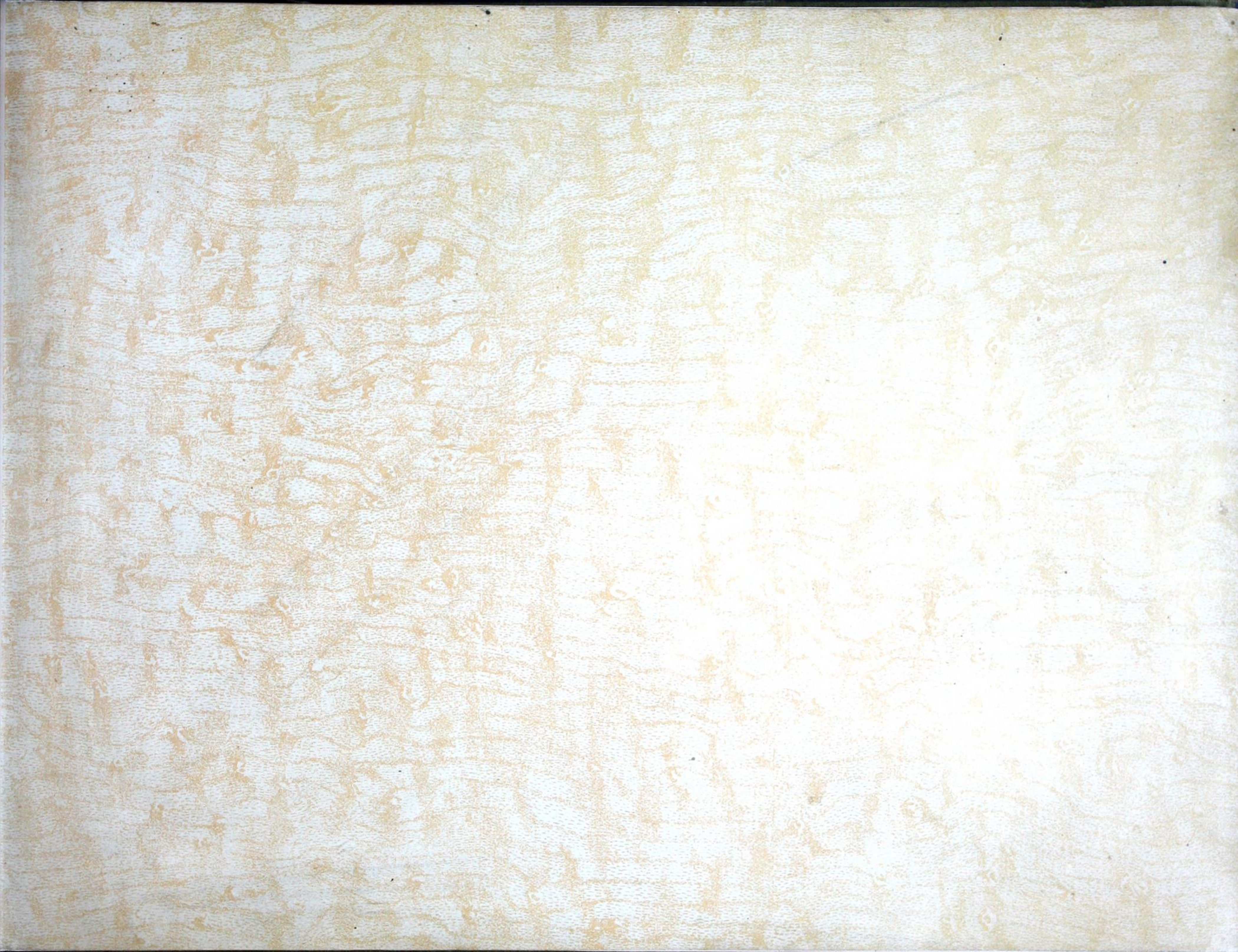

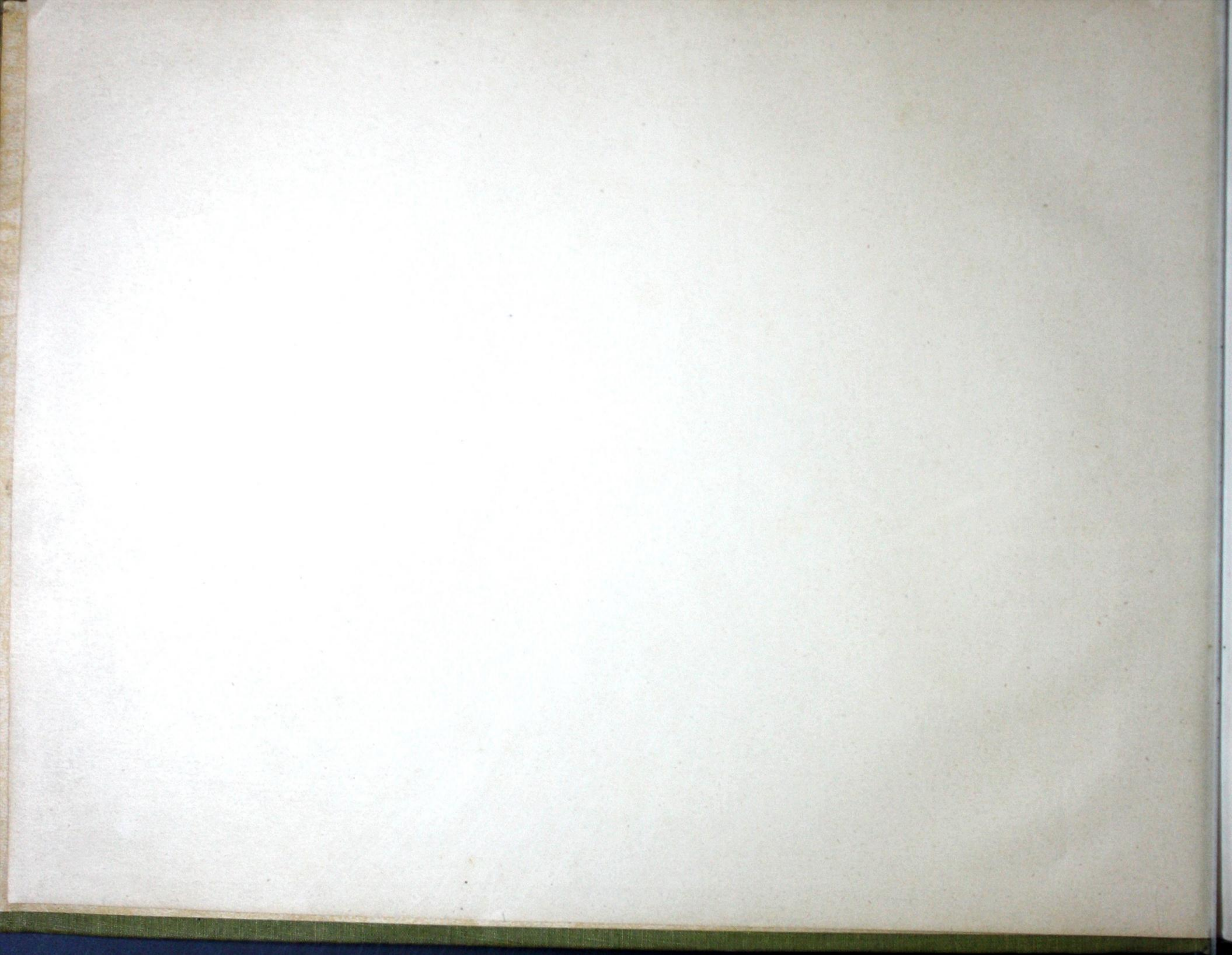

H. McLAREN & CO.
SELLING AGENTS
706 CRAIG STREET
MONTREAL, QUE.



Catalogue "S"

THE
METALLIC ROOFING CO
OF CANADA (LIMITED)

(INCORPORATED UNDER DOMINION CHARTER 1895)

MANUFACTURERS OF

Architectural Sheet Metal Building Material

OF EVERY DESCRIPTION.



HEAD OFFICE AND WORKS:

COR. KING AND DUFFERIN STREETS,

TORONTO, CANADA.

CABLE ADDRESS:
"METALLIC" TORONTO.

CODES:
A.B.C. (4th EDITION) and LIEBER'S.

Entered according to Act of the Parliament of Canada, in the year 1900, by The Metallic Roofing Company of Canada, Limited, in the Department of Agriculture.

H. MCLAUREN & CO.
706 SELLING AGENTS
CRAIG STREET
MONTREAL, QUEBEC



PRESS OF
MILN-BINGHAM PTG. CO.
TORONTO.

THE METALLIC ROOFING COMPANY OF CANADA, LIMITED, TORONTO, CANADA.

...INDEX...

A	
	PAGE.
Advantages over Wood Shingles.....	13
" " Slate.....	13
Angle Beads.....	113
"Aquaprobe" Oiled Building Paper.....	19
Architectural Ornamental Work.....	333-351
Arches, Corrugated Iron.....	67, 75
Awnings.....	76, 77

B	
Balls.....	341
Balusters.....	341
Bay Windows.....	309
Beaded Sheets.....	157
Beam and Girder Coverings.....	181-183
Board of Trade Building, Toronto.....	128
Borders and Friezes for Ceilings.....	167-172
Brackets, Zinc or Copper.....	347-348
Brick Siding.....	47, 48, 55
Bulletin Boards.....	314
Building Paper.....	19

C	
Caps, Window and Door.....	311, 312
Canadian Pacific Railway Elevators.....	62, 63, 65
Capitals.....	349-351
Ceilings, Embossed Steel.....	133-272
Centres.....	141, 150, 158-166
City Hall and Court House, Toronto.....	121
Clapboards.....	50, 54
"Climax" Ridge or Hip Caps.....	51
Continuous Rock-faced Stone.....	45
Conductor Pipes.....	277, 278
" Hooks and Fastenings..	279
" Heads.....	280
Confederation Life Building, Toronto.....	131
Corner Caps.....	54, 55
Cornices, for Ceiling Work.....	173-175

C	
	PAGE.
Cornices, Galvanized or Copper.....	289-304
Corrugated Iron.....	57-80
" Ceilings.....	157, 212
" Wood.....	74
Court House, Montreal.....	125
Crestings.....	53
Crosses.....	321
Croquets.....	335

D	
Diamond Tiles.....	30-32
Directions for applying Metallic Ceilings.....	135-139
Doors, Fire-Proof.....	81, 83-102
Door and Window Caps.....	311, 312
Dominion Bank, Toronto.....	130
Dormer Windows.....	305-308
Double Gutter Valley.....	56

E	
"Eastlake" Steel Shingles.....	20-25
Eavetroughs.....	273-276
Elbows and Shoes.....	279
Elevator Siding.....	49, 60, 61
Elevators.....	62-64
Embossed Steel Ceilings.....	133-272
"Empire" Steel Shingles.....	26, 27
Enrichments.....	344-346
"Eureka" Diamond Tiles.....	30-32
" Gothic ".....	33, 34
" Spanish ".....	27-29

F	
Fencing, Corrugated Iron.....	71
Festoons.....	342, 343
Finials.....	316-320
Fire-Proof Qualities of Sheet Metal.....	12
" Doors and Shutters.....	81-102

F	
	PAGE.
Fire-Proof Lathing.....	105-132
" Windows.....	103, 104
Fleur-de-lis Ornaments.....	338
Four-in-one Rock-faced Siding.....	44
Freehold Loan Co. Building, Toronto.....	128
Freights.....	15
Friezes and Borders for Ceiling.....	167-172
" Zinc or Copper.....	345-346
Fronts, Sheet Metal.....	322-332

G	
Galvanizing.....	17
General Hospital, Montreal.....	127
Girder Coverings.....	181-183
Gothic Tiles.....	33, 34

H	
"Hayes" Patent Lathing.....	105-132
"Halitus" Ventilators.....	287, 288
Heads, Zinc or Copper.....	348
Hip Caps.....	51-54
Hiscox Building, London.....	272
Home Insurance Building, New York.....	99, 100

I	
"Imperial" Ridge or Corner Caps.....	54
Instructions for ordering Metal Ceilings.....	134
Interior Finish in Sheet Metal.....	133-272
Iron Frame Construction.....	71-73
Iron Furring Strips.....	117

L	
Lathing.....	105-132
Lead Washers.....	72
Leaves.....	334-335
Le Grande Seminaire, Montreal.....	125
Le Monument Nationale, ".....	126

M. B. 167290

THE METALLIC ROOFING COMPANY OF CANADA, LIMITED, TORONTO, CANADA.

INDEX (continued).

M	<small>PAGE.</small>
"Manitoba" Siding.....	49
Mansion House, Cape Town.....	271
Mansard Windows.....	305-308
Metal Fronts.....	322-332
Metallie Ceiling.....	133-272
" Cornices, Galvanized Iron, or Copper..	289-304
" Lathing.....	105-132
" Sills.....	313
" Siding.....	41-50, 55, 56
" Shingles.....	20-34
" Skylights.....	281-286
Modillions.....	347-348
Mouldings for Metal Ceilings.....	176-180
N	
Nailing Corrugated Iron.....	66
" Ceiling.....	136
Nails, Wire.....	20
O	
Oiled Building Paper.....	19
Ogilvy & Sons' Store, Montreal.....	126
Ordering Corrugated Iron.....	80
Oriel Windows.....	310
Ornaments, Zinc and Copper.....	338
Our Goods.....	9
"Our Special" Rock-faced Siding.....	41-43
P	
Packages.....	16
Paints and Preservatives.....	19
Painting.....	16
Paper.....	19
Parliament Buildings, Ottawa.....	98
Paris Exhibit.....	315
Partitions, Corrugated Iron.....	70
" Angle Iron and Metal Lathing.....	115
Pediments.....	296, 304
Pressed Double Cap Roofing.....	35, 36
" Zinc and Copper Work.....	333-351
Protection from Lightning.....	13

Q	<small>PAGE.</small>
Quantity of Corrugated Iron to cover a Square....	80
Quoin Stones.....	55
R	
Reasons Why.....	14
Ready Roll Cap Roofing.....	37, 38
Ridge Caps.....	51-54
"Richardson's" Pressed Metal Doors.....	83-102
Rock-faced Sidings.....	41-45
" Steel Brick.....	46
" Brick Corner Cap.....	55
" Corner Stone.....	55
" Pilasters.....	56
" Quoin Stones.....	55
Roll Top Ridge or Hip Cap.....	51
Roof, The.....	11
Roofing.....	21-40, 57-80
Rosettes.....	340

S	
St. Michael's Hospital, Toronto.....	124
Saving in Insurance.....	12
Scrolls.....	336, 337
Sheet Metal Fronts.....	322-332
Sheet Steel Pressed Brick.....	47, 48, 55
Shells.....	338
Shingles.....	21-34
Shoes and Elbows.....	279
Shutters, Fire-Proof.....	81, 82
Sills, Metallic.....	313
Siding.....	41-50, 57-80
Skylights, Metallic.....	281-286
Spanish Tiles.....	27-29
Spandrel Ornaments.....	336, 337
"Special" Valley.....	56
Square, A.....	11
Stone Sidings.....	41-45
Strength of Corrugated Iron.....	75
Supports and Sheeting.....	14

T	<small>PAGE.</small>
Temple Building, Toronto.....	88-96
Terms.....	8
Three V Crimped Roofing.....	39
Tiles.....	27-34
Tools.....	18
Toronto University.....	122, 123
Twist Tops.....	341
Tympanum Panels.....	339

U	
Union Station, Toronto.....	73, 129
Use of Sheet Metal.....	10

V	
Valleys.....	56
V Corner Cap.....	54
V Crimped Roofing.....	39, 40
Ventilators.....	287, 288
Ventilating Centres.....	164, 165
Volutes.....	335

W	
Walls, Metallic.....	146-151, 156, 170, 195-199
Washers, Lead.....	72
Weights.....	15
Windows, Fire-Proof.....	103, 104
" Dormer and Mansard.....	305-310
Window Caps.....	311, 312
Wire Nails.....	20
Wreaths.....	343
Wrought Iron Awning Supports.....	76, 77

Y	
Y. M. C. A. Building, London.....	97



Our
Factory

TERMS.



CUSTOMERS with whom we are unacquainted, or who are not favorably rated by the commercial agencies, will kindly bear in mind that it is absolutely imperative that we be furnished with references, and given time to investigate them; or that we ship the goods to our own order, and make sight draft with bill of lading attached. Orders to be shipped in this manner must be accompanied by a deposit equal to one-half the value of the goods.

When we lay out work or figure quantities, we take every precaution to send material as close as possible to what is required for each job, but under no circumstances whatever will we assume any further responsibility for damage or loss of any kind, beyond agreeing to send any material that might possibly have been short shipped, as soon as we can after being advised.

Claims for errors must be made on receipt of goods. Check off goods and compare with invoice, and plan (if any), immediately on arrival, and if any error notify us at once.

Goods shipped according to order cannot be returned without our consent.

Returned goods should always be accompanied with an invoice and bill of lading. Credit will not be allowed for any goods received in a damaged condition.

Unless otherwise specially mentioned, all quotations are for prompt acceptance only, for goods F.O.B. Toronto, but whether we quote F.O.B. Toronto, or freight allowed, our liability ceases when we hand the goods to the transportation company and obtain their receipt for same, in good order and condition.

No one is authorized to act as agent for this Company, or to bind it in any way, unless special written authority to that effect is granted from the head office.

All orders accepted, or contracts made by us, are subject to strikes, accidents or other delays beyond our control.

All goods are guaranteed to be exactly as represented.

..OUR GOODS..

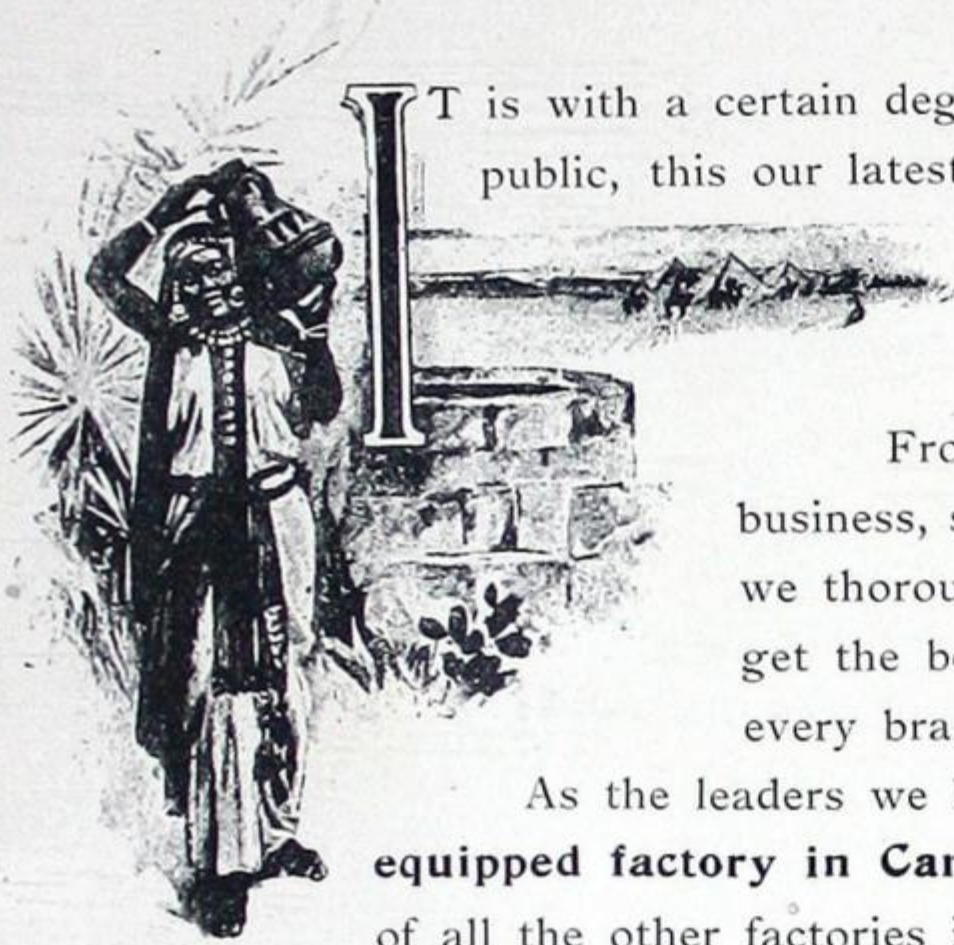

It is with a certain degree of pardonable pride, **as the pioneers in this line of business**, that we present to our friends, the public, this our latest catalogue, combining illustrations and descriptions of all the various products of our factory into one book.

At a time when sheet metal work was little used for building purposes, except in a very crude way, we foresaw its advantages and possibilities, and **in 1884 we started the first factory in Canada for the manufacture of this class of material.**

From the very small beginning of making only one design of metal shingles, the same people who started the business, still retain the management, and have grown up with it, step by step, to its present condition. In this way we thoroughly understand all the requirements, and every detail in connection with the business, so that our customers get the benefit, not only of our vast experience gained during the past sixteen years, but a personal supervision of every branch of the work.

As the leaders we have always kept leading, and at the present time **we have the largest, most approved, and best equipped factory in Canada, for the production of architectural sheet metal goods;** our output amounting to more than that of all the other factories in the Dominion combined.

We started out with the fixed determination to manufacture only such goods as we knew would give satisfaction, for we were, and are, alive to the fact that every order we fill is an advertisement either for or against us.

Our goods are now widely distributed from the Atlantic to the Pacific, and have won flattering testimonials from everyone who has used them. They are as they always have been—the **standard of quality, durability and construction**, and are the medium by which all others are judged, in proof of which it is only necessary to point out that all others who have come after us have attempted to copy **our original designs**, as nearly as they dared. Imitation is the sincerest kind of flattery, and shows conclusively that ours were considered the best, for people do not, as a rule, copy a poor article.

Irrespective of the competition of low-priced goods, **we have steadfastly maintained the same standard of excellence** for our goods, so that our customers are assured of getting the **best obtainable, and always just as represented.**

Carrying immense stocks as we do, combined with a large and experienced staff, we are enabled to give our customers **prompt shipment;** much quicker than can be obtained anywhere else.

We are always pleased to give our patrons the benefit of our experience by cheerfully and frankly furnishing them with any information they desire. All communications will be fully and promptly answered.

..THE USE OF SHEET METAL..



SHEET METAL for building purposes, though of comparatively recent origin in a practical sense, has passed its initial stages, and, as now sold in its present perfected form, possesses so many advantages over other materials as to make its use indispensable.

Twenty years of testing, often under most trying conditions, and in the face of much adverse criticism, has demonstrated its true worth. Old prejudices that existed against the use of anything, simply because it was not used hundreds of years ago, have been forced to the wall. In building construction, as indeed in anything else, we have to adapt ourselves to circumstances, and do as did the old masters—use the materials at hand. The massive stone and brick construction necessary in large buildings has been superseded by the lighter, smaller and stronger steel frame; the cumbersome, crumbling and expensive stone cornice by the lighter, fire-proof and cheaper metal one—the crude wooden shingle and heavy earthen tile by the more ornamental, durable, fire and lightning-resisting metal roofing—the wooden lath by its infinite superior in every respect, metal—the crumbling, dropping plaster and inflammable wooden ceiling by the more artistic, ornamental, and better, embossed steel—and now, in modern fire-proof buildings, even the wooden doors and trim have to give place to the metal. The latest example of the latter feature of metal is the completion by us in the “Temple” building, in this city, of our contract, whereby all the doors, jams, casings, window trim, dado and base are entirely covered with copper-plated steel, making a most effective, handsome and durable finish, and rendering the building unquestionably the most thoroughly fire-proof structure in Canada, if not in America. The “Temple” building is a huge modern ten-storey office building, containing nearly five hundred doors and over one thousand windows. About \$45,000 worth of our interior art metal work is used in this building alone, and Dr. Oronhyatekha, the S. C. R. of the Independent Order of Foresters (the owners), writes us that they are thoroughly satisfied with our work; that they will get a material reduction in their insurance by its use, and that he considers our doors and trim an absolute necessity in every fire-proof building.

We have attempted in this catalogue to set out some of the advantages and uses to which sheet metal may be put, but we could not possibly, in the space, cover nearly all the various uses to which it is adapted. This is governed altogether by the circumstances in connection with each particular case.

Practically anything that can be done in wood, stone or brick, can be duplicated in metal without losing any of the character or effect of the work. Its scope is almost unlimited; its advantages manifold.

We are prepared to furnish quotations promptly for any description of metal work, made to any detail or shape desired, and as we have had ample experience in all branches of the work we can guarantee to give satisfaction.

Write us fully just what is wanted, giving as much information as possible. All communications will be promptly and courteously answered.

The Roof.

AS a roof for your building is indispensable, let it be a good one. No part of the building is subject to the same amount of exposure, **and there is no part independent of its protection.** Do not slight the roof because plain material is the most convenient; there is really no economy in doing so. It is outside to be sure, but not easily hidden. Like the chimney, it is a necessity; as we cannot ignore it, we must try and make it as a part of the building, attractive. No money spent on a house will add more to its selling value than that expended in taste and material on the roof as the roof is the first thing that a person sees, and the first impressions are the hardest to overcome.

A poor roof is expensive at any price, even if it were given away, for the damage that might result from its use would generally be sufficient to purchase twenty good roofs.

A good roof must be: first, rain-proof; second, fire-proof; third, light in weight; fourth, durable; fifth, ornamental; sixth, not liable to get out of order. You can have such a roof by using our goods, at a cost within the reach of all, even for the cheapest kind of building.

A Square.

THE term "a square" means one hundred square feet. A space ten by ten feet constitutes a square. To find the number of squares in a roof, multiply the length of the roof by the length of the rafter over all, and divide by one hundred; the result will be the number of squares. On cottage shaped or hipped roofs, take the length half way up the rafter, and multiply the distance by the length of the rafter, which will give the area of the space. On irregular shapes, or roofs much cut up by valleys or hips, some allowance should always be made to cover the waste; usually about five per cent. is ample. For siding, take the total distance around the building, multiply it by the height, and if there are any gables, add their area and then deduct for any doors or windows. Where there are a great number of openings, or where the openings are small, the full amount should not be deducted.

For ceilings, add to the size each way the distance the cornice, (where such is used), will come down on the wall and multiply the total length so obtained by the total width; the result will be the number of squares. On irregular shaped ceilings, or ceilings cut up with openings or offsets, some allowance should be made for waste, over and above the actual space to be covered. Where ceiling plates are cut on the job we always figure that all pieces will be worked in.

EXAMPLES.

1—Take a roof 80 feet long, with rafters 30 feet each side, or 60 feet over all; $80' \times 60' = 4,800$ square feet = 48 squares.

2—To find the area of one side of a roof 33 feet along the eave and running up to a point at the top, the length of the rafter being 20 feet, take the width of the roof half way up the rafter, which would be $16\frac{1}{2}$ feet, multiply that by the length of the rafter (20 feet), and we get 330 square feet, or, allowing for the waste, say $3\frac{1}{2}$ squares of material to cover it.

3—To cover a ceiling 20×30 feet, using No. 303 cove with No. 922 foot moulding, (cove, 9 inches drop; moulding, 3 inches), $22' \times 32' = 704$ square feet = $7\frac{4}{100}$ squares.

A square of metallic shingles, tiles, siding plates, or ceiling, as sold by us, will cover 100 square feet when laid, less any waste in cutting or fitting. With "Pressed Double Cap," "Ready Roll Cap," and "V Crimped" roofings, it will also be found that our square as sold will cover 100 square feet, less any waste.

On account of the difference made in lapping **corrugated iron**, it is all sold by the 100 square feet, with **no allowance whatever for laps.**

Fire-Proof Qualities of Sheet Metal.

IT is a fact that has been clearly demonstrated beyond any doubt that wood, properly covered with sheet metal, is more fire-proof than solid iron, and will withstand more fire and greater heat without warping and twisting out of shape. The metal covering may be red hot all the time during a conflagration, and while the wood may be charred, it will not ignite. It affords protection where fire originates in adjoining or surrounding buildings; and in the event of a fire originating in a building so covered, the wooden timbers alone can be burnt, the metal proving an effectual barrier to its spreading beyond the building where it was started. Therefore, it is to the interest of everyone to use some style of metal covering.

The Fire Insurance Underwriters' specification for the construction of fire-proof doors and shutters in buildings, **calls for a wooden door covered with sheet metal**, as being the most effective barrier to the spreading of fire. When the insurance companies, who are usually the heaviest losers in case of fire, recognize the value of sheet metal as a fire protection **by insisting on its use in preference to solid iron doors**, it should prove conclusively the necessity for its use and set at rest any doubt as to its fire-proof qualities.

We have received numerous letters giving specific instances where buildings have been saved from destruction by being covered with our goods. We give below just one or two extracts—numerous others will be found in our book of testimonials. Mr. Samuel Nesbitt, general merchant, of Brighton, Ontario, writes: "A frame building adjoining my store, and **within eight or ten feet of the roof**, was burnt, and **had my building not been covered with your roofing I would have lost my store.**" Mr. P. McMurray, hardware merchant of Welland, Ontario, writes: "I covered a large barn in Welland with your metallic siding for the Queen's hotel. On January 25th the **hotel and all the surrounding buildings within six feet were burned down, while the barn, covered with your metallic siding, proved to be fire-proof, and was not damaged in the least, with the exception of being smoked by fire.**"

Saving in Insurance.

METAL covering is highly recommended by the Insurance Companies, as it furnishes no food for the flames, neither will it crack nor fall off by the action of heat or water, but will keep its place as long as there is anything left to sustain it. **Its application to a building reduces the rate of insurance fully one-third** as a rule, and in places poorly provided with fire apparatus, often considerably more. In many of the leading cities and towns in the United States and Canada, buildings covered with sheet metal are given the same rating as brick structures by the Insurance Companies doing business there, notably the cities of Cincinnati and St. Louis.

This **saving in insurance** alone will soon **repay the cost of metal covering** even for the cheapest kind of structure, as will be seen by a reference to our book of testimonials, containing the experience of people who state that they are actually saving sufficient for that purpose by the use of our goods.

Advantages over Wood Shingles.

GOOD wood shingles are a thing of the past. The machine-made shingles of to-day are a very poor substitute and not at all to be compared to the old shaved shingles. The present shingles are cut from very inferior timber, and the wood fibre is so furred or thrown up in sawing that it absorbs moisture readily and retains it tenaciously, soon rotting them out. The original cost of old-fashioned riven shingles made from good timber, without taking into account the cost of nails and expense of laying, is greater than that of our **Metal Roofing laid**. The best of wooden shingles will shrink, leaving crevices and increasing a hundred-fold the chances of leaks, besides only lasting a few years as they are at present being made.

Our Metal roofing can be applied at least three to four times as quickly as wood shingles, and **only costs about the same when laid on the building**, besides looking better and lasting very much longer.

Again, no wooden shingle roof is fire-proof, which is a very important item when it is considered that by far the greater proportion of fires originate on the roof; so that, all things considered, it will be found that **our metal roofing** is the **cheapest and best** in the end, not to mention the **saving effected in insurance** by its use.

Advantages over Slate.

IN the first place, the enormous weight of slate, about six hundred pounds per square, necessitates heavy and expensive roof timbers to support it, while metal roofing will not weigh one-sixth as much. Slate requires dressed, tongued, and grooved sheeting, while undressed cull lumber will do for metal, so long as it is reasonably sound. In winter, when there is much variation in the temperature, and the moisture between the slates freezes, they will crack and drop off. **Slate cannot resist heat in case of fire**, but will split and fall from the building, leaving the wood exposed to the element.

Again, it is not possible to drive nails tightly enough to bind the slates together, through fear of breaking them; thus they remain loose enough to allow snow or rain to blow up under them, especially in the case of driving storms such as frequently occur. So long as the rain falls vertically the water will flow from slate to slate and not leak, but if the storm is accompanied by wind, slate will frequently leak, especially if the roof has not a very steep pitch.

It is almost an impossibility to successfully repair a slate roof, without incurring a heavy expenditure.

Valleys in slate roofs are invariably made from similar material to that used in the construction of our roofing, and yet it not only stands a great deal more wear than any other part of the roof, but lasts just as long.

Protection from Lightning.

SCIENTISTS agree that a building covered with sheet metal has the best protection against lightning that can be given it, as the large surface of the metal scatters the electricity and renders it harmless.

Professor Mitchell says: "It is impossible that a building covered with iron should be injured by lightning."

Professor John Wise says: "My observation leads me to say that when metal roofs become the rule, injury to our buildings and their contents by lightning will have passed away."

Reasons Why some Sheet Metal Goods can be Sold at a Less Price than others.

IRON, steel, and all similar metals are rolled by the mills in different thicknesses, varying in weight from one-half to two and one-half pounds to the square foot, and in their raw state are invariably sold by the pound, so that it goes without saying that the heavier the metal the more it costs **by the foot**. There is also a vast difference in the **quality** of sheet metals, some grades costing in the flat sheet as much as a cent a pound more than others. Since this is the case with the raw material, **it must necessarily follow that goods made out of these metals are subject to the same difference**, and that the lighter or thinner grades can be sold for less money than the heavier ones, **by the square**; also that goods made from the poorer grades can be sold for less money than those made from the better grades. This is altogether outside of the construction of the goods, or the workmanship and finish put on them.

Persons who are not thoroughly conversant with these goods are apt to think that all metal shingles and siding are the same. This is a great mistake, for, as we have shown, there can be just as much difference in them as in anything else.

While metallic shingles and siding plates are made in different grades, **it does not at all follow that all manufacturers' grades are the same**, for different makers use different weights and qualities of plates.

If you want to make any comparison with metal building material, **compare the quality, the construction, the workmanship and finish**, and then **insist on knowing what the goods will weigh to the square, exclusive of any crating**, and see that you get them as represented.

Under each article illustrated in this catalogue **we have published just what our goods will weigh**, so that intending purchasers may see just what we are prepared to give. **Make every other manufacturer do the same thing**, then you will know what you are entitled to get.

If one maker sells goods guaranteed to weigh 80 pounds at \$3.20 per square, this is at the rate of 4c. per pound; if someone else offers goods claimed to be "just the same" at \$3.00 per square, his goods may only weigh 70 pounds, and this at the same rate (4c. a pound) would only make the price \$2.80 per square. Thus the goods claimed to be "just the same" are 20c. per square higher than the guaranteed goods at the same rate.

When a very low price is heard of for anything it is always safe to assume that, while it may not appear on the surface, there is some very good reason for it. The conditions of business in these days of keen competition, where one man's money is as good as another's, make this doubly true at the present time. The only safe rule is to deal with some reliable manufacturer who has an established reputation at stake.

Supports and Sheeting.

SOME forms of metal roofing, such as Corrugated Iron and V Crimped Roofing, may be laid directly on the rafters or on battens nailed across the top of the rafters without using any sheeting whatever, while for iron frame construction the metal may be fastened direct to the iron work. These different forms of construction are illustrated elsewhere in this catalogue.

Metallic shingles and siding plates require to be laid on close sheeting; undressed cull lumber will do, so long as it is reasonably seasoned and sound to hold the nails firm.

The distance between supports where metal is applied without using any sheeting depends on the kind and gauge of metal used. Metal may be applied safely for roofing purposes on supports placed as far as eight or nine feet apart, using eighteen gauge iron. On the roof of the large power house of the Toronto Electric Light Company, in this city, which we covered with our "Owl" brand of eighteen gauge galvanized corrugated iron, the iron purlins, to which the metal is applied, are eight feet one and a-half inches apart.

THE METALLIC ROOFING COMPANY OF CANADA, LIMITED, TORONTO, CANADA.

Where sheeting is used fewer and smaller roof supports are necessary for metal than for any other form of roofing, owing to the fact that metal is only about one-third the weight of wooden shingles, and about one-sixth that of slate; consequently, there is considerable saving of timber in the construction of the roof. For roofs having a large span nothing but metal should be used, so as not to cause any strain on the trusses or long timbers necessarily used in the construction of a roof of this kind.

Metal ceilings may be laid on sheeting or on furring strips. (See separate heading under metal ceilings.)

Weights.

THE weight of our **Metallic Shingles**, boxed ready for shipment, varies from about 85 to 120 pounds to the square, according to the kind. The shipping weight of the **Siding Plates** differs from about seventy to ninety pounds to the square, and of **Ceiling Plates**, not exceeding about eighty pounds to the square. The weights of the different goods are given under their respective headings in this catalogue or on our price lists.

Freights.

We give below the official railway classification of our different goods:

	LESS THAN CAR LOTS.	CAR LOTS.
Corrugated Iron, or Iron Roofing	3rd class,	5th class.
Iron Awning Frames	1st "	5th "
Iron Lath in bundles (owner's risk)	4th "	5th "
Iron Doors	3rd "	5th "
Metallic Ceiling or Sheeting, embossed	4th "	5th "
Metallic Ceiling or Sheeting, corrugated	3rd "	5th "
Metallic Shingles and Siding Plates	4th "	7th "
Metallic Cornices, crated or boxed	3 times 1st "	— "
Metallic Cornices, knocked down and crated or boxed	1st "	— "
Metallic Cornices in car loads, minimum 12,000 lbs. (owner's risk)	— "	3rd "
Metallic Cornice Ornaments	1st "	— "
Metallic Eavetroughs, nested closely, and wired in bundles, (owner's risk)	2nd "	5th "
Metallic Eavetroughs, nested, and crated or boxed	2nd "	— "
Metallic Conductor Pipe, in bundles, (owner's risk)	Double 1st "	5th "
Metallic Conductor Pipe, crated or boxed	1st "	5th "
Metallic Ventilators, Caps or Cowls	Double 1st "	4th "
Metallic Skylight Frames, glazed or unglazed	Double 1st "	— "
Skylight Glass, not over 1/4-inch thick, packed in boxes not over five feet long or wide (owner's risk),	1st "	4th "
Skylight Glass, over 1/4-inch thick, or boxes over five feet long or wide, (owner's risk)	1 1/2 "	4th "
Nails, in boxes or kegs	4th "	5th "
Paper, building or roofing	4th "	5th "

Packages.

OUR metallic shingles, siding and ceiling plates are all securely packed in substantial wooden crates or boxes, so that they cannot fail to reach their destination in good order and condition.

All packages are branded with our name and registered trade mark.

Painting.

ALL our painted goods for exterior use have a thorough coating on both sides of the celebrated "Sherwin-Williams" magnetic oxide of iron paint, ground in pure linseed oil, and specially prepared for us for metal work. It is of a rich dark reddish brown color, is absolutely pure, and contains nothing but the very best and **most expensive ingredients** obtainable for the protection of exposed metal work. All metal work should be repainted after being put on, and this may be done in any shade desired, **but only certain kinds of paint are suitable for metal for the foundation coat, so that it is absolutely imperative that the coating first put on next the metal, should be some preparation that will protect it. Ordinary lead paints may be put on over the oxide, but should never be used for a first coat on metal.**

For this reason, in order to ensure the proper protection to our exterior goods, we only paint them in the one shade, of reddish brown, for this is the only color we can get of this special preservative, which enables us to be sure that the coating will stand for any length of time. **Goods coated with lead or other light-colored paints are not suitable for outside use,** though they can be produced at considerable less cost than the coating used by us.

Our interior ceilings and side-walls are all well painted before shipping, receiving a good priming coat on both sides of **pure white zinc**, mixed with pure linseed oil and turpentine, which protects the metal, and forms a foundation that adheres to it as a permanent basis for further decoration. Lead paint or paint made from other light-colored pigments are no more suitable for inside than for outside metal work, as a foundation coat.

The quality and nature of the paint used by manufacturers of sheet metal goods, is a very important factor that should not be under-estimated or lightly considered by intending purchasers, for the reason that this coating should preserve the metal from corrosion, not only on the outside of the material itself, but also on the under side as well.

We use only the very purest and most expensive preservatives that our long experience in the metal business teaches us are the best; our sole aim, irrespective of expense to ourselves, being to have our painted goods coated with something that is tough and pliable, that will not scale or peel off, and that will be durable. This is what we are doing, and all we ask is, that this important matter be not lost sight of, but that a comparison be made of our preservatives with those of other manufacturers; when we feel sure that the result will fully bear out all our claims.

All painted roofing and siding should receive an extra coat of paint after being put on the building to cover any marks or scratches received in laying, and as there is no wear on the under side, a periodical coat of paint, once every four or five years, will preserve them indefinitely.

With the view of encouraging our patrons to repaint our goods just as soon as they are laid, **we send free of all charge with each shipment of painted roofing and siding sufficient preservative in thick paste form to recoat the work.** This paint should be mixed only with pure boiled linseed oil and turpentine, in the proportion of about three-quarters oil to one-quarter turpentine. For every gallon of oil and turpentine use about four pounds of the paste, thoroughly mixing the whole together, and with this mixture paint the surface to be covered.

Galvanizing.

THE galvanizing of metal is simply the covering of its surface with a coating of zinc, and this covering being a thorough preservative against corrosion of the metal when exposed to the elements, if properly done, the galvanized goods do not require any painting. The process consists of first removing every particle of scale or other foreign matter from the sheets and then immersing them in a bath of molten zinc, kept just below the burning point. When withdrawn they pass into a bath, first of hot water, then of cold water, where they become thoroughly washed. They then are rubbed dry with sawdust, afterwards being put in a dry-steam chamber, which completes the operation, except of brushing from their surface the particles of sawdust which adhere to them.

Our galvanized goods are all thoroughly and evenly coated on both sides with all the zinc that will adhere to them when taken from a bath of melted zinc.

Our galvanized Shingles and Siding Plates are not cut out of large sheets of galvanized iron, but we get our steel sheets made to the right size to suit our requirements, and then have them specially galvanized with the very best material, thereby ensuring a thoroughly good, even and pliable coating all over, and one that does not crack, flake nor peel off in bending or forming. When shingles or siding plates are cut out of large galvanized sheets there are always several raw edges, where the sheets have been cut that are of necessity not galvanized, and these raw edges, when exposed to the elements, are bound to corrode more or less; whereas **sheets as used by us, that are galvanized on all edges**, have a decided advantage over the ones cut out of large sheets.

In the manufacture of our large-sized sheets of Galvanized Roofing and Corrugated Iron we use only the finest quality of galvanized sheets, all well and evenly coated, free from scale, pin-hole, black spots or other defects.

Some people imagine that all galvanized iron is of the same quality, and for the information of persons not posted, we desire to say that **there is a difference in the price of over a cent a pound between different kinds of galvanized iron or steel**. Ask any hardware merchant, dealer or metal worker and he will tell you this is a fact.

If you are paying for galvanized goods, the above facts should be borne in mind, for if you do not get material that is **well galvanized**, with a coating that will really **preserve the metal**, then it is better to purchase painted goods and keep them well painted, for if the iron is poorly galvanized it will require to be kept painted anyway. To do away with the necessity of painting is the only reason for using galvanized material. Therefore the best is none too good, and if the material has to be painted the difference in the cost between black and galvanized iron or steel might just as well be saved.

Send for a sample showing quality of galvanized material used by us, and compare it with any other.

Remember the brand, our registered trade mark,



Tools Used in Applying Our Goods.



Fig. 1.
Snips, used with all our goods.



Fig. 2.
Hammer, used with all goods.



Fig. 3.
End Former, for turning end locks on "Pressed Double Cap" and "V Crimped" Roofing.

AFTER considerable experimenting we have at last succeeded in perfecting what has been long looked for by the roofing trade, viz.: a really effective combination squeezing and punching tool, as shown in Fig. 5, for use with "Pressed Double Cap" and "Ready Roll Cap" Roofings. By the use of this device (which we have fully covered by letters patent), a workman can readily accomplish more than double the amount of work that he possibly could by any other means, and with much less labor. This machine is so constructed that the operator squeezes together and punches a standing seam by the one operation, without changing the position of either himself or the tool, nor can the punching be possibly done until the seam is effectually squeezed together.

The action of opening the handles a certain distance, squeezes about eight inches of the seam at a time, which can be repeated as often as necessary to squeeze the distance between the rivets; then when it is desired to punch, the same operation, only opening the handles wider, cuts the piece out the proper size to suit the rivet. The punching device slides in a longitudinal bearing, bored through the head of the tool, and the opening of the handles the proper distance operates a toggle movement which works directly on the punch, bringing it in a straight line with the die, and exerting a powerful pressure with a direct motion, that will effectually cut the piece clean out through four thicknesses of twenty-six gauge steel, with very little power on the handles. The greatest pressure is given where it is most required, and at a point where the operator exerts the least power.

The mechanism is so simple and positive that a boy can operate it, and there is nothing to get out of order.

With each shipment of our "Pressed Double Cap" and "Ready Roll Cap" Roofing, when so ordered, we send **on loan** this tool. In sending this tool, however, we make it an **express condition**, that it will only be used for putting on our goods, and that it will be **returned promptly, charges prepaid. If not actually returned within thirty days from date of invoice**, (unless specially arranged for at time of sale), **a rent of \$1.00 per day will be charged for each and every additional day tool is retained; and we make this a strict condition in loaning the tool.**

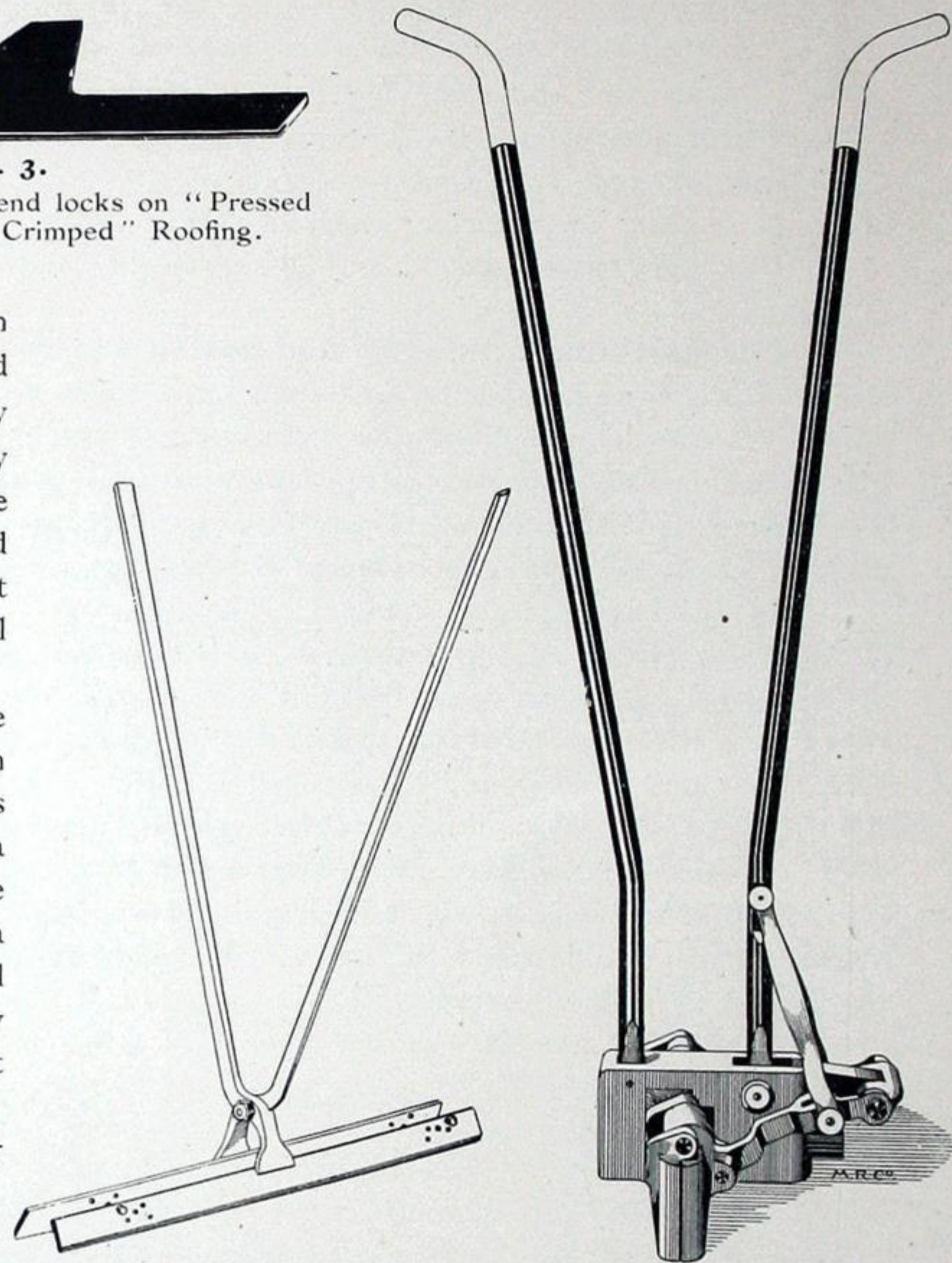

Fig. 4.
Edging Tongs used with "Ready Roll Cap" Roofing, will turn seam 1, 1 1/4 or 1 1/2 inches high.

Fig. 5.
Combination Squeezing and Punching Tool. Patented 1900.

Oiled Building Paper.

PUT up in rolls 32 inches wide by 50 yards long, containing 400 square feet. Average weight about 40 pounds per roll. Unquestionably the best building felt on the market for use under metal.

It is a good heavy paper, **thoroughly soaked in oil**, is **tough, odorless, water-proof, air-tight, clean to handle and will not shrink, curl up nor break.**

Paper should always be laid in courses, the width of the roll, across the building, overlapping the upper row over the bottom one about an inch, and nailing there securely.

We always advise laying a thickness of good building paper under all metal, particularly all dwellings or similar buildings. The additional cost is only trifling, and the building will be cooler in summer and warmer in winter. The paper acts as a non-conductor of both heat and cold, and is also a sound-deadener. It also absorbs

any moisture or condensation on the under side of the metal, caused in heated buildings by the hot air inside coming in contact with the cooler air outside.

Tarred felt should never be used under metal, as it is injurious to both metal and paint.

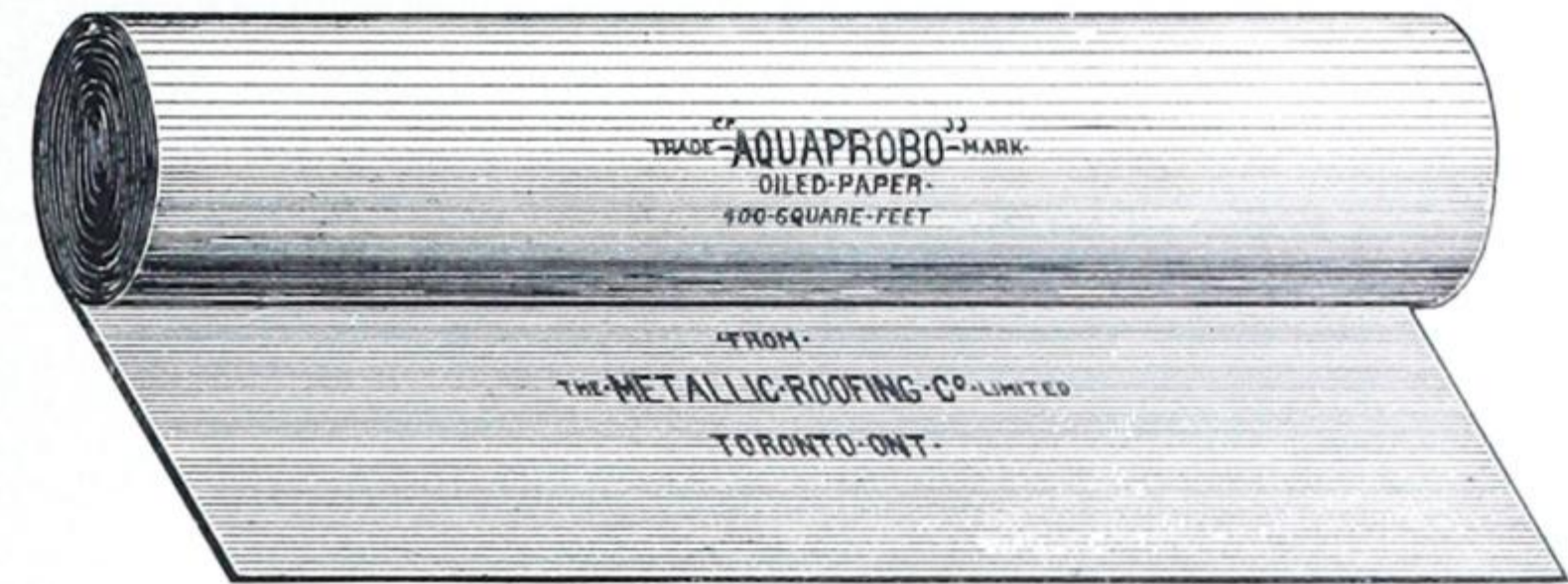

Fig. 6.

Paints and Preservatives for Metal.

WE can furnish, at the lowest prices consistent with good pure material, the same preparation that we use on our exterior goods. This celebrated Sherwin-Williams pure magnetic oxide of iron paint, mixed ready for use, can be supplied in any quantity desired, from one gallon up, or the same preparation can be furnished in a thick paste form, like putty, which only requires mixing with pure

linseed oil and turpentine, in the proportion of about three quarters of oil to one quarter of turpentine, to be ready to use. When re-painting metal work that has been standing some time, not less than about six pounds of paste paint should be mixed up with every gallon of oil and turpentine. One gallon of our mixed paint will cover from about seven to eight squares of metal work, so that it will be seen that it has a covering capacity much greater than ordinary paints.

This preservative is not low priced by any means, but it is **pure**, and the **best article obtainable for the purpose**, and as the labor of putting on this paint is no more than if cheaper material were used, it will be found to be the cheapest and best in the end. This is our sole object in using it ourselves, and in recommending its use, for we are not in the paint business, but simply sell this preservative for the benefit of our customers, to enable them to use the best material to protect metal work.

Wire Nails.

Fig. 7 shows the kinds of steel wire nails used in applying our different goods. The approximate number of these nails in a pound is as follows:

2-inch, 12 gauge	220 nails to a pound	1 1/4-in., 11 gauge, (Gal., large heads),	200 nails to a pound
1 3/4 " 10 " (large heads)	145 " " "	1 1/8 " 15 " (cone heads)	720 " " "
1 3/4 " 10 " (Gal'd, large heads),	125 " " "	1 " 12 " (large heads)	360 " " "
1 3/4 " 10 " (" oval heads),	115 " " "	1 " 12 "	410 " " "
1 1/2 " 15 "	650 " " "	1 " 16 "	990 " " "
1 1/4 " 11 " (large heads)	245 " " "		

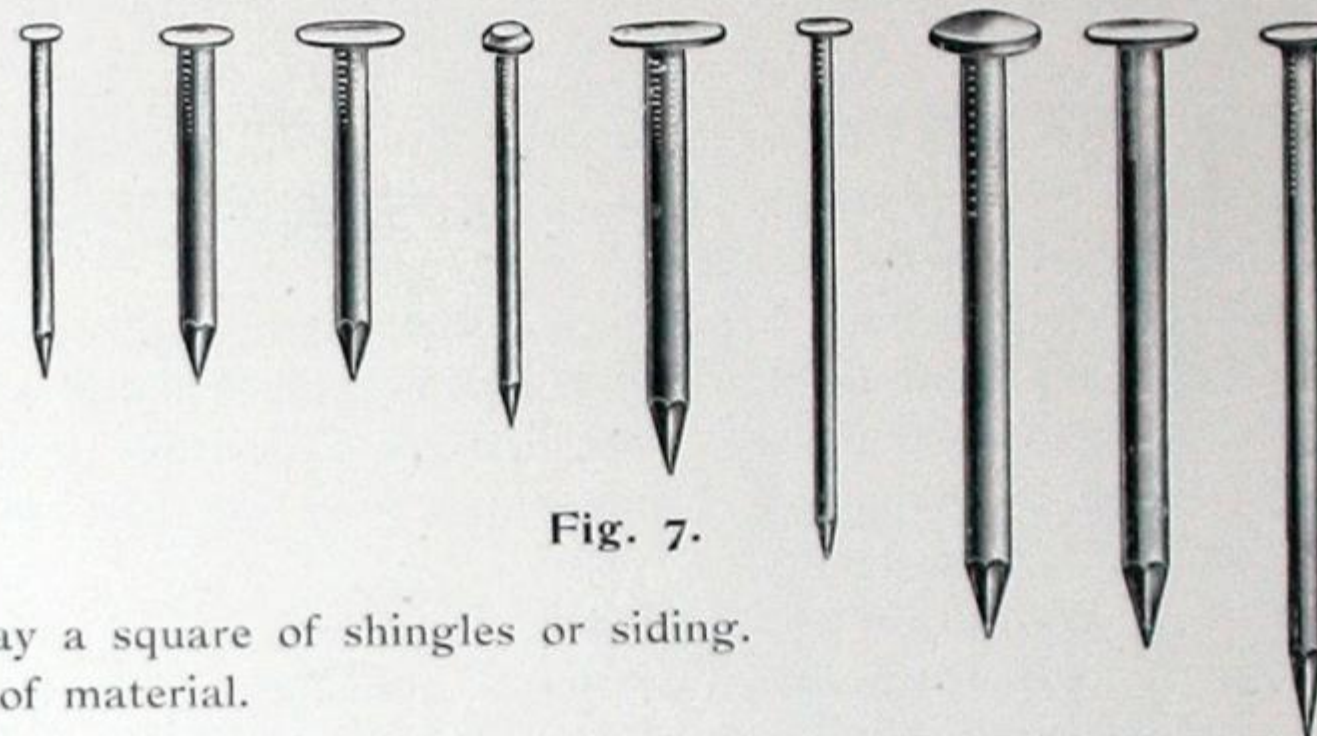

Fig. 7.

One pound of 1-inch, 12-gauge, or 1 1/4-inch, 11 gauge nails is more than sufficient to lay a square of shingles or siding. For interior ceilings and walls, one pound of suitable nails will lay at least one square of material.

"Eastlake" Steel Shingles.

Patented April, 1885.

March, 1887.

January, 1894.

July, 1894.

SUITABLE for all descriptions of roofs, down to one-quarter pitch, and have in many cases been successfully used on roofs of less fall than this. Universally conceded and acknowledged by experts to be the **best constructed, quickest and easiest laid metal shingle** that has yet been devised. Made by us for seven years before any other concern started in this business in Canada, and after fourteen years' experience and testing, during which time hundreds of thousands of squares have been made and sold in different parts of the country from the Atlantic to the Pacific, it stands to-day the standard by which all other metal shingles are judged; unequalled and unrivalled in any respect.

The pattern on the shingle, as shown in illustration, is pressed in the metal so as to appear only 7 1/16 x 4 3/4 inches, with a half-inch raise at the butt.

The design is after the "Queen Anne" style and stands out in bold relief, the lines being sharp and clear.



Awarded Silver Medal at Dominion and Provincial Exhibition, London, 1885. Awarded Bronze Medal at Ottawa Exhibition, 1887. Awarded Bronze Medal at Sherbrooke, Exhibition, 1891.



Awarded Gold Medal and Diploma of Honor at International Exhibition, Jamaica, West Indies, 1891. Awarded Bronze Medal at Western Fair, London, 1896.

“Eastlake” Steel Shingles.

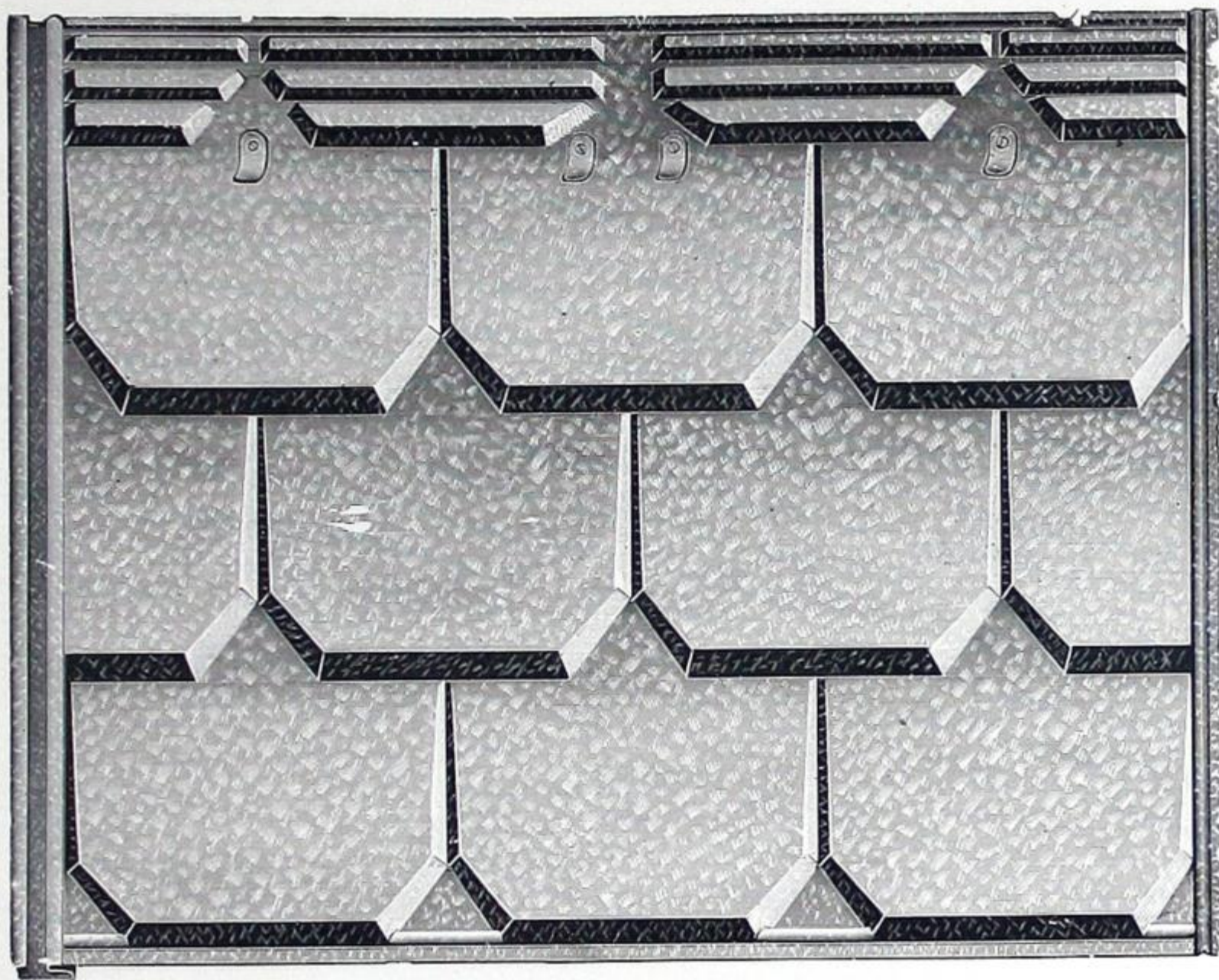

Fig. 8.

Above cut illustrates one single sheet of the **Galvanized “Eastlake” Steel Shingle**.
Covering size, 22 x 15 inches, 44 sheets to a square, covering 100 square feet.

Made in three grades of galvanized steel, the difference being in the thickness of the metal, otherwise the quality and finish are the same throughout.

No. 1,	weighing on the average,	105	pounds per square.
No. 2,	“ “ “	94	“ “
No. 3,	“ “ “	82	“ “

Weights given are the approximate average of the different grades, and are **exclusive of the packages**. Shipping weight about fifteen pounds to the square additional in each case.

Our galvanized “Eastlake” shingles are made from sheets of **steel cut the proper size first, and then galvanized**. Thus all the exposed edges of every shingle are properly protected with the galvanized coating, while shingles made from plates cut out of large sheets have sheared edges exposed to the elements, which, not being coated, must necessarily soon corrode. (See page 17, “galvanizing.”)

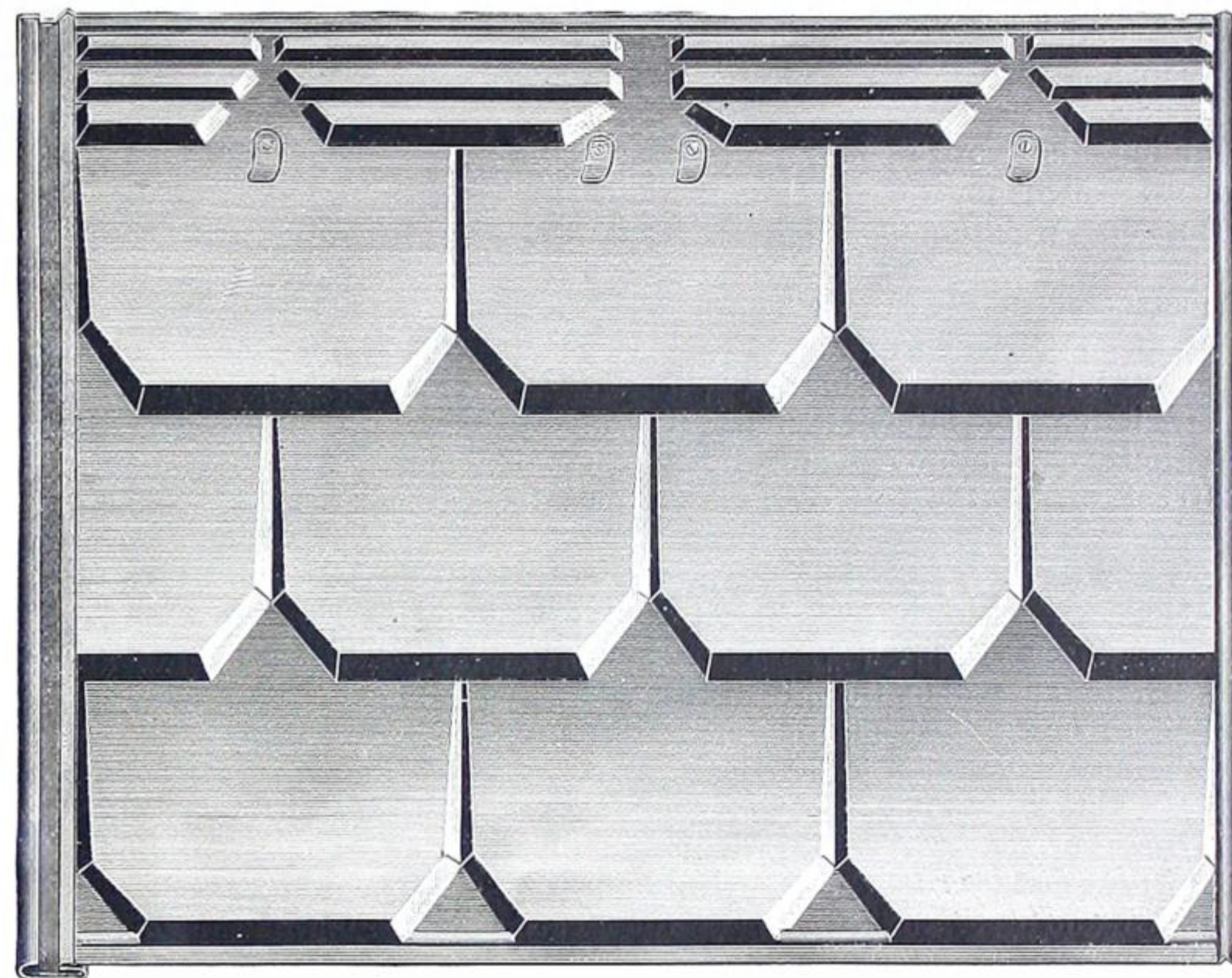

Fig. 9.

Illustration showing one single sheet of the **Painted “Eastlake” Steel Shingle**.
Covering size, 22 x 15 inches, 44 sheets to a square, covering 100 square feet.

Made in three different weights of painted steel; quality of material, workmanship and finish the same on all grades.

No. 1,	weighing on the average,	93	pounds per square.
No. 2,	“ “ “	83	“ “
No. 3,	“ “ “	70	“ “

Weights given are **exclusive of the packages** and are the approximate average. Shipping weight about fifteen pounds per square additional in each case.

Painted shingles are all thoroughly coated on both sides with the most expensive, purest and best preservative known for metal work, viz.: the celebrated Sherwin-Williams magnetic oxide of iron paint, made specially for us. (See page 16, “painting.”)

THE METALLIC ROOFING COMPANY OF CANADA, LIMITED, TORONTO, CANADA.

Fig. 10 represents the method of uniting our "Eastlake" shingles at the sides, by means of our Patent Telescopic Side Lock, which fully allows for contraction and expansion of the metal, and is provided with a concealed gutter, running the entire depth of each sheet, which makes leakage at the joints an absolute impossibility. The side lock on these shingles is so constructed that it cannot be crushed

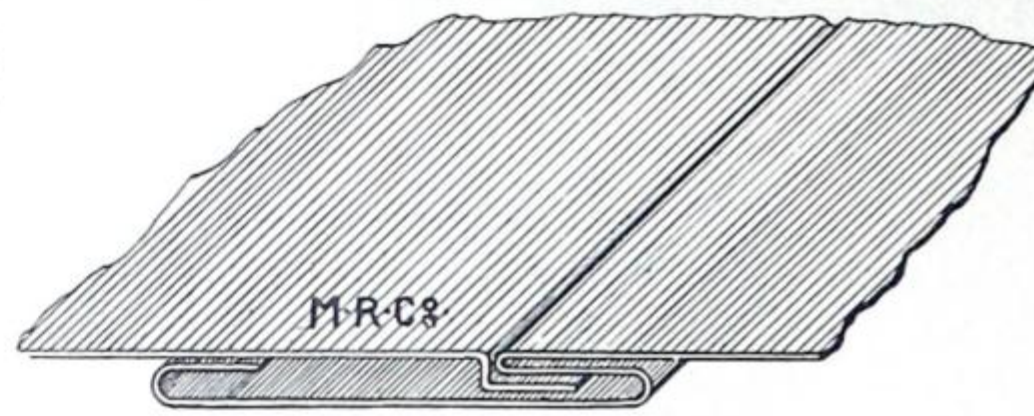

Fig. 10.

out of shape when applied to the roof, and has a complete and perfect gutter under each side lock, capable of carrying off any water, so that it is absolutely the tightest and safest Telescopic lock on the market, as, if any water does get into the lock, it is immediately carried off in the gutter, and empties itself on the next course below.

Please note carefully the construction of this combined side lock and gutter, as it is a very important feature, and the "Eastlake" is the only shingle possessing a side lock formed in this way.

When required, the eave shingles for the first course are supplied by us, as shown in the illustration, Fig. 11. Three eave shingles are equal to one full sized shingle. When a roof projects over the building all that is necessary is to nail through the bottom of the first course without using any eave shingles, which are sent only when ordered.

On the upper edge of each shingle, and three inches down from the top, are four cleats, securely fastened to the body of the plate before leaving our factory, as shown in the illustration. The shingles are nailed along the upper edge, above the cleats, to the roof boards with not less than four 1-inch 12-gauge wire nails to each sheet, and one course laps down over the other to the cleats on the course below, which are bent each shingle, down to the cleats, is provided with heavy corrugations, and this, combined with the holding of the bottom of each course down securely by our system of invisible cleats, effectually prevents any drifting or backing up under the shingles. These cleats are made from the very finest quality of extra coated, heavy tinned steel, which will not crack nor break in bending, and they are of great advantage in laying the shingles, as they enable the roofer to keep each course straight without the aid of a chalk line.

Advantages the "Eastlake" shingle possesses over any other metal shingle on the market:

1. Can be applied for at least 25 per cent. less than any other metal shingle. This has been demonstrated scores of times by actual record.
2. There are only 44 sheets to the 100 square feet.
3. They are laid from right to left, so that the workman is always facing his work.
4. There is no cleating down or malletting of seams, and only one lock to enter at a time, which is so large and open as to not need any tugging or pulling to make the shingles go together, but the operation of applying consists of simply slipping the edge of one sheet into the lock of the other. (See Fig. 10.)
5. Shingles are all accurately squared; therefore all exactly of the same size.
6. Cleats rivetted on perfectly parallel with bottom edge, enabling roofer to keep each course straight without the aid of a chalk line.
7. Perfect side-lock that is impossible to crush out of shape, and which fully provides for contraction and expansion.
8. The only metal shingle possessing a water gutter under each side joint, making leakage an absolute impossibility. (See Fig. 10.)
9. Ample provision made for ventilation on the under side, consequently an entire freedom from any condensation or moisture at that point.

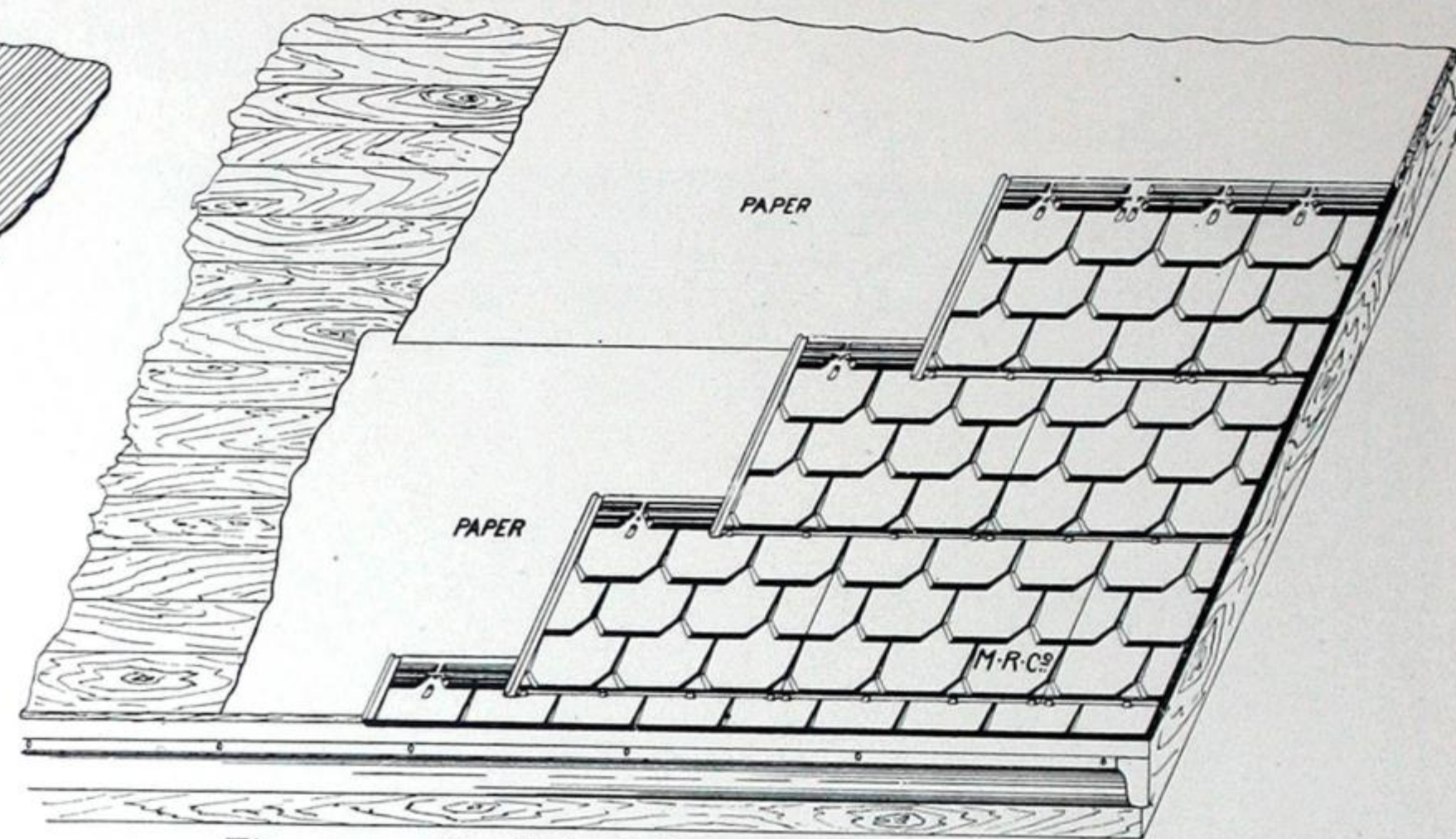

Fig. 11.—"Eastlake" Shingles as applied to a roof.

The genuine goods all bear our name and trade mark, thus:—

TRADE
"EASTLAKE"
MARK.

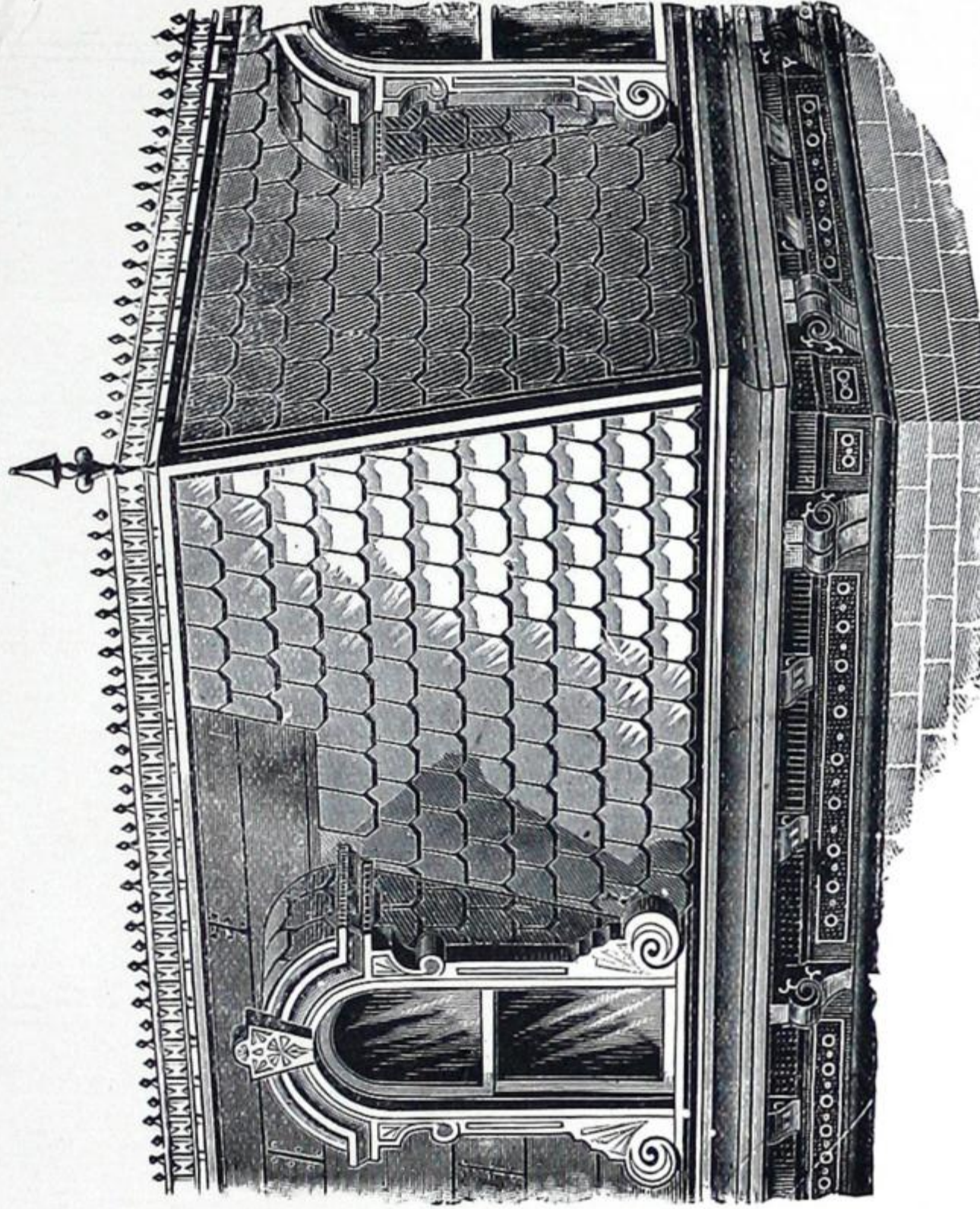

Fig. 12.— The appearance of our "Eastlake" Shingles on a Mansard Roof.

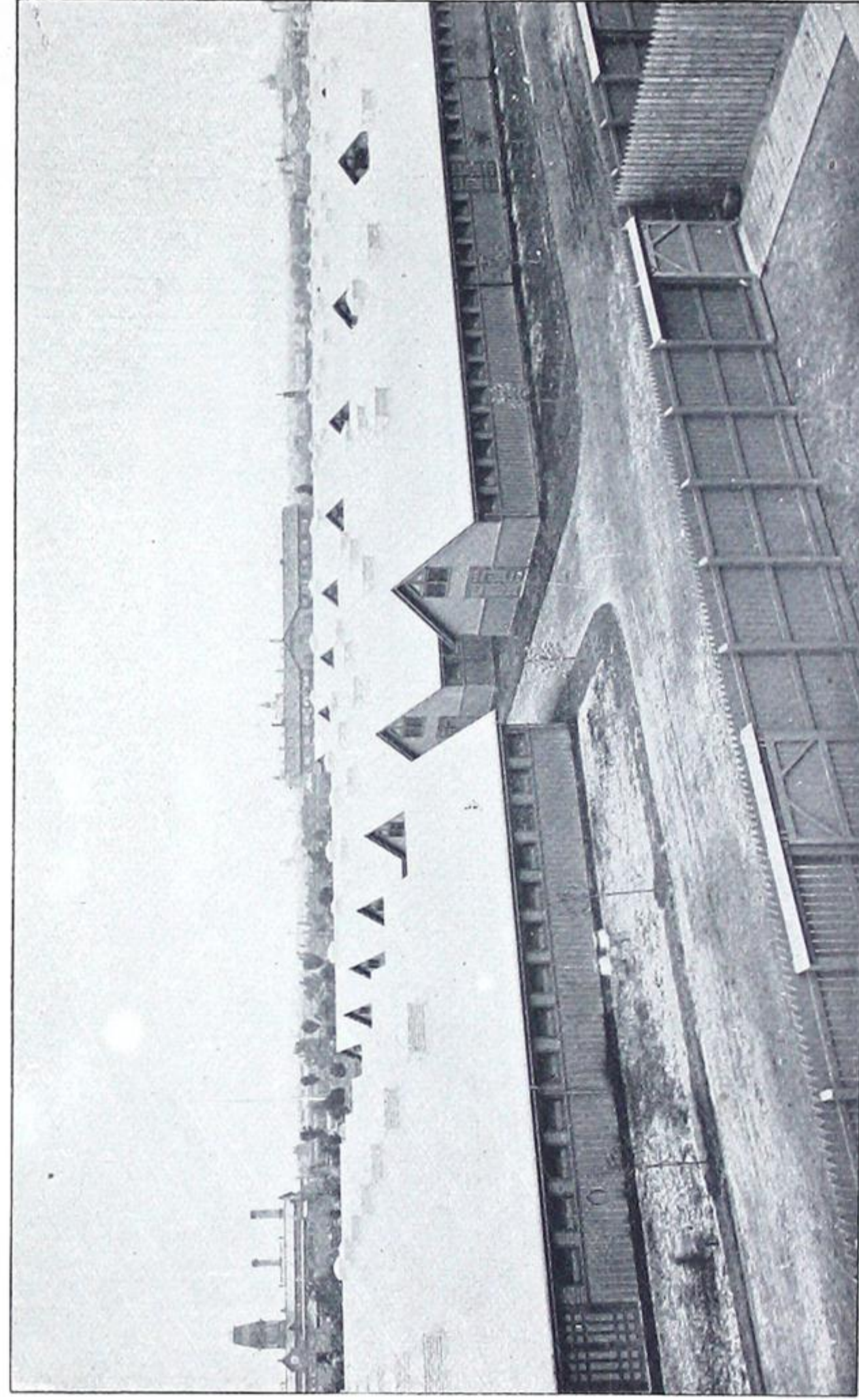

Fig. 13.— Birds'-eye View at the Toronto Exhibition Grounds.

Showing the roofs of some of the stables covered with our "Eastlake" galvanized Steel Shingles. In the distance is the Dog Building, on the right, the roof of which is also covered with our "Eastlake" Steel Shingles, while on the left is the Machinery Hall, covered with our galvanized Sheet Steel Pressed Brick.



Fig. 14.—Grand Stand, Exhibition Grounds, Toronto,

875 ft. long, with seating capacity for 12,000 persons. Covered with "Eastlake" Galvanized Steel Shingles. On these grounds alone, we have covered, with our Steel Shingles, the roofs of 52 Buildings, containing in all 326,532 square feet.

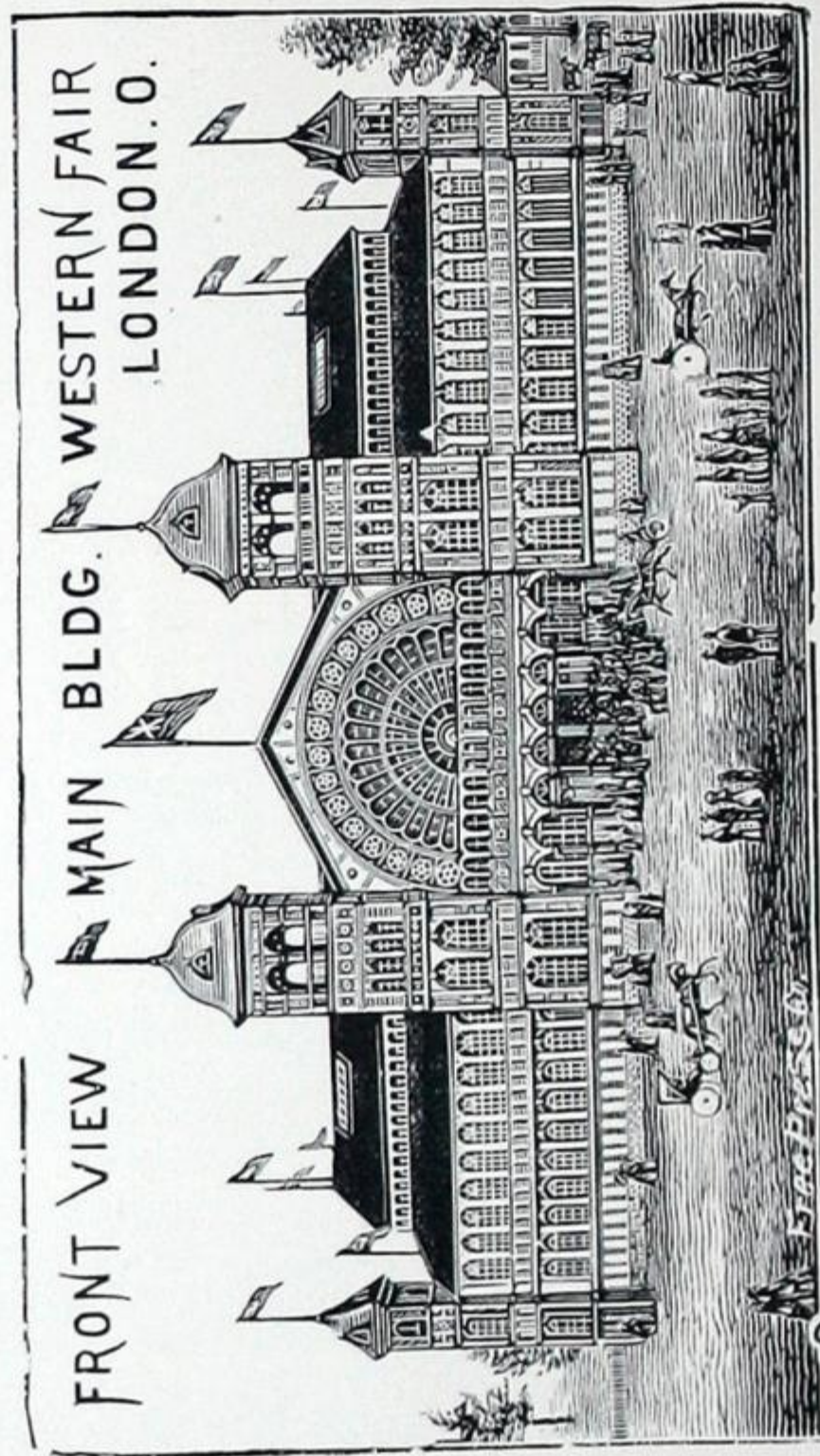

Fig. 15.—Roofed with "Eastlake" Steel Shingles.

THE METALLIC ROOFING COMPANY OF CANADA, LIMITED, TORONTO, CANADA.

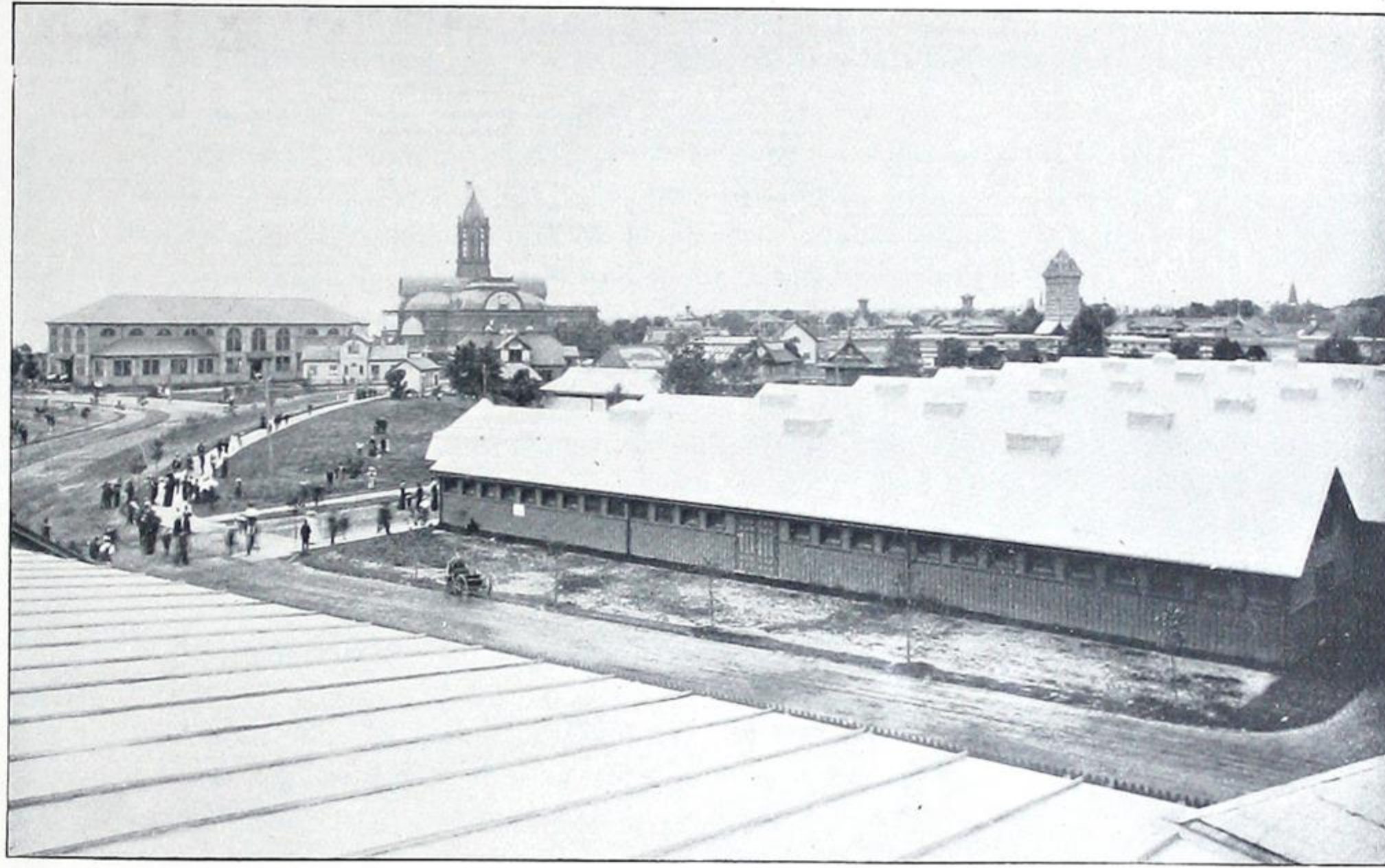

Fig. 16.

View taken from Top of Grand Stand on Toronto Exhibition Grounds.

Showing the roofs of some of the stables in the foreground, covered with "**Eastlake**" Galvanized Steel Shingles. In the distance is the **Annex Building**, on the left, also covered with our Steel Shingles, to the right of which is the **Main Building**.

“Empire” Steel Shingles.

Patented April, 1883, and November, 1885.

Suitable for all Descriptions of Roofs, down to One-quarter Pitch.



Fig. 17.

Covering size, $11\frac{1}{2} \times 8\frac{1}{4}$ inches; 152 sheets to a square.

a doubt, the perfection of roof covering, and will outlast any other material, with the exception of, perhaps, copper. **We will warrant the Galvanized “Empire” Shingles rust-proof, without the necessity of painting.**

Fig. 18 represents one single sheet of the **Painted “Empire” Steel Shingles.** One grade only. Made from **tinned** steel. Approximate average weight, about seventy-eight pounds per square; shipping weight, about ninety pounds per square.

The painted “Empire” Shingles are thoroughly coated on both sides with the most expensive preservative of magnetic oxide of iron paint, made specially for us. (See page 16, “Painting.”)

FIG. 17 shows one single sheet of the **Galvanized “Empire” Steel Shingles.** One grade only. Made from **tinned** steel plate. Approximate average weight, about ninety pounds per square; shipping weight, about one hundred pounds per square. **The “Empire” is the only shingle on the market that is galvanized after being formed into shape** (all others being made from plates galvanized first), consequently there is no possibility of there being any cracking of the galvanized coating in forming, and **no raw edges are exposed.** They are first made up from soft stamping **tinned** steel plate, with every lock and fold perfect before the operation of coating commences. The sheets being already **tinned**, every particle of scale or foreign matter is already removed from their surface, and they do not have to go into any acid bath, as would be the case if black iron or steel were used.

They are then immersed in a huge kettle containing about eighteen thousand pounds of melted zinc, and kept at a temperature just below the burning point. When withdrawn they are thoroughly washed, first in hot, then in cold water, and are rubbed dry with sawdust, then put into a dry-steam chamber, which completes the operation—except brushing from their surface the particles of sawdust which adhere to them. This process requires a great amount of skill and care, besides the necessary handling, but when done, the goods produced in this manner are, beyond



Fig. 18.

Covering size, $11\frac{1}{2} \times 8\frac{1}{4}$ inches; 152 sheets to a square.

THE METALLIC ROOFING COMPANY OF CANADA, LIMITED, TORONTO, CANADA.

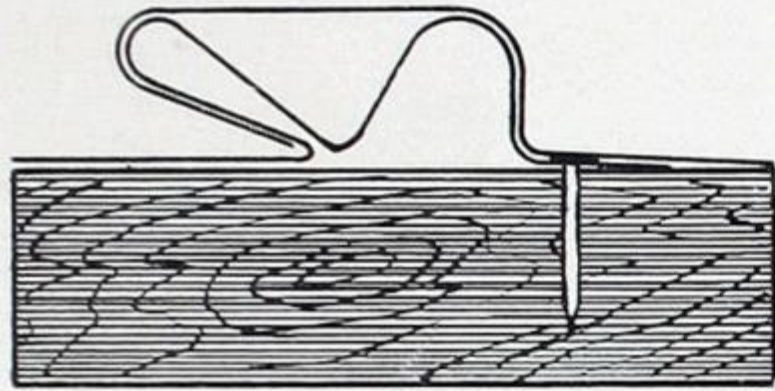

Fig. 19.—Side Lock (enlarged),
"Empire" Shingle.

is a very important feature, as it adds to the life of the roof very materially, preventing, as it does, any possibility of corrosion from the under side.

The corrugations forming the side lock and water gutter on one side, and the hook-over part on the other side, in addition to the ribs at the top, and the heavy design on the body of the plate, so stiffen these shingles that it is impossible to injure the locks or squeeze them out of shape, making the most rigid shingle that is produced.

Fig. 20 shows commencement of first two courses, starting every alternate course with a half sheet, so as to break joints.

The shingles are nailed to the sheeting with about two, one-inch twelve-gauge, wire nails through the flange

on the right-hand side of each sheet, and the next sheet hooks over the nails and water gutter into the lock, so that all nail heads are covered, as shown in Fig. 20. The upper edge of each shingle, down to where the overlap comes, is provided with heavy beads, and the shingle being so stiff, it lies very close and tight at the butt to the underlying course, effectually preventing any drifting or backing up under the shingles.

The genuine all bear our name and registered trade mark, thus:—

TRADE
"EMPIRE"
MARK.

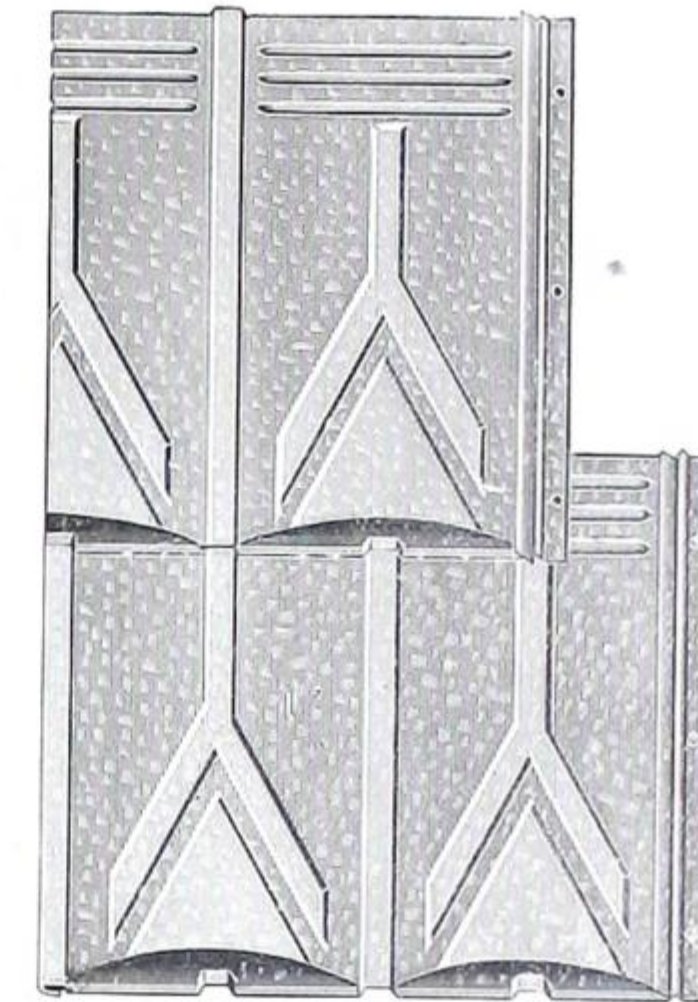

Fig. 20.

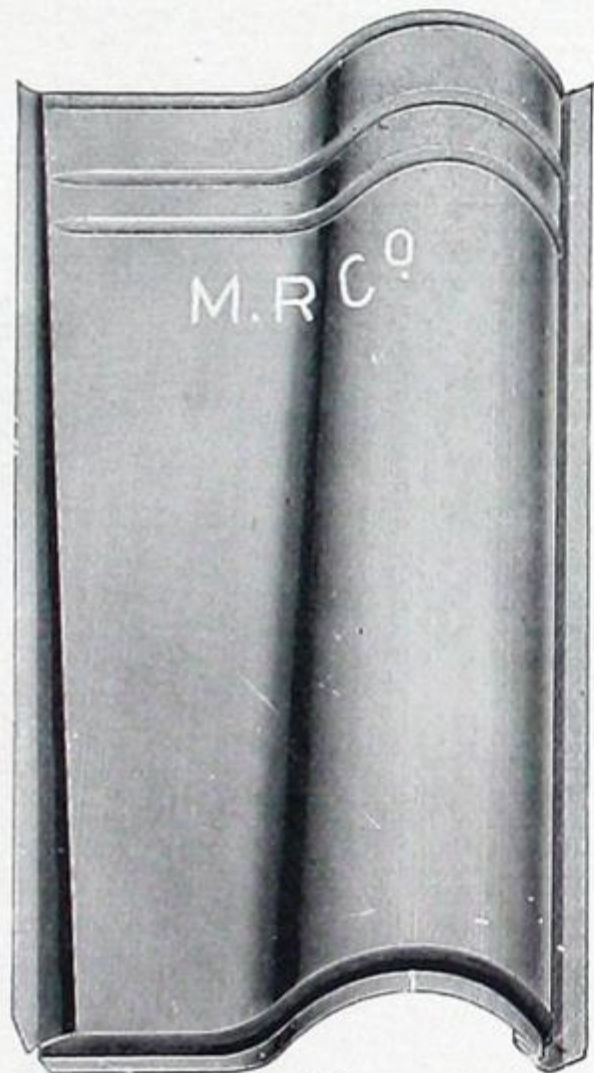

Fig. 21.

Illustration above shows one single sheet of our "Eureka" Spanish Tile.

"Eureka" Spanish Tiles.

SUITABLE for covering steeples, towers, mansards, or roofs having not less than one-quarter pitch. Made from the best of soft stamping **tinned** steel plate, either painted or galvanized, or from sheet copper. Tiles cover when laid $12\frac{1}{2} \times 7\frac{1}{2}$ inches each, 174 sheets to a square, covering one hundred square feet.

Approximate average weight of the painted tiles, about ninety pounds per square; shipping weight about 105 pounds per square. Approximate average weight of galvanized tiles, about one hundred pounds per square; shipping weight, about 115 pounds per square.

These tiles are very bold in design, with a heavy butt, and possess all the characteristic features and artistic beauty of the terra cotta tile of the same pattern, with none of its disadvantages.

The weight of these tiles is only about one-eighth that of earthen tiles; consequently they do not require nearly so strong a roof or sub-structure. Unlike clay tiles, they are not easily broken, nor liable to become detached, neither have they any cemented joints to crack or open.

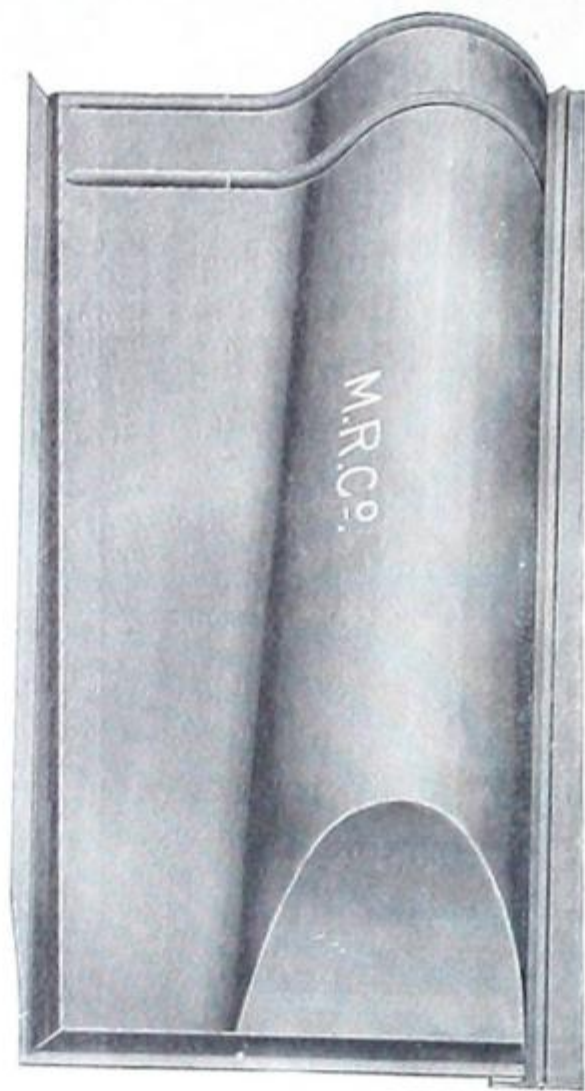

Fig. 22.

"Eureka" Spanish Tiles with closed ends are made for the first or eave course, as shown in the above illustration. In ordering always state the total length of eave to be covered, so that the correct quantity of starters may be sent.

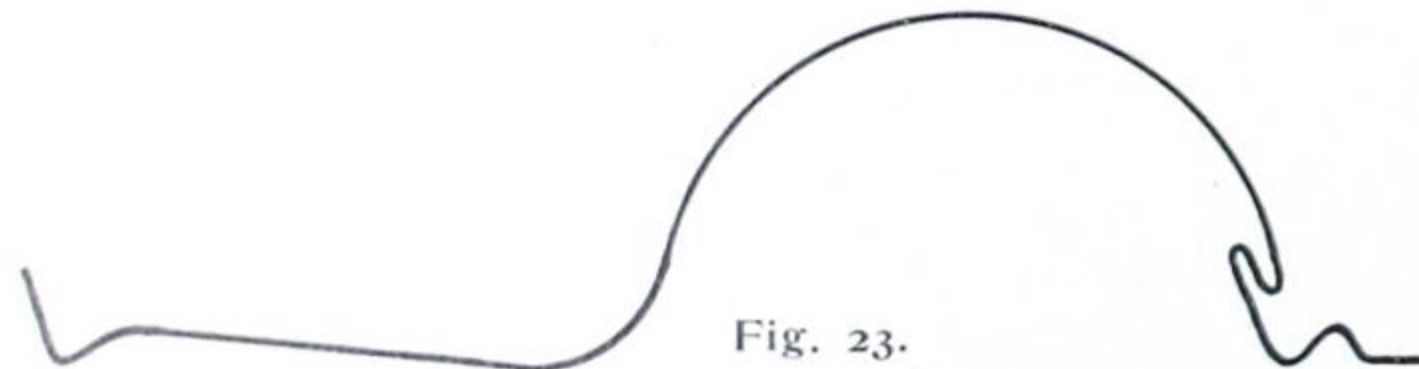

Fig. 23.

End view of our Spanish Tile (one-half actual size), showing the amount of raise of the curved portion, also the method of uniting the tiles together by means of the side lock. As will be seen from the illustration, the lock is formed on the curved portion of the tile, throwing water **away from**, instead of **to the lock**, and as all nail heads are covered, and every course lies close to the overlapping one, there is no possibility of there being any leakage anywhere. Ample provision is also made for contraction and expansion of the metal.



Fig. 24.

Illustrates six sheets of our "Eureka" Spanish Tiles put together, commencing at the eave.



Fig. 25.

Spanish Tile Hip Cap, for use with either our Spanish, Diamond, or Gothic Tiles.

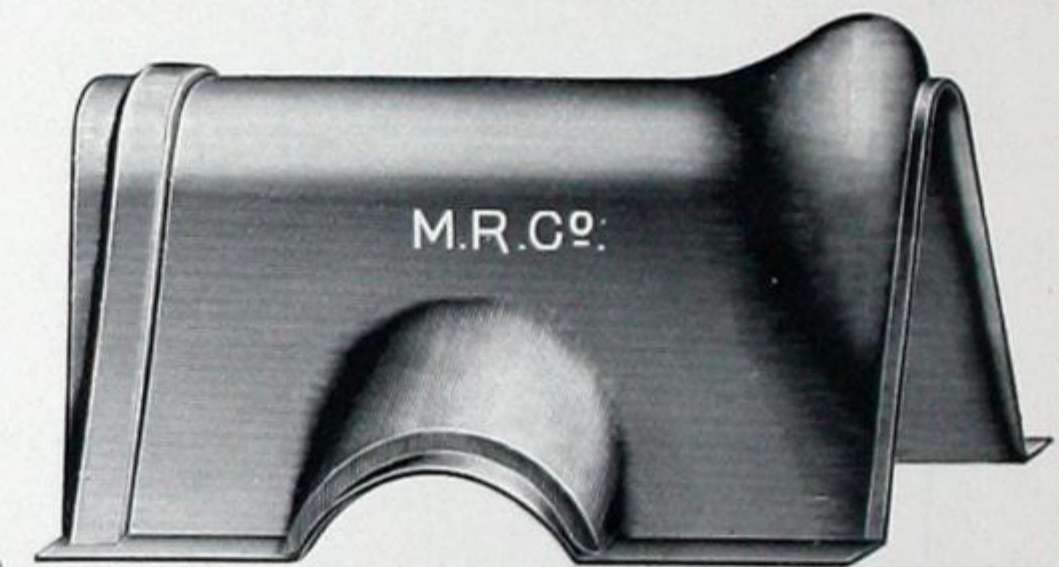

Fig. 26.

Spanish Tile Ridge Cap, for use with our Spanish Tile.

“Eureka” Graduated Spanish Tiles.

MADE from **tinned** steel, painted or galvanized, or from sheet copper.

We also make Spanish Tiles specially graduated to suit circular towers.

Each course is specially graduated to suit where it is intended to go, so that an even number of tiles will work out around the tower, and is numbered to correspond with a plan, which we send out with the invoice, making it a simple matter for any mechanic to apply the goods. A sketch of tower, giving exact diameter and length of rafter, must accompany each order.

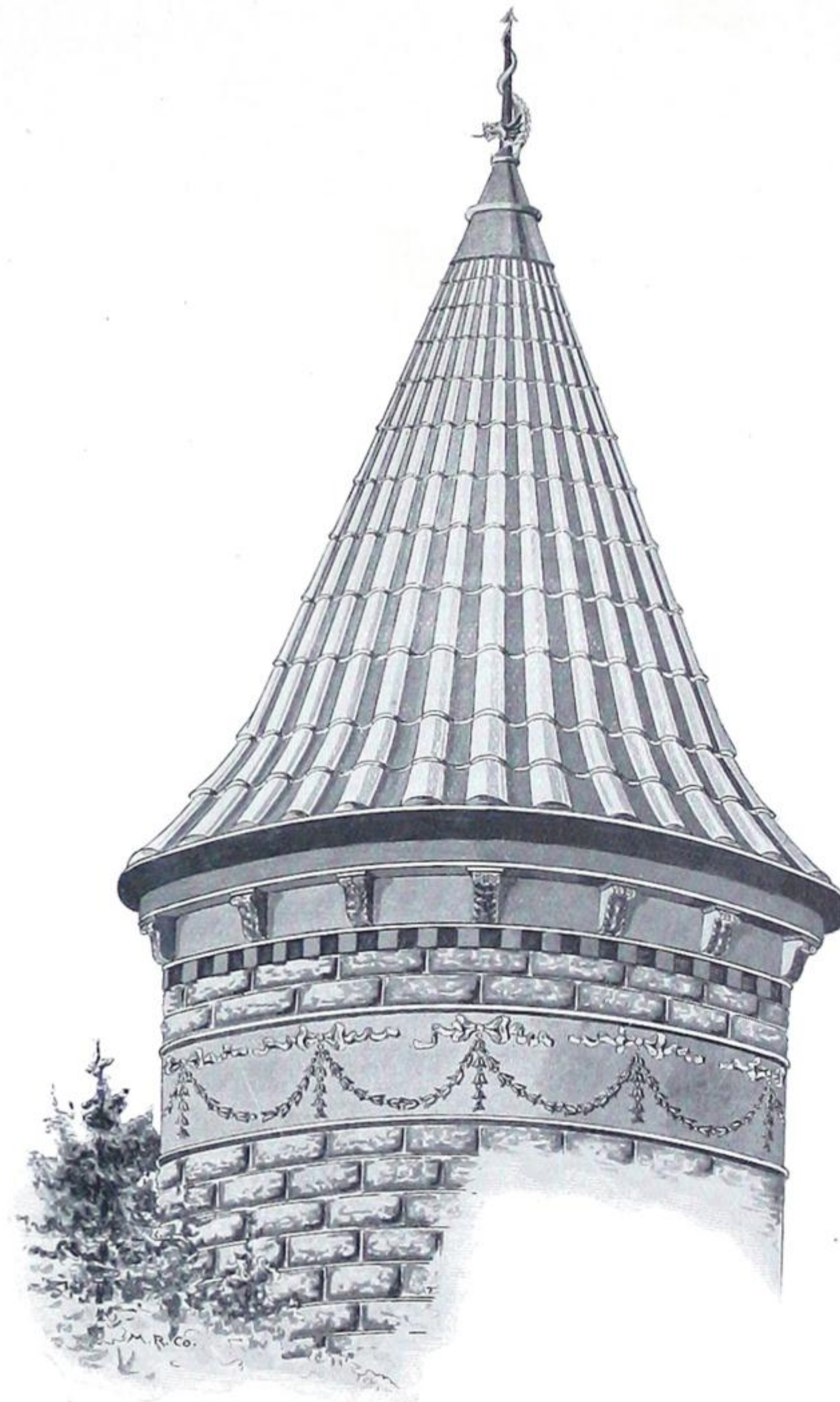

Fig. 27.

Illustrates a Circular Tower covered with our Graduated Spanish Tiles.

"Eureka" Diamond Tiles.

Suitable for Covering Towers, Steeples, Mansards, Gables, etc.

MADE from finest soft stamping **tinned** steel, either galvanized or painted, or from sheet copper.

Tiles cover when laid 6 x 6 inches each; 400 sheets to a square, covering 100 square feet.

Approximate average weight of the painted tiles about 78 lbs., and of the galvanized tiles about 90 lbs. per square; shipping weights about 90 lbs. and 100 lbs. respectively.

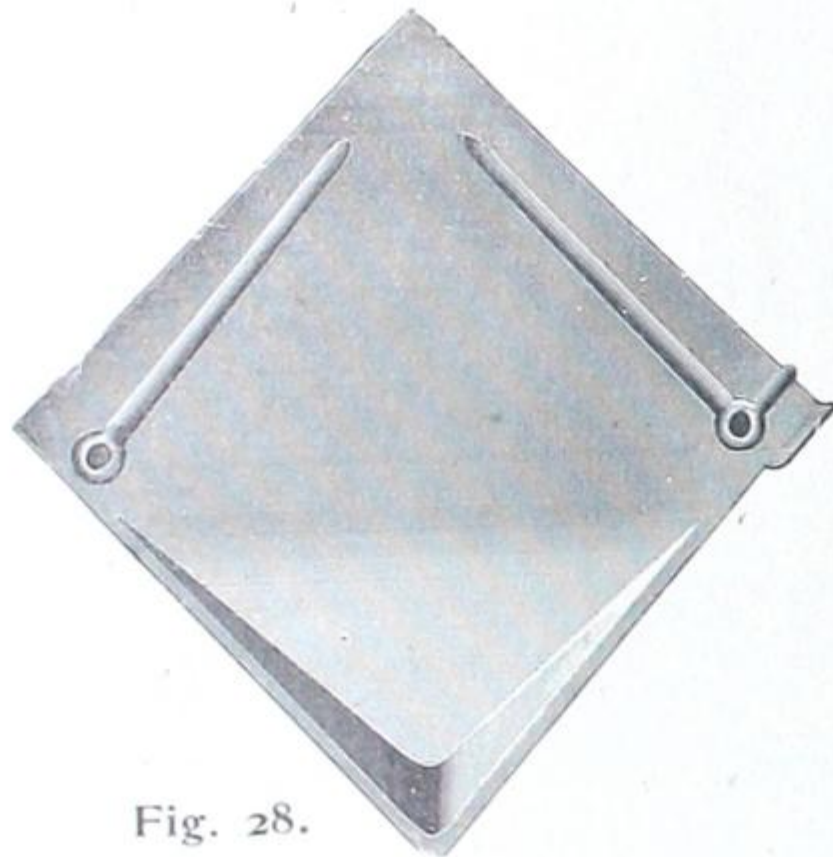

Fig. 28.

along the upper edges which stiffen the sheets, showing where to nail, and also serving as a guide to the roofer in laying; while the lower corner of each tile is securely held in position by a **lug, formed out of the body of the sheet itself**, which is bent over from the adjoining lower course, thus covering up all the nail heads, and rendering it impossible for the lower part to either warp or raise up.

The construction and bold relief on the "Eureka" Diamond Tiles will not admit of anything but the very finest of stock being used in their manufacture. The material being first heavily **tinned**, both in the galvanized and painted tiles, is amply protected, in addition to the coating of painting or galvanizing, as the case may be; consequently they cannot fail to be exceedingly durable. Any question as to this tinned coating on these tiles can be easily set at rest by scraping some of the paint from their surface. The galvanized tiles do not require any painting to preserve the metal.

Fig. 28 shows one single sheet of "Eureka" Diamond Tiles.

The design of these tiles is artistic, and **very bold, showing a raised butt about one inch high**, which stands out in such relief as to be plainly seen from the ground, even on the highest tower.

The architectural features of these tiles cannot be surpassed, and they will, we feel sure, merit the approval and confidence of architects and builders generally.

Each sheet is provided with corrugations and indentations

The **painted tiles** are thoroughly coated **on both sides** with a specially prepared **terra cotta colored paint**, mixed with pure linseed oil and turpentine, and have every appearance of the best terra cotta tiles. As there is no wear on the under side of the metal, a periodical coat of paint on the outer surface will preserve them indefinitely.

"Eureka" Diamond Tiles are light in weight, will not warp, crack, nor drop off, besides being **fire-proof**, and can be laid by any-one of ordinary intelligence, while ample provision is made for contraction and expansion.

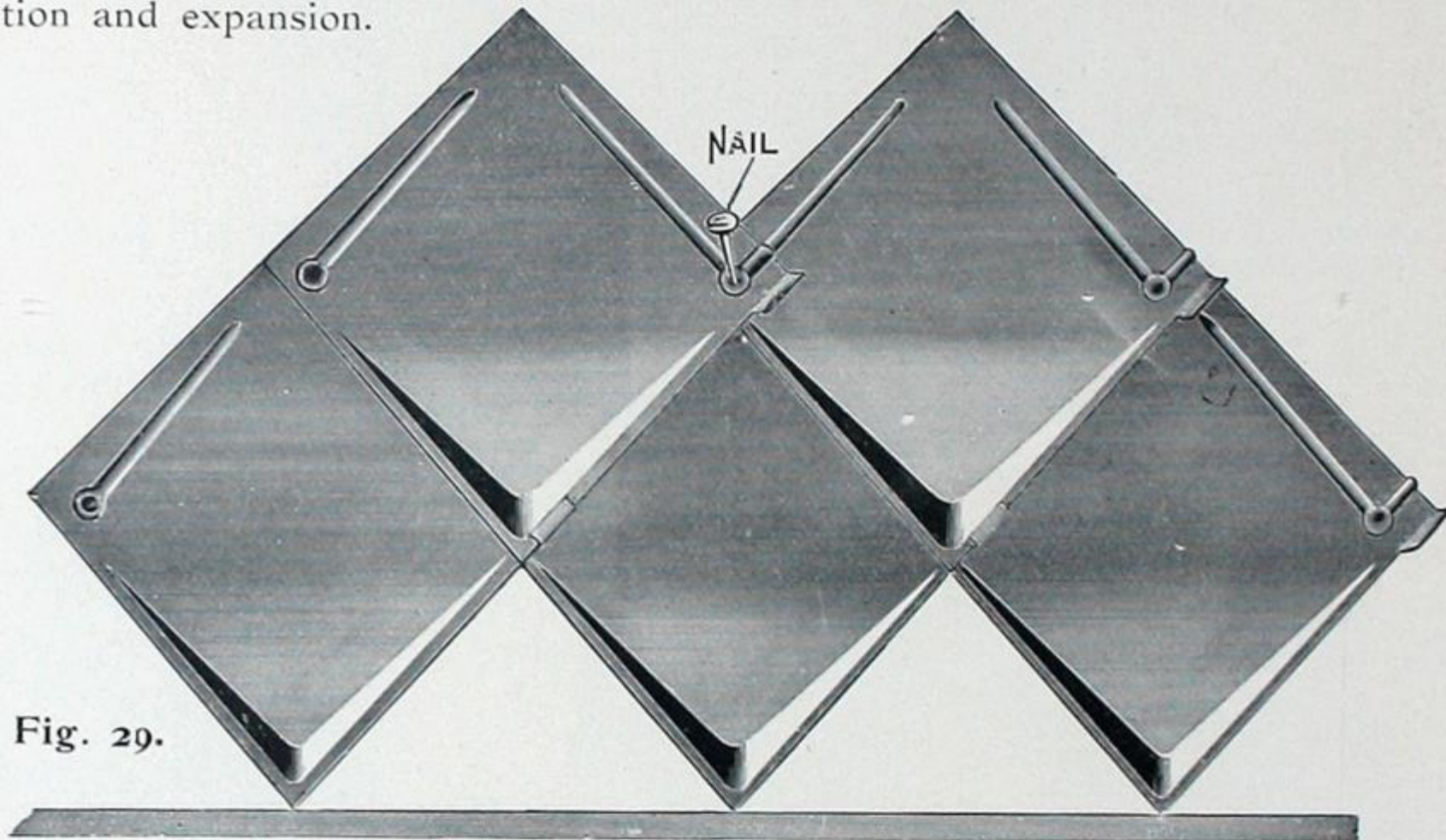

Fig. 29.

Illustration represents a cluster of five "Eureka" Diamond Tiles put together, which, as will be seen, are laid diagonally. Also shows where to nail and the lug on one corner of each tile, bent over in position to hold down the bottom of the overlapping tile.

A plain strip of iron, tin, or copper may be used in starting the first course, or the tiles can be cut in half in the centre horizontally from corner to corner, the upper half of tiles so cut being used alternately with the full sheets for starting, and the bottom half will be required to finish at the top.

Specify and insist on getting "Eureka" Diamond Tiles. There may be others, but none are equal to them in any respect.

**“Eureka”
Graduated
Diamond
Tiles.**

Made from **tinned** steel,
painted or galvanized,
or from sheet copper.

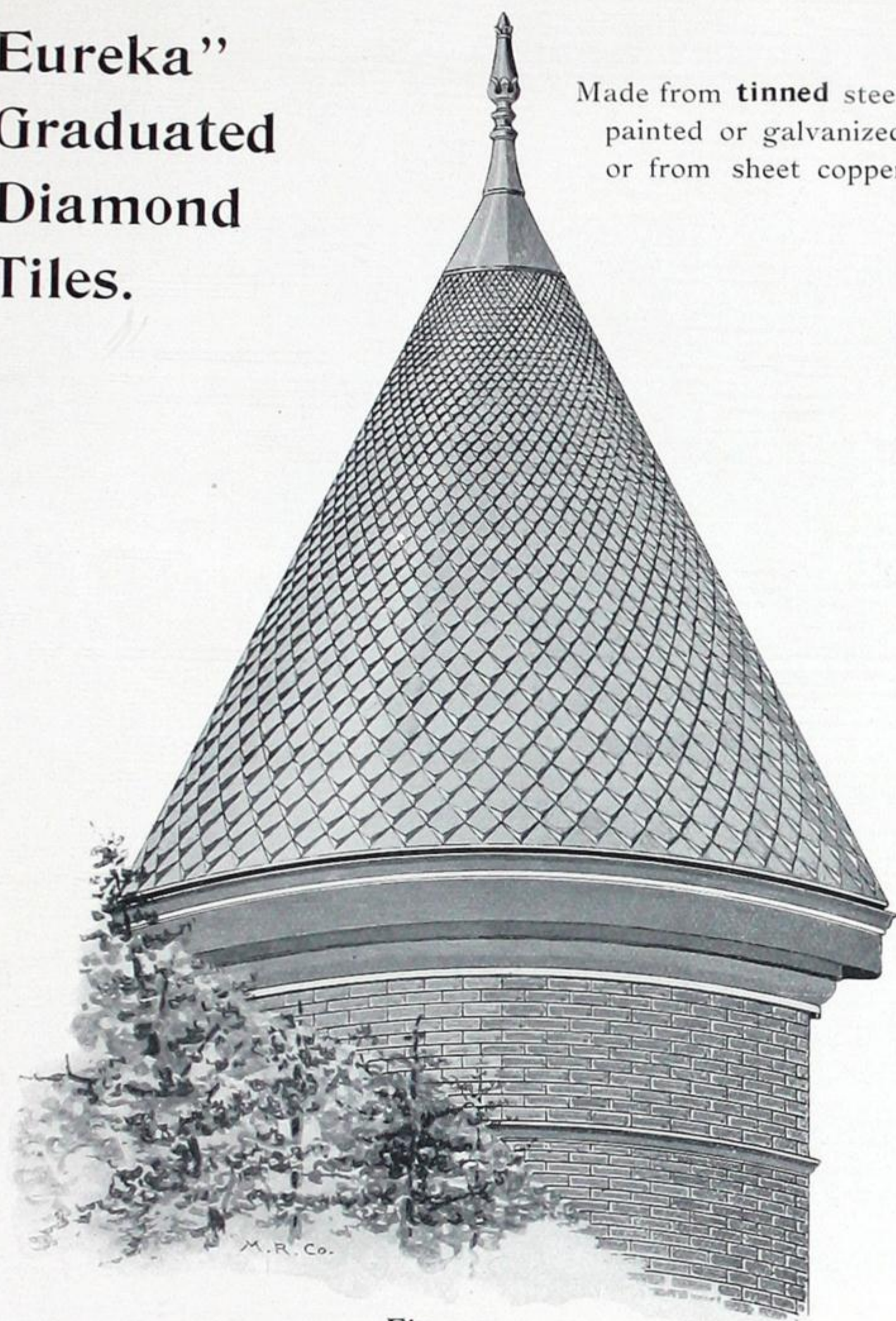

Fig. 30.

Illustrates a tower covered with Graduated Diamond Tiles. Each course is made up specially to suit where it is intended to go, so that an even number of tiles will work out around the tower. The courses are numbered to correspond with a plan, which we send out with each shipment, making it a very simple matter for any mechanic to apply the goods. A sketch of tower, giving exact diameter and length of rafter, must accompany each order.

“Eureka” Diamond Tiles.



Fig. 31.

The above illustration is an exact reproduction from a photo of a summer house, the roof of which is covered with our “Eureka” Diamond Tiles, at the residence of Francis J. Phillips, Esq., No. 63 Queen's Park, Toronto.



Fig. 32.

Conservatory at Residence of A. R. Creelman, Esq., Queen's Park, Toronto.

Roofed with our "Eureka" Diamond Tiles.

Interior covered with our Embossed Steel Plates.

“Eureka” Gothic Tiles.

Suitable for Covering Towers, Steeples, Mansards, Gables, etc., etc.

MADE from finest soft stamping **tinned** steel, either painted or galvanized, or from sheet copper. Tiles cover when laid 6 x 6 inches each; four hundred sheets to a square, covering one hundred square feet.

Approximate average weight of the painted tiles, about seventy-eight pounds, and of the galvanized tiles about ninety pounds, per square; shipping weight, about ten pounds per square additional in each case.

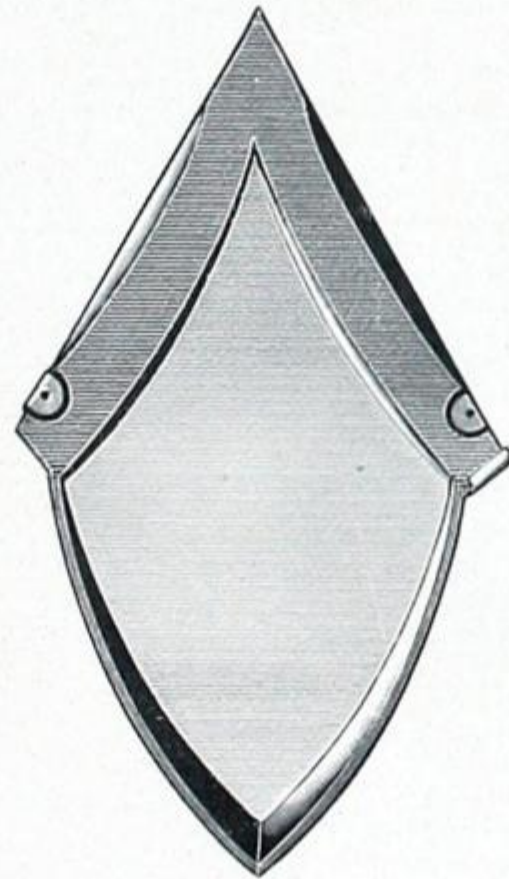

Fig. 33.

Illustration shows one single sheet of “Eureka” Gothic Tiles.

The design of these tiles is of the Gothic style, and is very bold.

Like our Diamond Tiles, each sheet is provided with corrugations and indentations along the upper edges, which stiffen the sheets, showing

where to nail, and also serving as a guide to the roofer in laying; while the lower edge of each tile is securely held in position by a **lug**, formed out of the body of the sheet itself, which is bent over from the adjoining course below, thus covering up all nail heads, and rendering it impossible for the lower part to either warp or raise up.



Fig. 34.

Illustrates five sheets of our Gothic Tiles put together, showing where to nail, and also lug on the corner of each tile bent over in position to hold down the bottom of the overlapping tile.

For the starting strip, a plain piece of metal is used, or the tiles may be cut in two; the piece cut off the bottom course working in up at the top of roof.

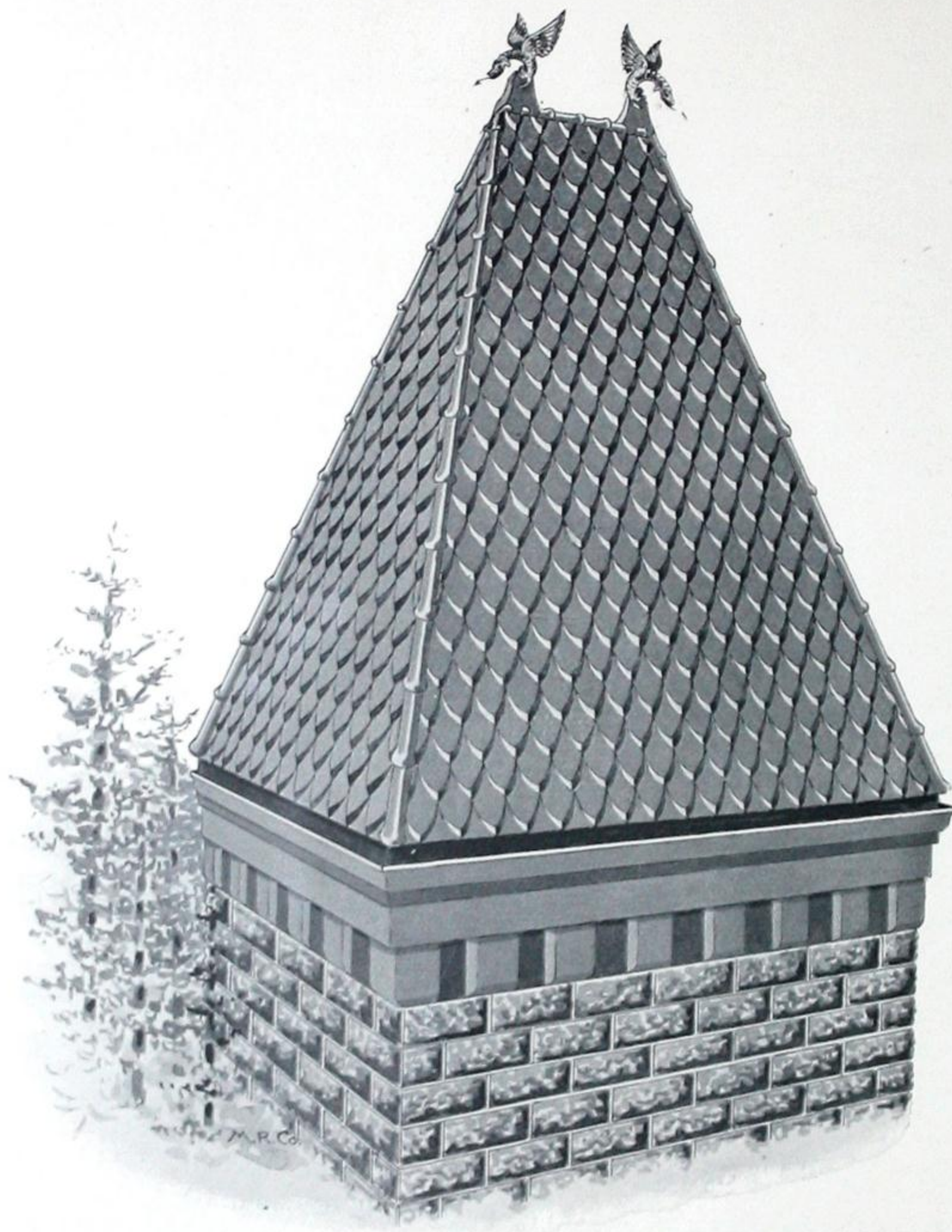

Fig. 35

Shows our "Eureka" Gothic Tiles as applied to a tower.

Pressed Double Cap Roofing.

Galvanized or Painted.

Adapted for Covering all Descriptions of Roofs having a Pitch of not less than One Inch to the Foot.

MADE from the finest quality of thoroughly coated **galvanized** sheet steel in 26 or 28 gauge, or from cold rolled black steel sheets, 26 or 28 gauge, thoroughly coated on both sides with our magnetic oxide of iron paint.

Weight, from about 80 to 100 pounds to the square, according to the gauge of metal used.



Fig. 36.

A sheet of Pressed Double Cap Roofing as shipped. Six sheets of **galvanized** roofing constitute a square; size, 96 x 26½ inches each.

Painted roofing, 6 sheets to a square, each 96 x 26½ inches, or 8 sheets 72 x 26½ inches each. These are the standard sizes of sheets, but any size can be supplied, up to sheets 10 feet in length, if specially ordered.

In laying the roofing, the cap on one side of the sheet fits over the cleats and cap on the adjoining sheet; the whole seam is then squeezed together and punched about three-eighths of an inch down from the top of the cap, at intervals of about every 12 inches, and then rivetted solidly together, with either copper or tinned rivets and burrs.

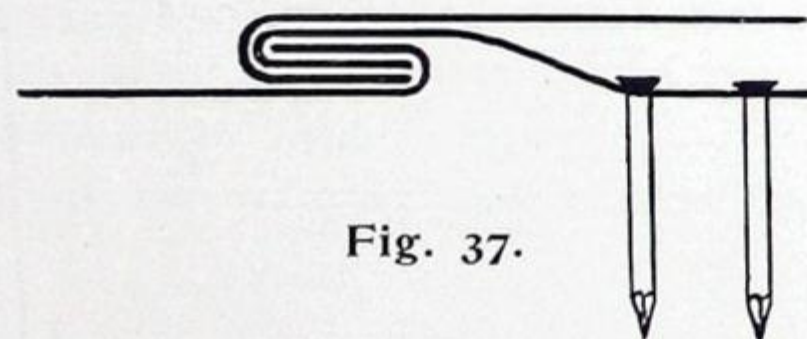

Fig. 37.

Cross lock at end of sheets, showing end cleat in position. At the ends of the sheets a cross lock is turned, as shown (Fig. 37) when roofing is being laid, with an end former (sent with the goods when desired), so that the bottom edge

of the upper sheet hooks over the end cleats into the lock formed on the top edge of the lower sheet, and the lock seam thus formed should be malletted down tight.

Any handy man can lay this form of roofing, which goes together very rapidly.

We advise that all roofing be laid over a ply of good building paper ("Aquaprobe" preferred). The additional cost is trifling, and it makes a better job in every way.

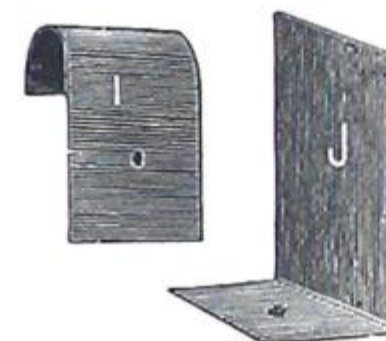

Fig. 38.

I is the cleat used at end of sheets, and **J** is the standing cleat used at the sides. Sufficient cleats are sent with each shipment free of charge. The sheets should be cleated down to the roof boards at intervals of about every 12 inches, and at the end of each sheet three cleats should be used, hooking them into the lock, one in the centre and one next each cap; always using two nails to each cleat.

All cleats are entirely covered by the adjoining sheets, and as no nailing is done in the roofing itself, ample provision is made for contraction and expansion.

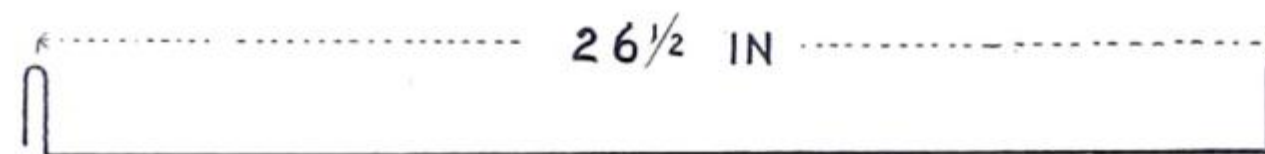

Fig. 39.

End View of Sheet of "Pressed Double Cap Roofing."

The sheets are formed with a standing cap, 1 inch high on each side, as shown in above illustration, and being all **accurately squared** and made on special machinery, they are all of an exactly uniform size, fitting together perfectly on all four sides.



Pressed Double Cap Roofing.

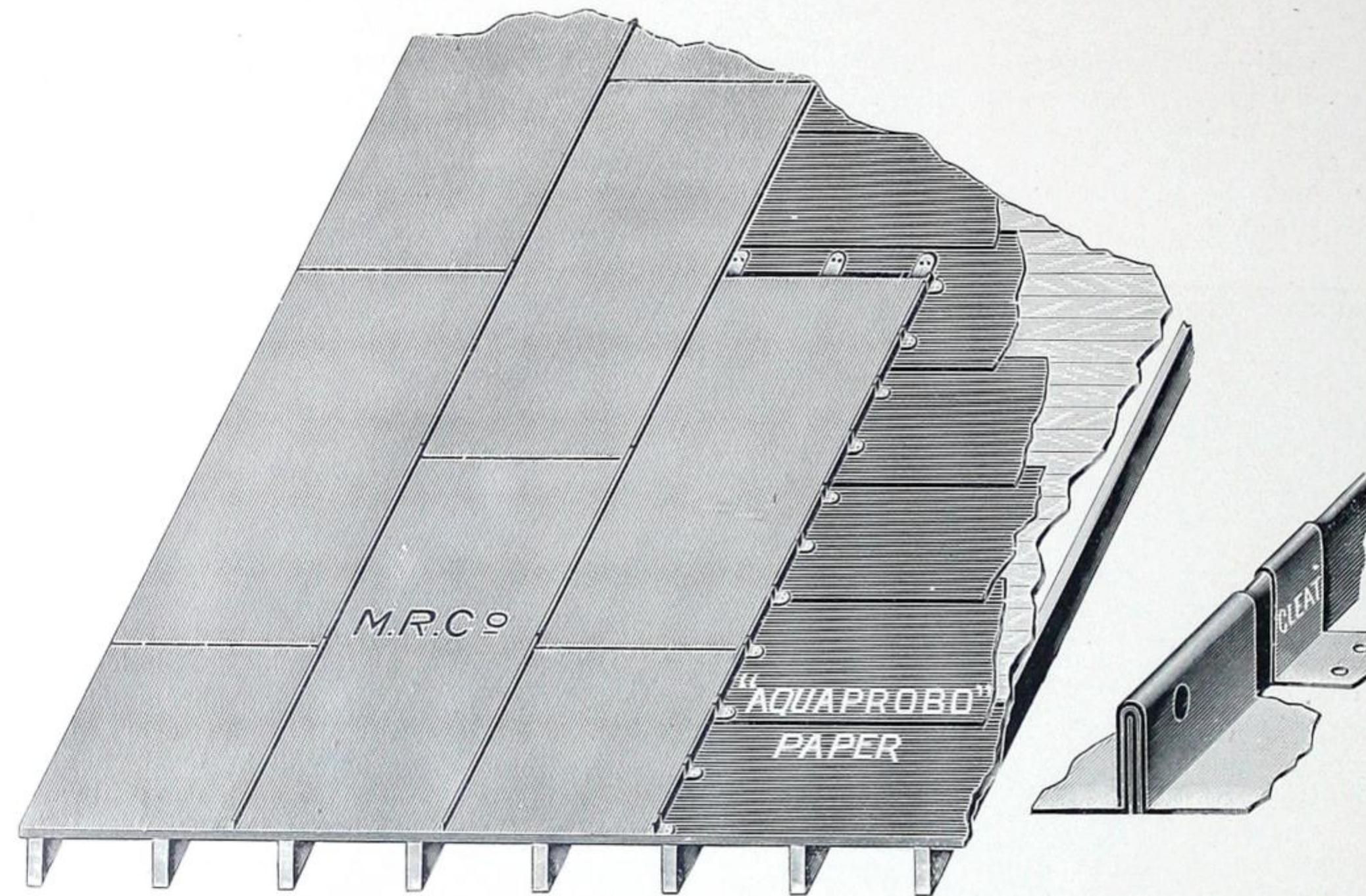

Fig. 40.

Application of Pressed Double Cap Roofing, showing the seam all complete, rivetted together, also the side and end cleats in position.

With every shipment of "Pressed Double Cap Roofing" (when so ordered) we send, on loan, our own improved patented combination squeezing and punching tool, together with end former. These tools are loaned on the express condition that they will only be used for putting on our goods, and that they will be returned promptly, charges prepaid. If not actually returned within 30 days from date of invoice, (unless specially arranged for at time of sale) a rental of \$1.00 per day will be charged for each and every additional day tools are retained, and we make this a strict condition in loaning these tools.

Illustrations and full description of tools on page 18.

Ready Roll Cap Roofing.

Suitable for Covering all kinds of Flat Roofs having a Pitch of not less than One Inch to the Foot.

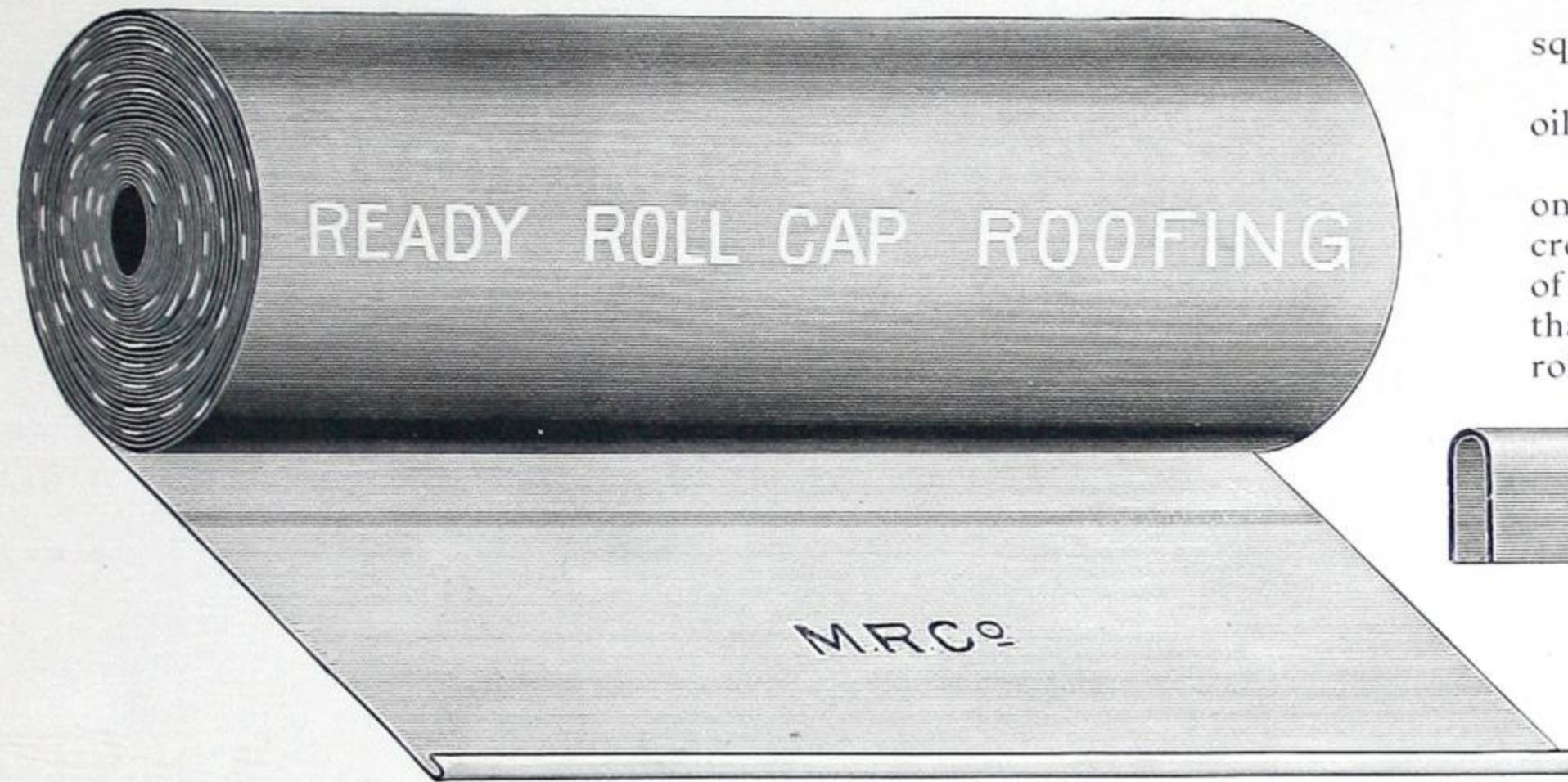

Fig. 41.

MADE from best of **galvanized** steel, or from **prime terne plate** (lead coated), in rolls any length to suit the roof. Galvanized roofing is twenty-four inches wide. Terne plate roofing is twenty inches wide.

Weight of the galvanized, about ninety-five pounds per square, and of the terne, about sixty-five pounds per square.

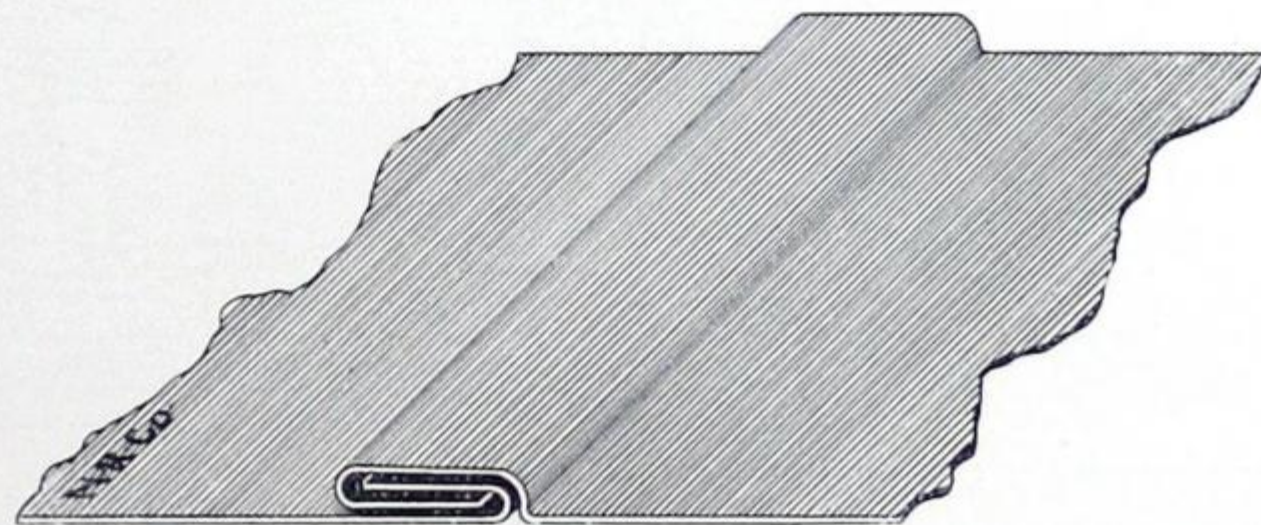

Fig. 42.—Section showing the Cross Seam.



Fig. 43.

Shows the Ready Cap as shipped to go over the standing seam, where the two rolls unite at the sides. Sufficient caps, all formed, are sent with each shipment.

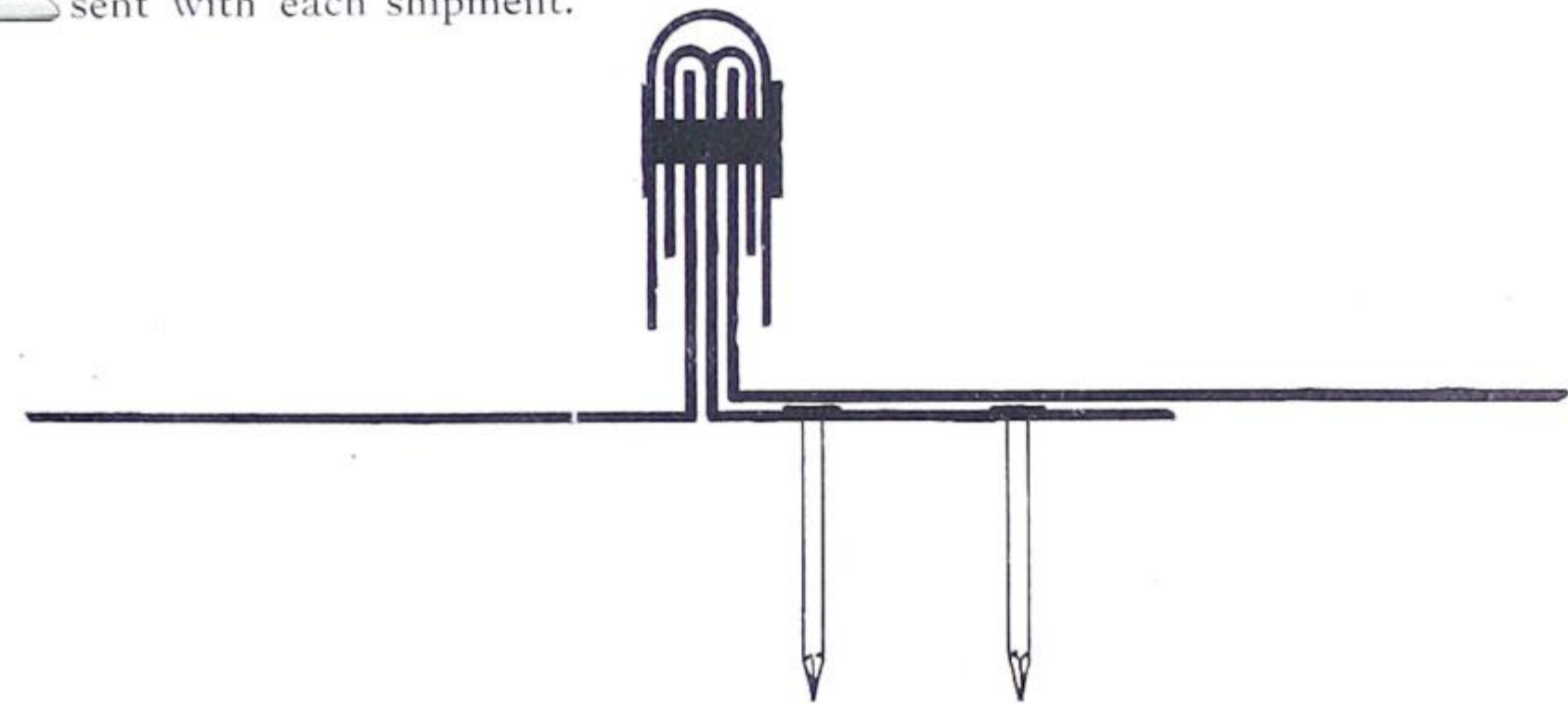

Fig. 44.—Shows Standing Seam complete with Cleat, and Rivetted.

A standing seam $1\frac{1}{4}$ inches high, is turned up on each side of the roll at right angles to the body of metal, as shown in the above illustration, when the roofing is being laid.

THE METALLIC ROOFING COMPANY OF CANADA, LIMITED, TORONTO, CANADA.

Fig. 45 shows cleat used with our Ready Roll Cap Roofing, split in the centre, which goes between the rolls, being placed at intervals of about every twelve inches. Each cleat is nailed to the sheeting with at least two nails, and one half of the standing part of it is turned down tightly over the standing seam formed on one side of the roll of roofing, and the other half over the standing seam on the adjoining roll. (See Section, Fig. 44.) Sufficient cleats are sent with each shipment.

After the rolls have been joined together and cleated down, each standing seam is covered over with the cap, as shown in Fig. 43; commencing at the eave and overlapping the lengths at the ends about one inch, and the whole seam is then punched at intervals of about every twelve inches and securely rivetted together, using either copper or tinned rivets and burrs.

In ordering send sketch of roof, with accurate measurements marked on it, showing which way it pitches, also location of fire walls (if any), and roofing will be made to just suit the requirements.

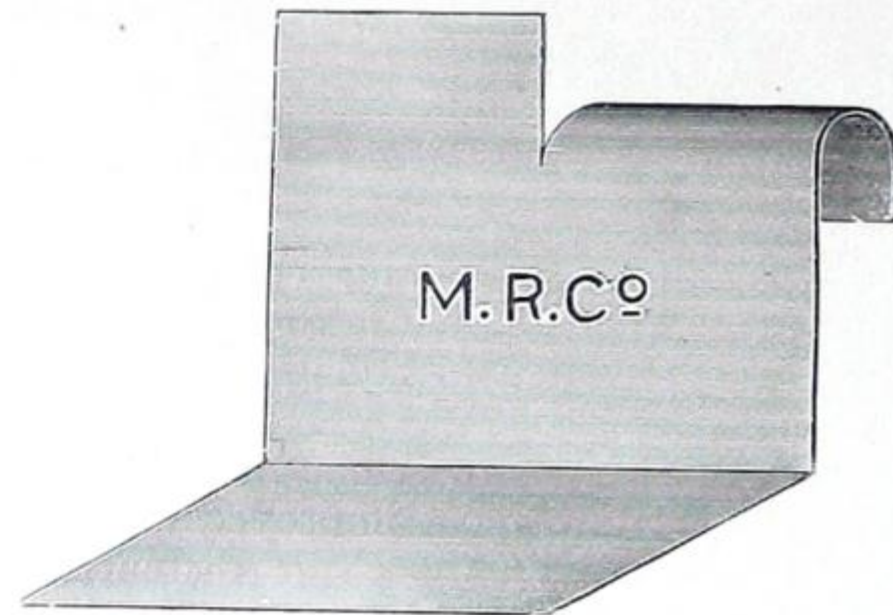

Fig. 45.

When so ordered, we send on loan, with each shipment of this roofing, our own improved patented combination squeezing and punching tool, together with edging tongs for turning standing seams. These tools are loaned on the express condition, that they will be only used for putting on our goods, and that they will be returned promptly, charges prepaid. If not actually returned within thirty days from date of invoice, (unless specially arranged for at time of sale), a rental of \$1.00 per day will be charged for tools are retained, and in loaning these tools. Illustrations and full descriptions of tools on page 18.

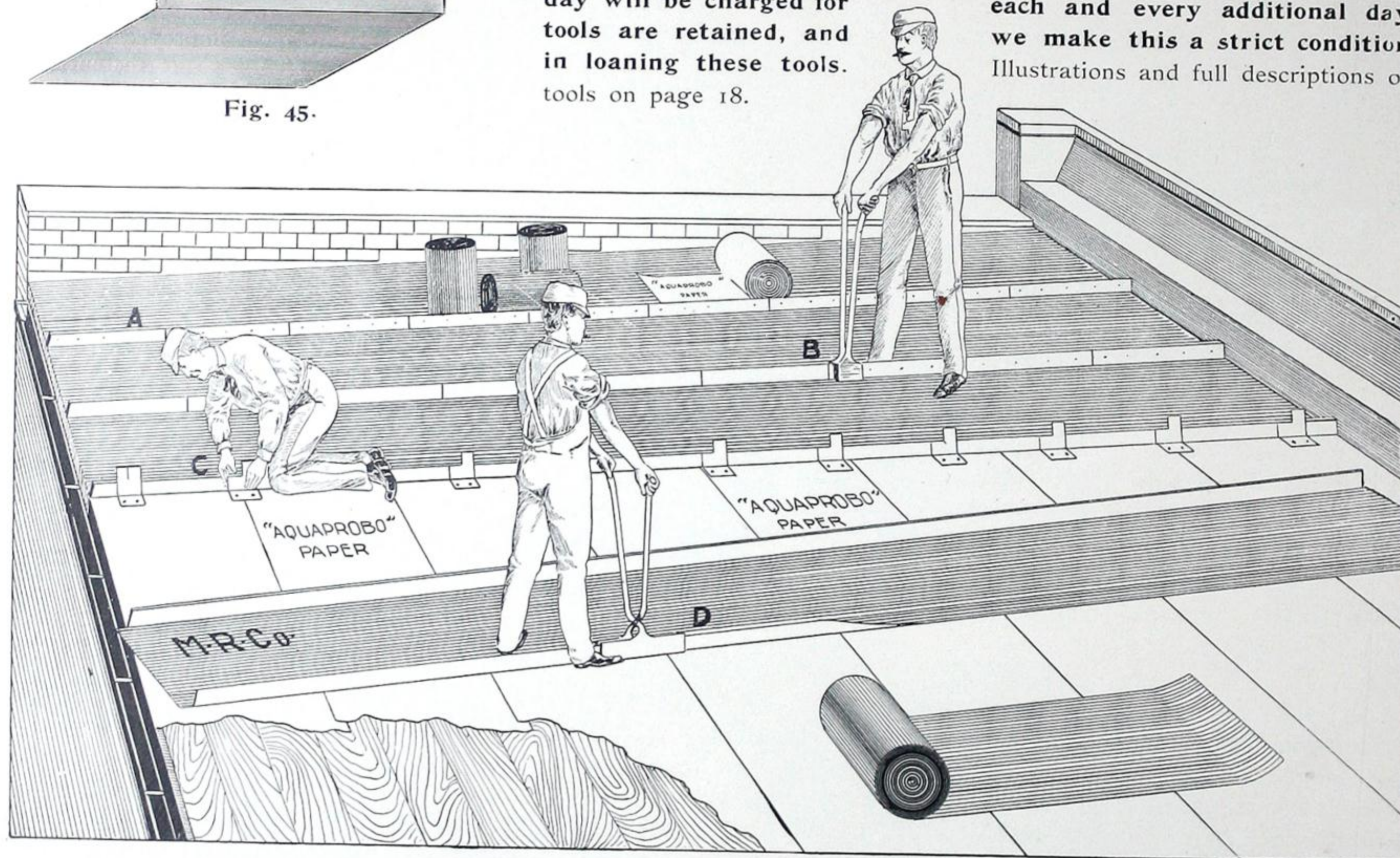

Fig. 46.—Ready Roll Cap Roofing in Process of Laying.
 A—Cap finished. B—Squeezing and Punching. C—Cleating. D—Turning up seam.

V Crimped Iron Roofing.

Painted or Galvanized.

SUITABLE for Barns, Saw Mills, Elevators, Rolling Mills, Smelters, etc. Can be used on any roof having a pitch of one-sixth or over. This form of roofing may be laid on sheeting or applied direct to the rafters, or it may be laid on battens nailed across the top of the rafters.



Fig. 47.

The above illustration shows a sheet of roofing as shipped.

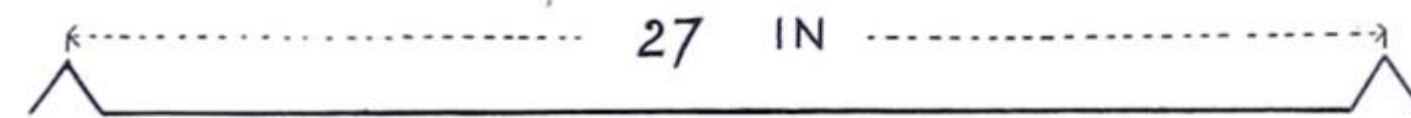

Fig. 48.

End View of Sheet of V Crimped Roofing.

Standard size of sheets, six or eight feet long by twenty-seven inches from centre to centre of outside crimps. Any size of sheets up to ten feet long can be furnished to order.

Eight sheets six feet long to a square.

Six sheets eight feet long to a square.

Weight depending on gauge of metal used.

V Three Crimped Roofing.

Galvanized or Painted.

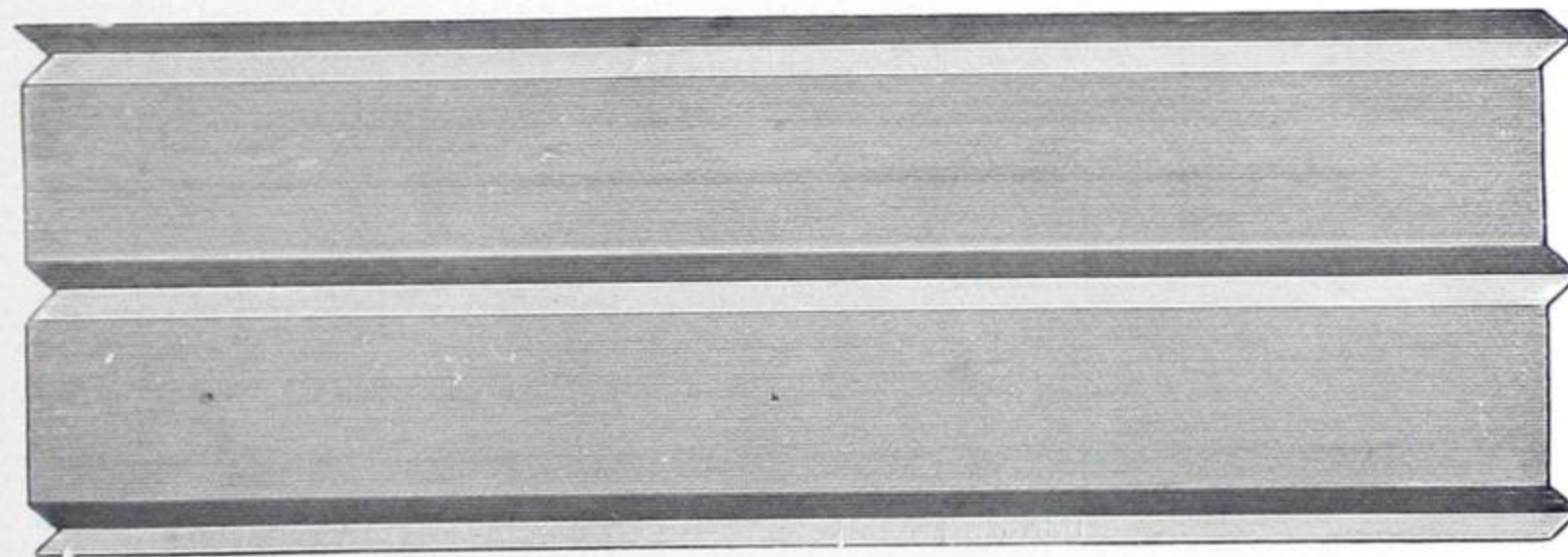

Fig. 49.

This style of roofing is also made with a crimp in the centre of the sheets, as shown above, which materially stiffens the sheets.

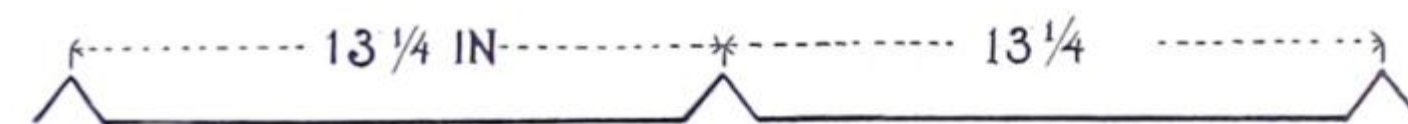

Fig. 50.

End View of Sheet of V Three Crimped Roofing.

Standard sizes of sheets six or eight feet long by $26\frac{1}{2}$ inches wide from centre to centre of outside crimps, and $13\frac{1}{4}$ inches from centre of outside crimp to centre of middle crimp; eight sheets six feet long or six sheets eight feet long constitute a square.

In both the V Crimped and V Three Crimped Roofing, the sheets are formed with a V shaped crimp on each side, and when applied to

THE METALLIC ROOFING COMPANY OF CANADA, LIMITED, TORONTO, CANADA.

the roof, the crimp on one side of a sheet overlaps the crimp on the side of the adjoining sheet, and are then nailed with wire nails through a triangular strip of wood into the sheathing or wood support.



Fig. 51.

Shows piece of Triangular Wood Strip made in Lengths of eight feet.

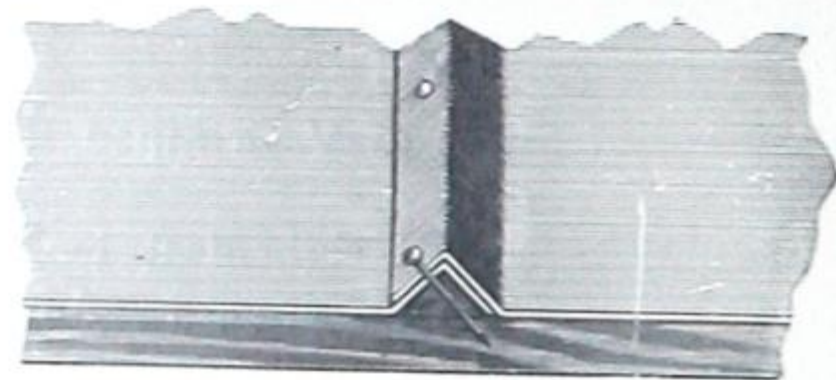

Fig. 52.

The nails are driven through the top part of the crimp, as shown in illustration, and above where the water runs, making leakage an impossibility, and at the same time amply providing for contraction and expansion of the metal.

The ends of the sheets should either be lapped about three inches and nailed securely, as in Fig. 53, or hook locks can be formed, as in Fig. 54; the latter is the better way and requires less material.



Fig. 53.

Shows Lap Joint as nailed.



Fig. 54.

Shows Lock Joint as applied to Sheathing.

Both styles of V Crimped Roofing are so simple in their construction and application that anyone of ordinary intelligence can apply them very rapidly. One handy man should turn the end locks and lay at least from ten to twelve squares in a day, the only tools required being a hammer and a pair of tinner's snips, except where ends

of sheets are to be locked, in which case we send an end former, for which we charge \$1.50, but if returned promptly, freight prepaid, the full price charged will be refunded.

One pound of nails (two-inch twelve-gauge) is more than sufficient for laying a square.

For barn roofs or elevators we would recommend close sheeting; rough culled lumber will do, so long as it is sound and will hold the nails firm.

V Crimped Roofing takes fifty lineal feet, and V Three Crimped Roofing requires one hundred lineal feet, of triangular wood strips to do a square. We can supply these strips when ordered at lowest prices.

The Painted Roofings are thoroughly coated on both sides with our standard quality of magnetic oxide of iron paint, mixed with pure linseed oil and turpentine. (See page 16, "Painting.")

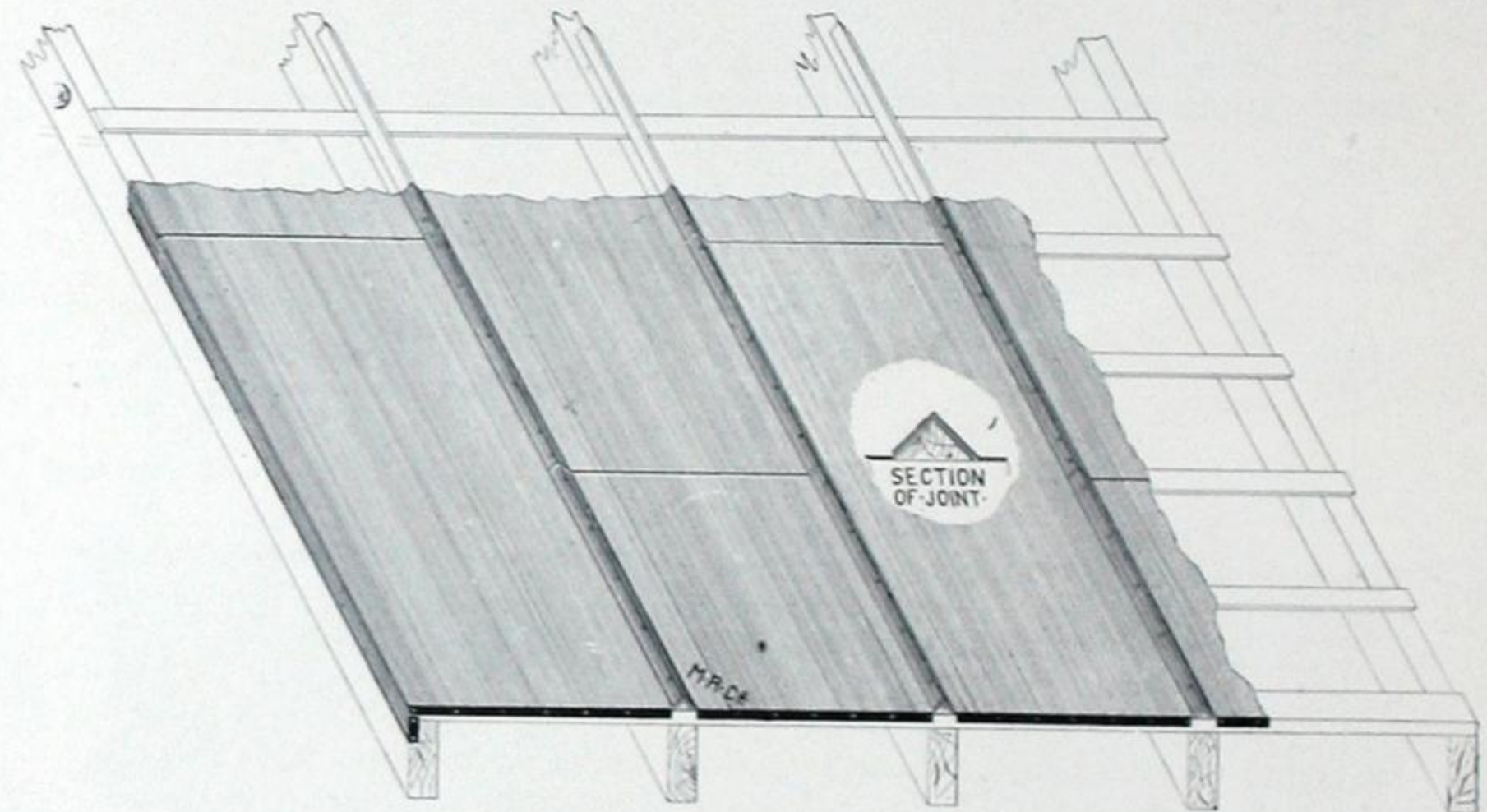

Fig. 55.

Shows application of V Crimped Roofing, without using Sheathing.

Strips three or four inches wide are placed the proper distance apart (depending on the gauge of the metal and size of sheet used), being nailed across the top of the rafters, and the roofing is nailed to these battens.

THE METALLIC ROOFING COMPANY OF CANADA, LIMITED, TORONTO, CANADA.

“Our Special” Rock-Faced Steel Siding.

Galvanized or Painted.

HIGHLY recommended for covering the exterior walls of buildings, particularly dwellings, **store or business fronts**, foundations, etc., etc., making a dry, warm, fire-proof covering that will not crack nor drop off, and one that, when painted a stone color, cannot be distinguished from solid, rock-faced stone.

Made from an extra soft grade of stamping steel, in exact representation of the best of rock-faced stone. The lines are sharp and clear, in places being raised up from the body of the plate about three-quarters of an inch.

One grade of galvanized and one grade of painted only. **Approximate average weight** of the **painted**, about sixty-five pounds per square, and of the **galvanized**, about ninety pounds per square; shipping weights, about ten pounds per square additional in each case.

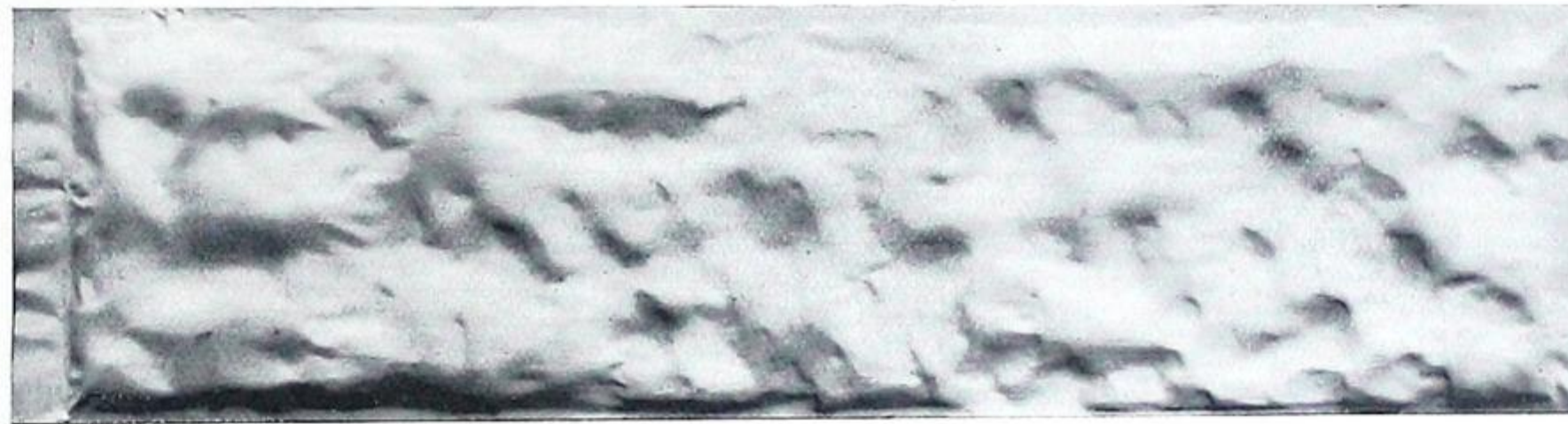

Fig. 56.

Photographic Reproduction from One Single Sheet.

Covering size, twenty-six inches long, with seven-inch face; seventy-nine sheets to a square.

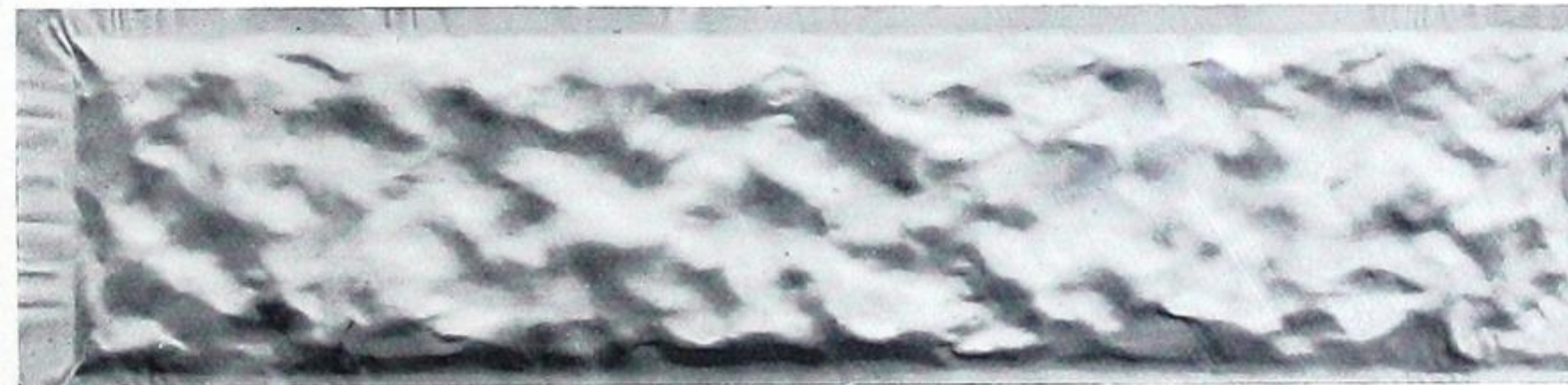

Fig. 57.

Photographic Reproduction from One Single Sheet.

Covering size, twenty-six inches long, with six-inch face; ninety-two sheets to a square.





“Our Special” Rock-Faced Steel Siding.

(See also page 41.)



Fig. 58.

Photographic Reproduction from One Single Sheet.

Covering size, twenty-six inches long, with five-inch face; 111 sheets to a square.

THE sheets are made with a plain flange all around, which, when laying, overlap each other, so as to show a plain strip of about a quarter of an inch between the stones, and are nailed with small wire nails where they overlap.

All joints are broken and are unnoticeable. The three sizes may be used in combination on the same job; first, a seven-inch course, then a six-inch, and next a five-inch, or, the laying of the different courses may be varied to suit the taste.

Painted siding is thoroughly coated on both sides with our regular reddish brown oxide of iron paint, mixed only with pure linseed oil and turpentine, which is the best preservative for the metal, for the foundation coat. After laying, paint the siding any shade desired, and before the paint is set, blow on fine screened lake sand by using a small bellows. The sand will adhere to the paint, giving the work a rough, genuine stone finish.

In ordering always be careful to state the size wanted, or, if more than one size is required, the quantity of each. If no size is mentioned, we take it that the size is left to our discretion.

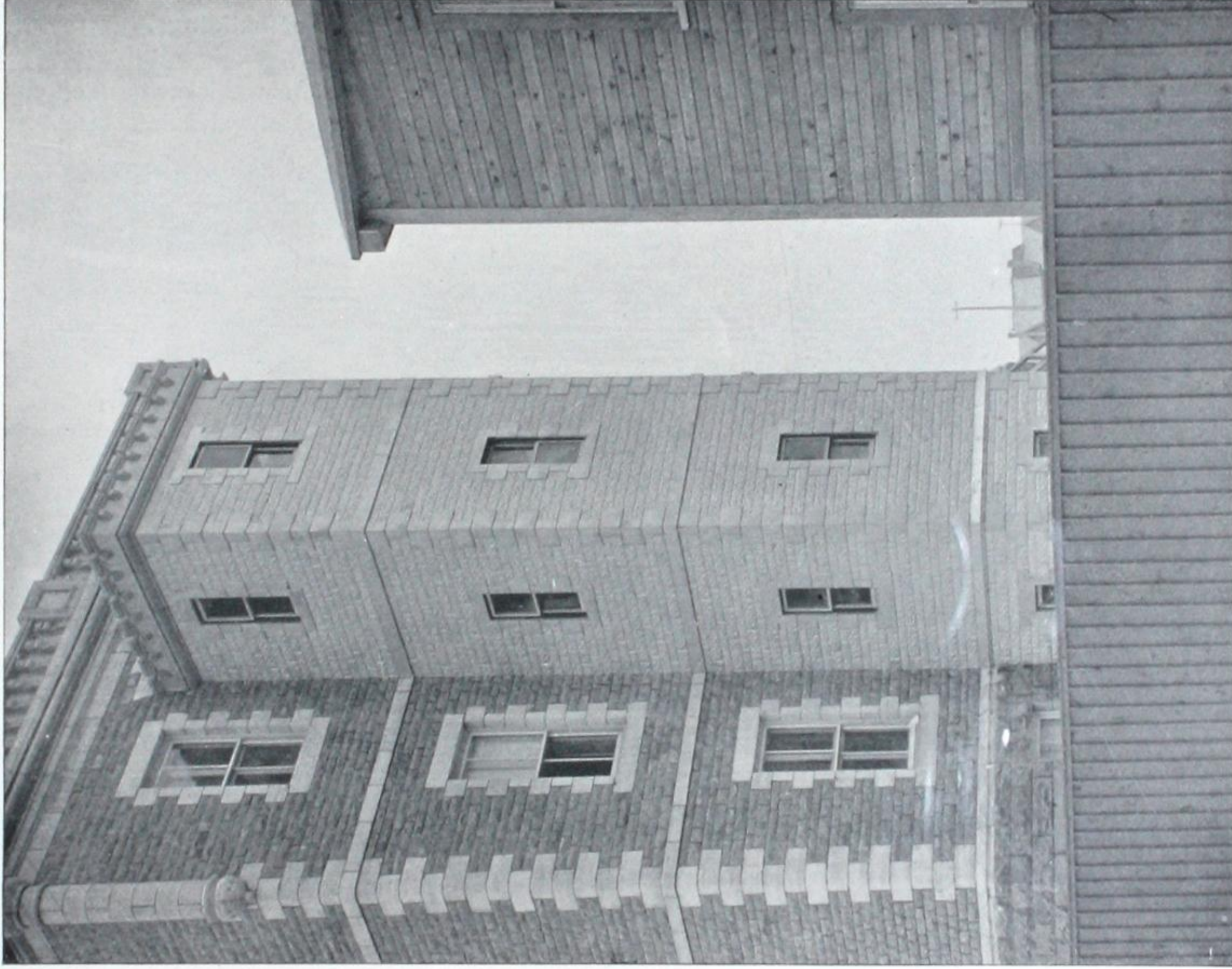

Fig. 59.

The Juniorate, Theodore St., Ottawa.

The main part of this building is of solid stone. The entire stair shaft projecting out is covered with "Our Special" Rock-faced Steel Siding, in three different sized courses, to match the solid stone. This is an exact reproduction from a photo, and, as will be seen, the steel has equally as good an appearance as the solid stone.

“Four-in-One” Rock-Faced Stone.

Galvanized or Painted.

Quickly laid—Very bold in relief—Seams not noticeable—Suitable for all classes of buildings.

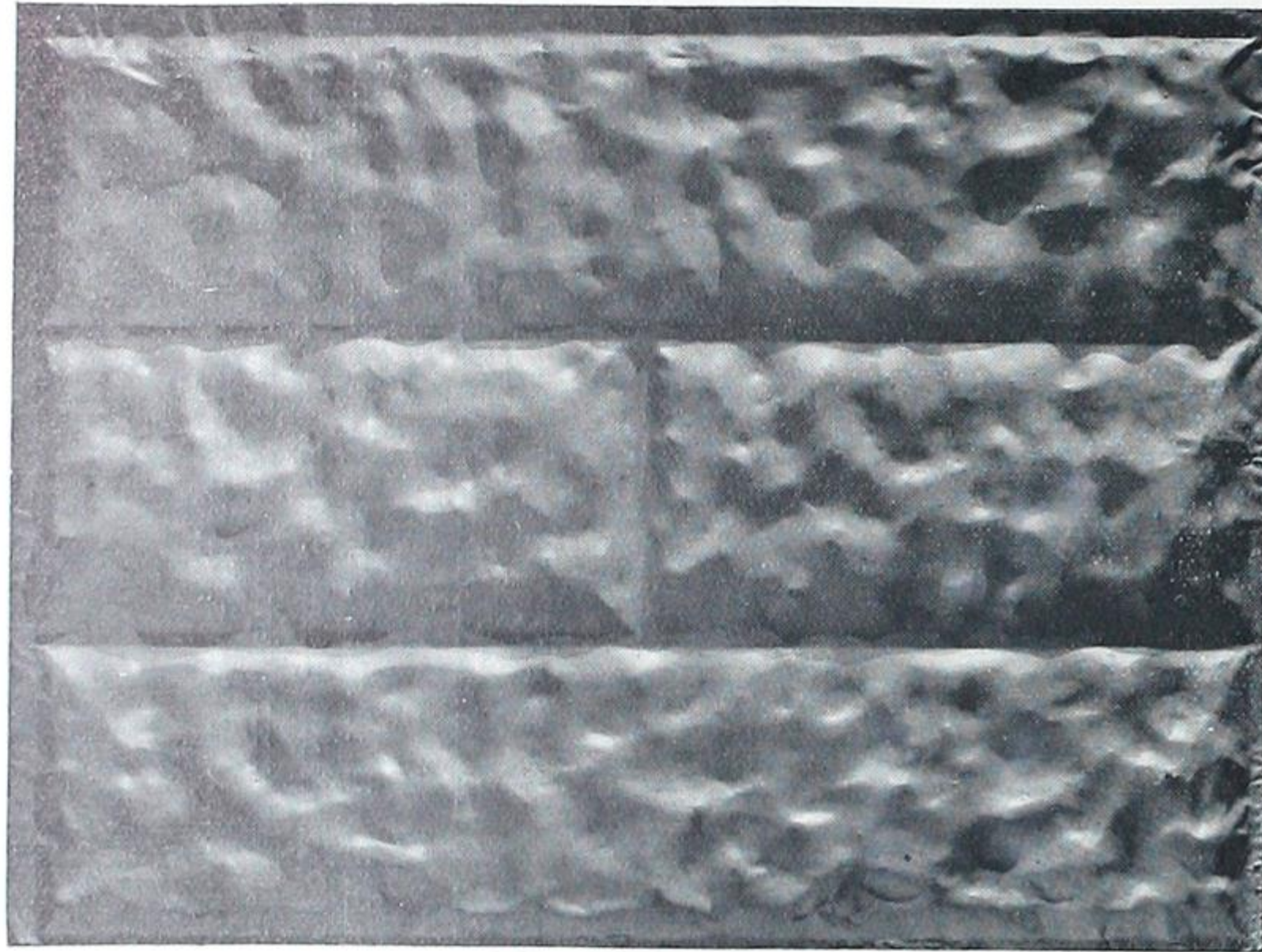

Fig. 60.

One Sheet of our “Four-in-One” Rock-Faced Stone Siding.

Covering size of sheets, $23 \times 17\frac{1}{4}$ inches each.

Thirty-seven sheets to a square (one hundred square feet).

THERE are two full stones and two half stones on each sheet, as shown in the illustration, which is an exact photographic reproduction of a sheet of the material. Each full sized stone is $23 \times 5\frac{3}{4}$ inches.

Sheets are laid from **right** to **left**, the narrow flanges overlapping the wide flanges. Start every alternate course with a half sheet, so as to break joints of the stones.

Made in three grades (different thicknesses) of painted steel, and three grades (different thicknesses) of galvanized steel.

The approximate average weights of the various grades, **exclusive of any package**, are:

No. 1, Painted	75 lbs. per square.
No. 2, Painted	66 “ “
No. 3, Painted	55 “ “
No. 1, Galvanized	88 “ “
No. 2, Galvanized	77 “ “
No. 3, Galvanized	66 “ “

Shipping weights about 10 lbs. per square additional in each case.

The sheets have a plain flange on all four sides, which overlap each other at the top and side. The overlapping flanges are the same width as those that divide the stones on each sheet, so that the joints are not noticeable, and every line of joint is crossed or broken. Thus all unsightly seams are entirely removed, imparting a character to the work and giving it every appearance of solid stone.

The painted siding is thoroughly coated on both sides with our magnetic oxide of iron paint (a rich reddish brown color), mixed only with pure linseed oil and turpentine, which is the best preservative for the metal for the first coat.

Splendid effect is obtained in painting the siding after being laid by using paint mixed the desired color, and while it is still wet blowing on fine screened lake sand with a small bellows, thereby making the sand adhere to the paint, and giving the work a finish with every appearance of genuine stone.



THE METALLIC ROOFING COMPANY OF CANADA, LIMITED, TORONTO, CANADA.

Continuous Rock-Faced Stone.

Galvanized or Painted.

Used for Window Sills, Belt Courses, etc. Made in Sheets Eight Feet Long.



Fig. 61.
Size, six inches wide.



Fig. 62.
Size, eight inches wide.



Fig. 63.
Size, ten inches wide.



Fig. 64.
Size, twelve inches wide.

One grade of galvanized steel, and one grade of painted steel. Weight from about seventy-five pounds to ninety-five pounds per square. Illustrations shown are photographic reproductions taken from the goods themselves. Design at ends of sheets is continuous, and this material is not intended to be used by itself as a siding.

Rock-Faced Steel Brick.

Galvanized or Painted.

A very careful Reproduction in Sheet Metal of the best Pressed Clay Rock-Faced Brick.

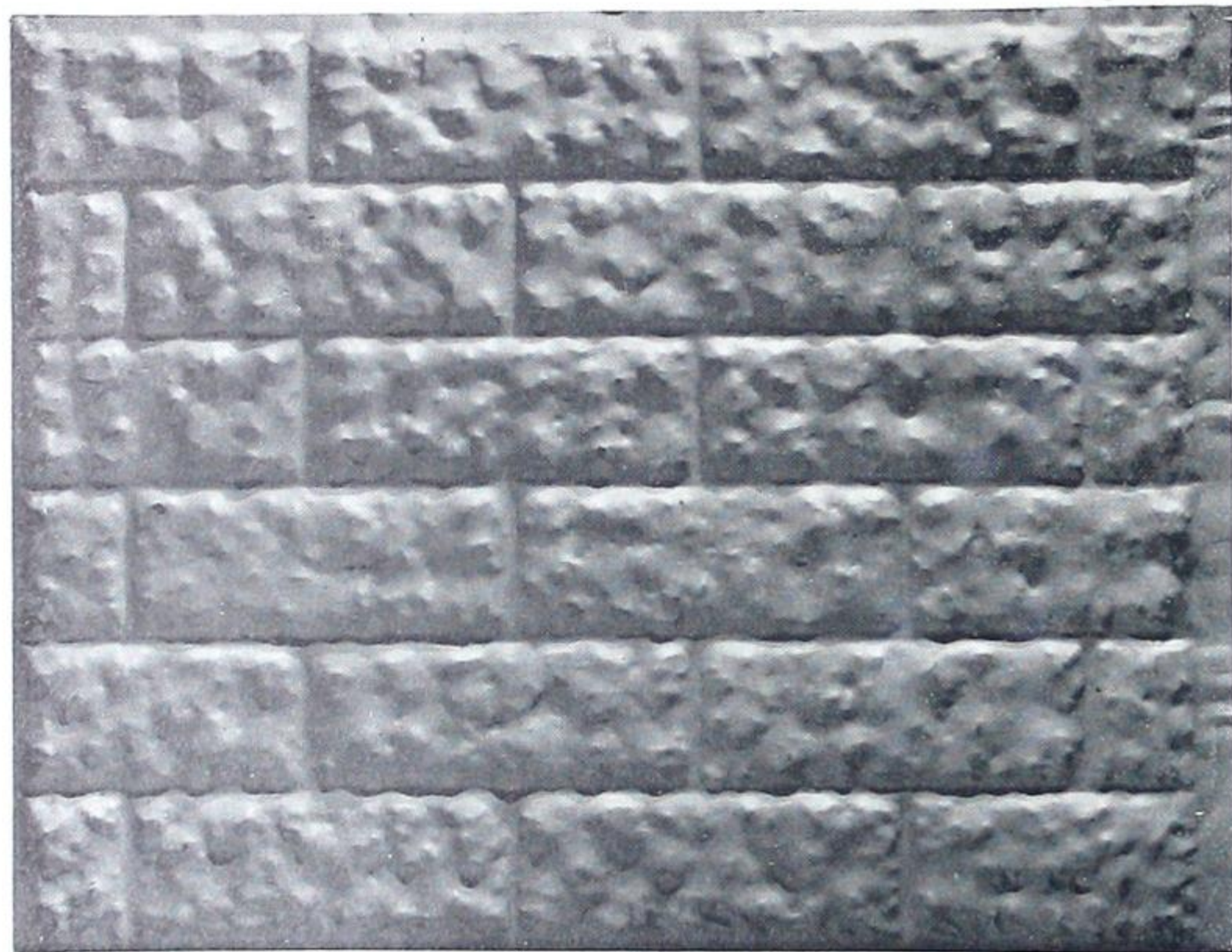

Fig. 65.

Photographic Reproduction Direct from One Sheet.

Covering size of sheets, $22\frac{1}{2} \times 17\frac{1}{2}$ inches each; thirty-seven sheets to a square (one-hundred square feet).

Size of bricks, $7\frac{1}{2} \times 3$ inches.

SHEETS are laid from **right** to **left**, the narrow flanges overlapping the wide flanges, so as to show just the same space as the distance between the bricks.

Made in three grades (different thicknesses) of painted steel, and three grades (different thicknesses) of galvanized steel.

The approximate average weights of the various grades, **exclusive of any package**, are :

No. 1, Painted	75	pounds per square.
" 2, Painted	66	" "
" 3, Painted	55	" "
" 1, Galvanized	88	" "
" 2, Galvanized	77	" "
" 3, Galvanized	66	" "

Shipping weights, about ten pounds per square additional in each case.

The sheets are constructed with plain flanges where they unite at the sides and top, which overlap, making a close, tight seam, the same size as the space between the bricks. All lines of joints are broken, and the appearance is just the same as if single bricks had been used.

The painted siding is thoroughly coated on both sides with our regular red oxide preservative, which is the best protection for the metal for the first coat. The siding may be painted to match any shade desired, after being laid.

THE METALLIC ROOFING COMPANY OF CANADA, LIMITED, TORONTO, CANADA.

Sheet Steel Pressed Brick.

Galvanized or Painted.

Suitable for Covering the Exterior Walls of all classes of Buildings. Fire-Proof, Light in Weight, Warm as Solid Brick, will not Crack nor Drop Off, and can be applied by Anyone.



Fig. 66.

Illustration Shows One Sheet of our Sheet Steel Pressed Brick.

Covering size, $22\frac{1}{2} \times 17\frac{1}{2}$ inches; thirty-seven sheets to a square.



MADE from finest of soft steel plates, either painted or galvanized, in sheets as shown in illustration, stamped up to represent pressed brick. Made in three grades (different thicknesses) of painted steel, and three grades (different thicknesses) of galvanized steel. The approximate average weights of the various grades, **exclusive of any package**, are:

No. 1, Painted	75 lbs. per square.	No. 1, Galvanized	88 lbs. per square.
No. 2, Painted	66 " "	No. 2, Galvanized	77 " "
No. 3, Painted	55 " "	No. 3, Galvanized	66 " "

Shipping weight about ten pounds per square additional in each case.

THE METALLIC ROOFING COMPANY OF CANADA, LIMITED, TORONTO, CANADA.

The sheets are formed up ready to apply to the building, being provided with a vertical lock, by means of which they are joined together at the sides, while at the cross seams the sheets overlap each other, so as to make an invisible joint.

Sheet Steel Pressed Brick is applied direct to the sheeting, being nailed with wire nails in the flange of the side lock and also where the sheets overlap.

The galvanized siding is not painted before shipping, as the coating of zinc preserves the metal, but the painted siding is all thoroughly coated on both sides with our standard quality of elastic magnetic oxide of iron paint, mixed only with pure linseed oil and turpentine. This coating is the best preservative for the metal, for the first coat, but after the siding is laid, it may be painted a flat brick color of any desired shade, to represent red, buff, or white brick, and then striped with either white or black lines where the grooves are stamped.

Sheet Steel Pressed Brick.

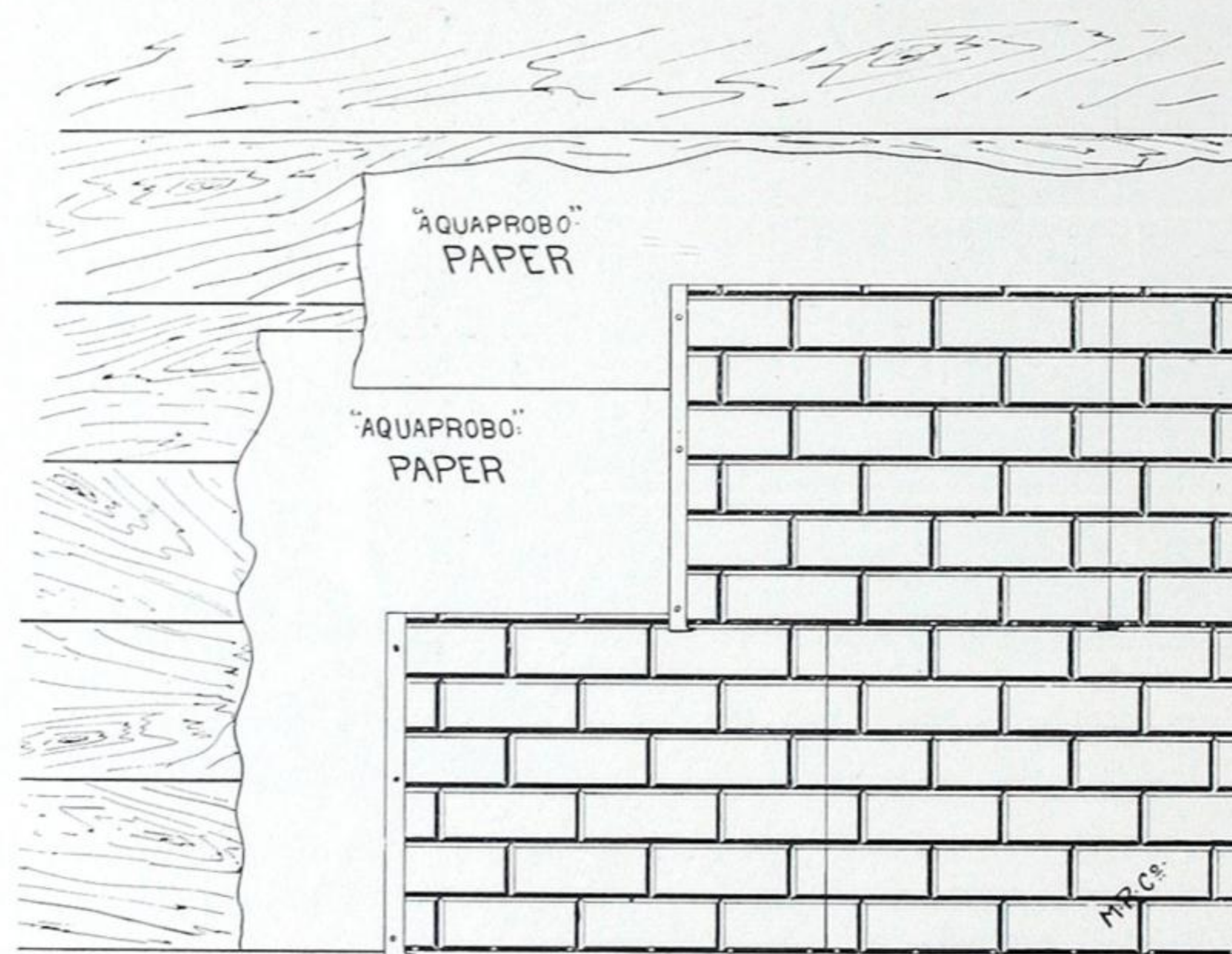

Fig. 67.

Commencement of first two Courses, showing where to nail.

By starting every other row with a third of a sheet, the pattern is made to match and every vertical joint is broken.

“Manitoba” Siding.

Especially adapted for Covering the Sides of Large Buildings, such as Elevators, Mills, Storehouses, etc., etc., where there is liable to be Considerable Settling of the Building.

MADE in three grades of painted steel plate. The difference is in the thickness of the metal only. Can also be made from galvanized steel, when desired, in same weight of plate as is used in Sheet Steel Pressed Brick.

No. 1,	weighing on the average	75	lbs. per square.
No. 2,	“ “ “	66	“ “
No. 3,	“ “ “	55	“ “

Weights given above are the **approximate average** of the various grades of painted “Manitoba” Siding, **exclusive of the packages**. Shipping weights, about ten pounds per square additional in each case.

The painted siding is thoroughly coated on both sides with our standard quality of magnetic oxide of iron paint, mixed only with pure linseed oil and turpentine.

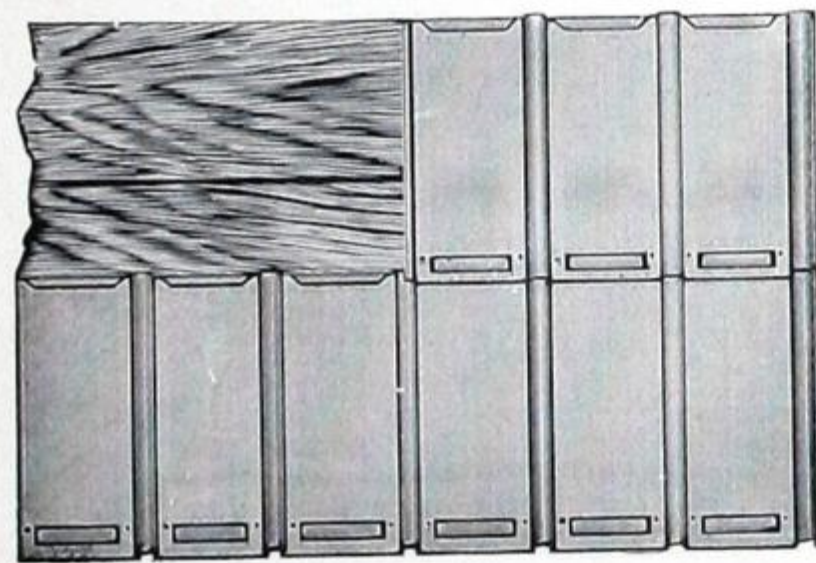

Fig. 69.

Commencement of first two Courses, showing three sheets put together, and also where to nail.

This siding is made with the same lock at the sides of the sheet as is used on our Sheet Steel Pressed Brick.

The size of the sheets makes this a very convenient siding for a workman to handle on a swinging scaffold, such as is necessarily used on grain elevators or similar buildings.

The nails go in the flange of the side lock, and also through the bottom of the overlapping course, but about an inch higher up than the top part of the under row. As the nails do not go through the under sheet, it has a chance to slip up, thus allowing the building to settle one inch in every seventeen inches, before the fastenings can possibly be disturbed or the sheet get buckled.



Fig. 68.

One Sheet of our “Manitoba” Siding.

Sheets cover, when laid $22\frac{1}{2} \times 17\frac{1}{2}$ inches; thirty-seven sheets to a square.

Steel Clapboards.

Galvanized or Painted.

For Covering the Exterior Walls of all descriptions of Buildings, and more particularly for Houses.

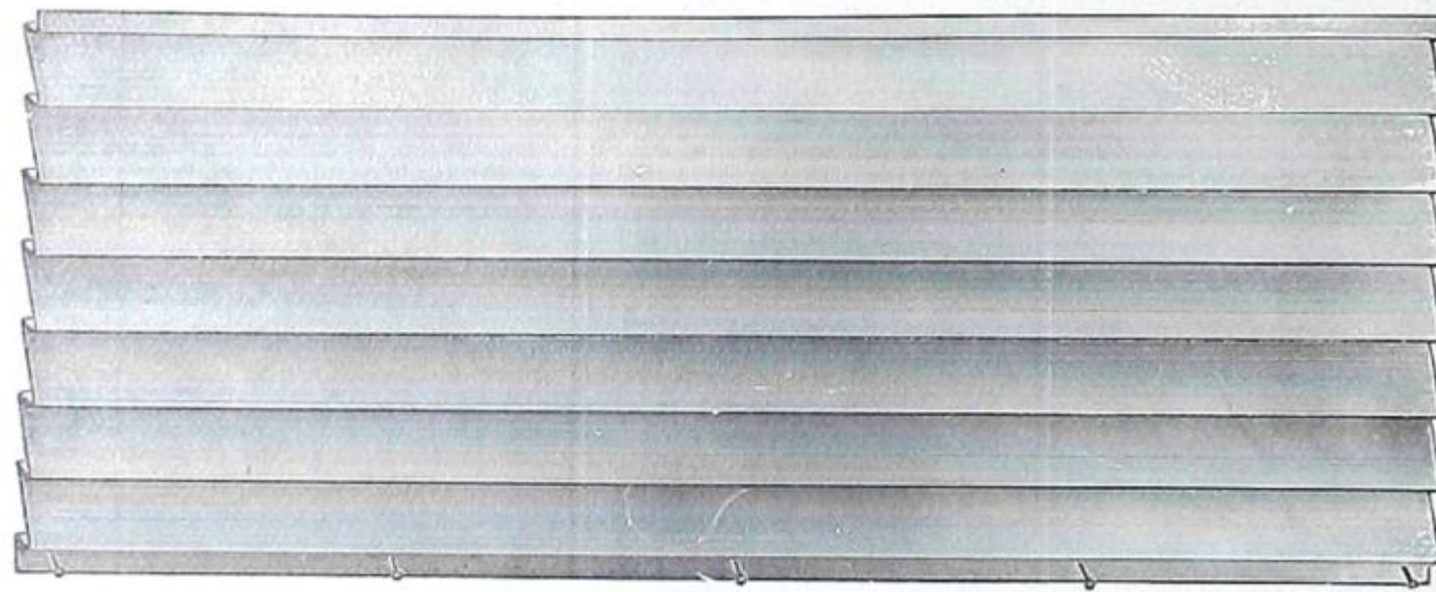

Fig. 70.

One Sheet of our Steel Clapboard Siding.

This form of siding is best laid **commencing at the top and working downwards**, by raising the lower edge of the upper sheet out sufficiently to allow the upper edge of the lower sheet to hook into place, as shown in Fig. 71.

This prevents the sheets sliding down when nailing, as they are liable to do when laying from the bottom up, and ensures a perfect and even joint.

The sheets are nailed in the flange for that purpose every six inches apart, if on sheeting. The ends of the up the joint same as shown in Fig. 71. The nails should

Painted Clapboards are all thoroughly coated on which is the best for the first coat, but they may be

SUPPLIED galvanized or painted, twenty-six or twenty-eight gauge. Standard size of **galvanized** sheets, 96 x 26 $\frac{1}{4}$ inches covering width. Standard sizes of **painted** sheets, six or eight feet long by 26 $\frac{1}{4}$ inches covering width. Any size of sheet up to ten feet in length can be supplied to order.

Weight from about eighty to one hundred pounds per square, depending on the gauge. Six sheets eight feet long to a square, or eight sheets six feet long to a square. Sheets are all accurately squared and made on special machinery to the shape of wooden clapboards, as shown in Fig. 70; seven boards to the sheet, each 3 $\frac{3}{4}$ -inch face, with half-inch butt. They are best laid over rough sheeting, but may be applied direct to the studding, placed about twelve-inch centres.



Fig. 71.

at the bottom of each sheet, as shown in Fig. 71, about sheets are overlapped from one to two inches, and nailed be driven home with a nail set.

both sides with our regular magnetic oxide of iron paint, painted any shade desired after being laid.



"Climax" Ridge Cap.

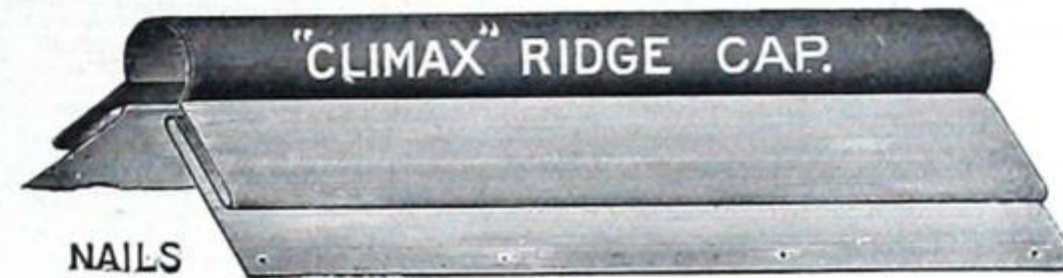

Fig. 72.

Made of galvanized iron **only**, in lengths of eight feet. This form of Ridge Cap is applied **before** the shingles, which fit into the bend in the cap, so that all nail heads are covered.

Roll Top Ridge or Hip Cap.



Fig. 73.

Either Galvanized or Painted.

The above cut shows our Roll Top Cap, which is supplied complete with **wood roll**, and is used for finishing at **ridges** and **hips**, being applied **after** the shingles are laid.

We also supply this same shape of Cap, without the wood roll, in fifteen or eighteen-inch girth, for use with V Crimped and Corrugated Roofing.

Ornamental Galvanized Iron Ridgings.

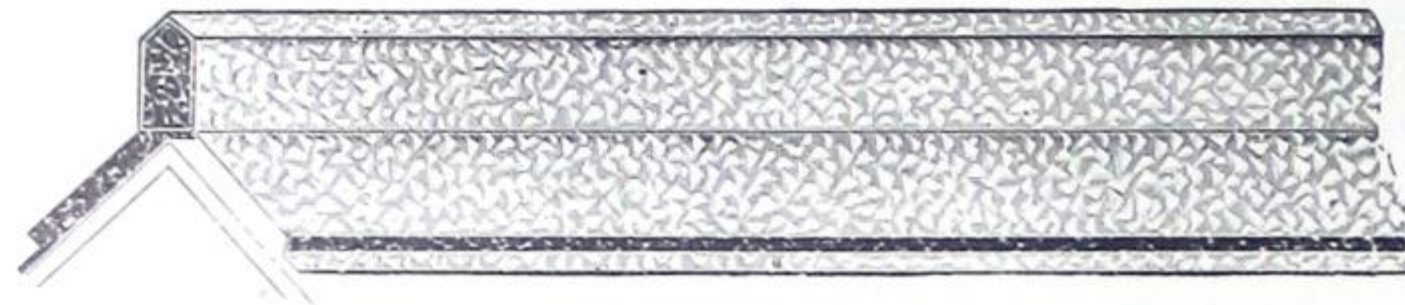

Fig. 74.

Made in Three Sizes.

Girth, 12 inches.	Height, $4\frac{3}{4}$ inches.	Apron, $2\frac{1}{2}$ inches.
“ 15 “	“ 6 “	“ $3\frac{1}{2}$ “
“ 20 “	“ 8 “	“ $4\frac{1}{2}$ “

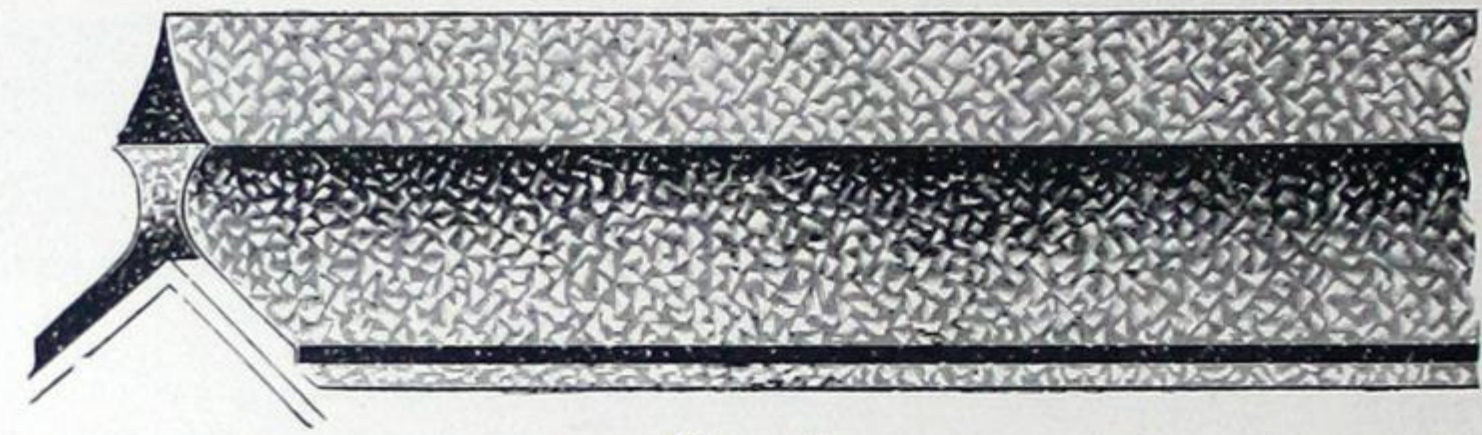

Fig. 76.

Made in Three Sizes.

Girth, 15 inches.	Height, $6\frac{1}{4}$ inches.	Apron, 3 inches
“ 20 “	“ 8 “	“ 4 “
“ 24 “	“ 10 “	“ $4\frac{1}{2}$ “

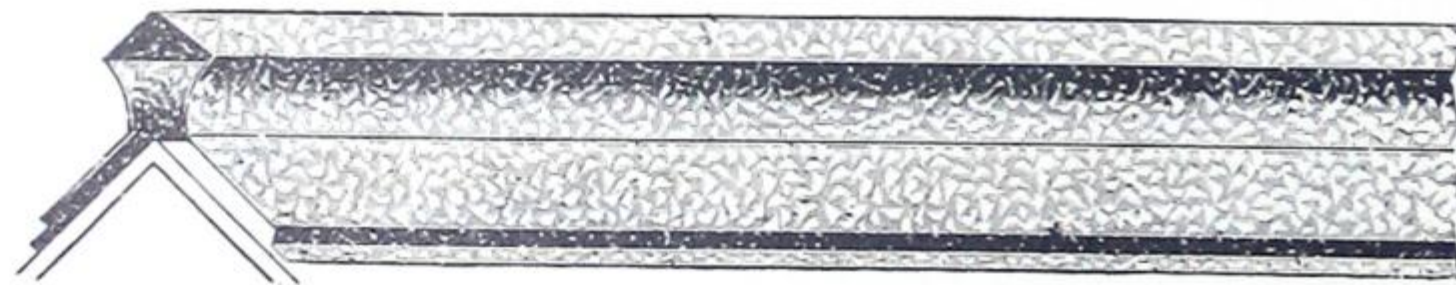

Fig. 75.

Made in Three Sizes.

Girth, 12 inches.	Height, $4\frac{1}{2}$ inches.	Apron, $2\frac{1}{2}$ inches.
“ 15 “	“ 6 “	“ 3 “
“ 20 “	“ 8 “	“ 4 “

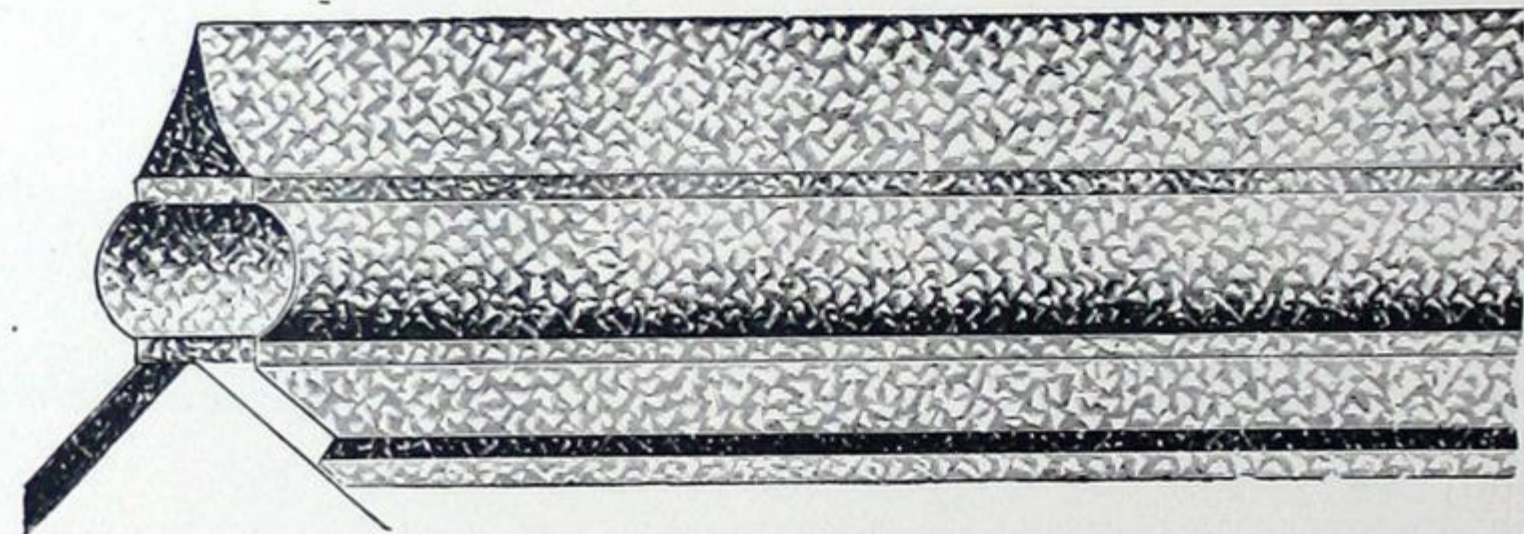

Fig. 77.

Made in Three Sizes.

Girth, 20 inches.	Height, 8 inches.	Apron, $4\frac{1}{2}$ inches.
“ 24 “	“ $9\frac{1}{2}$ “	“ 5 “
“ 30 “	“ 12 “	“ $6\frac{1}{2}$ “

Galvanized Iron Crestings.

When Ordering State Pitch of Roof.

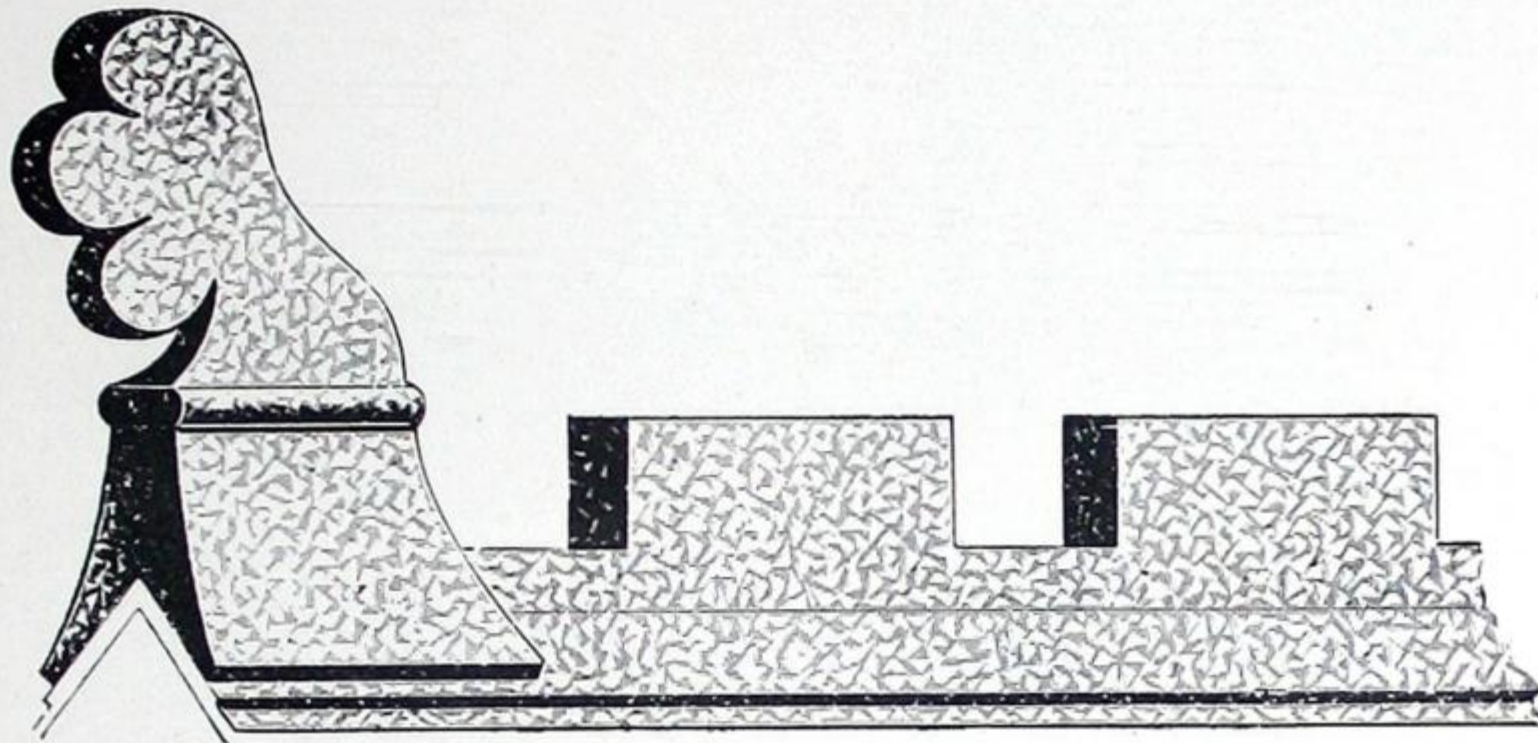

Fig. 78.

Cresting—Height, 11 inches; width of Apron, 6 inches.
Finial—Height, 22 inches.

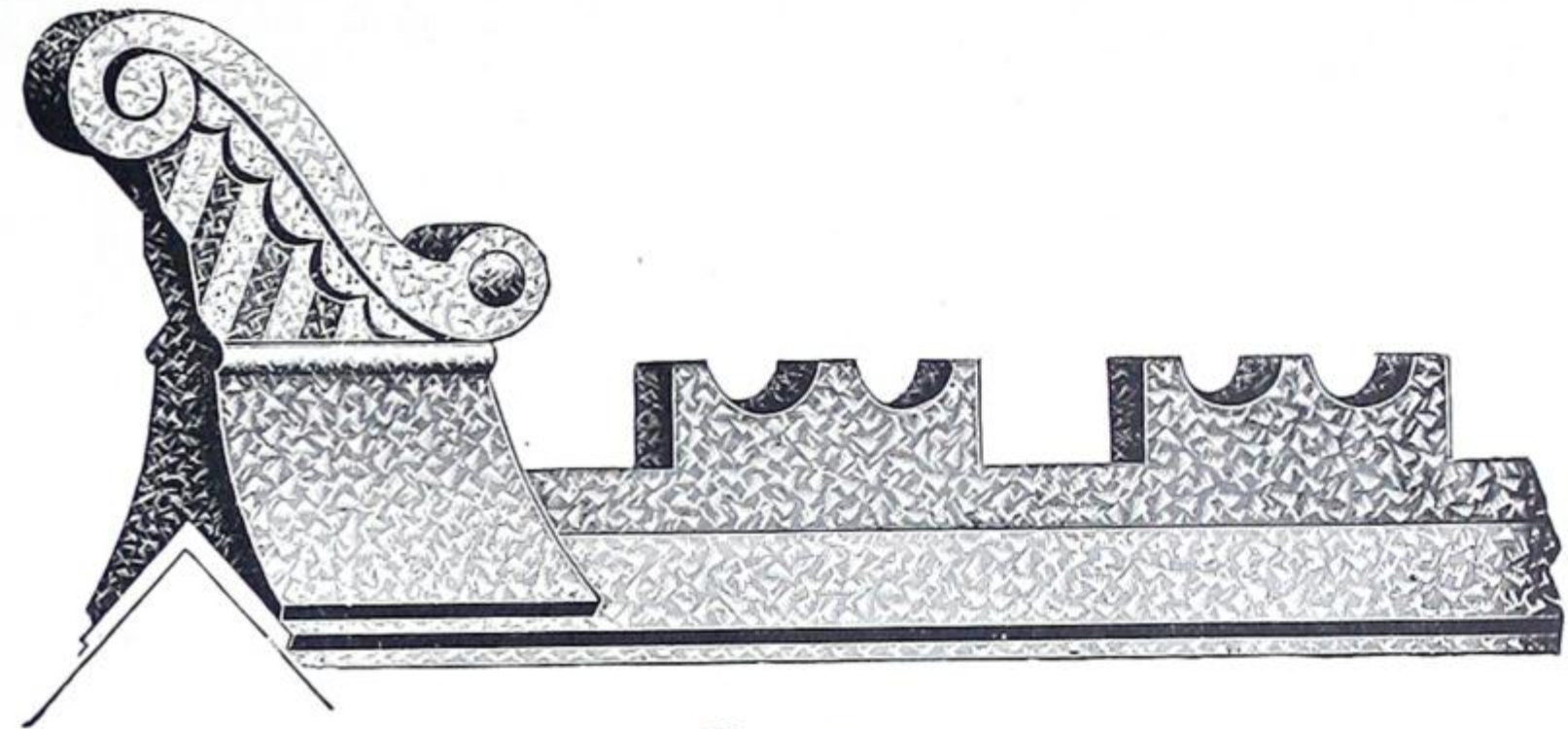

Fig. 79.

Cresting—Height, 11 inches; width of Apron, 6 inches
Finial—Height, 22 inches.

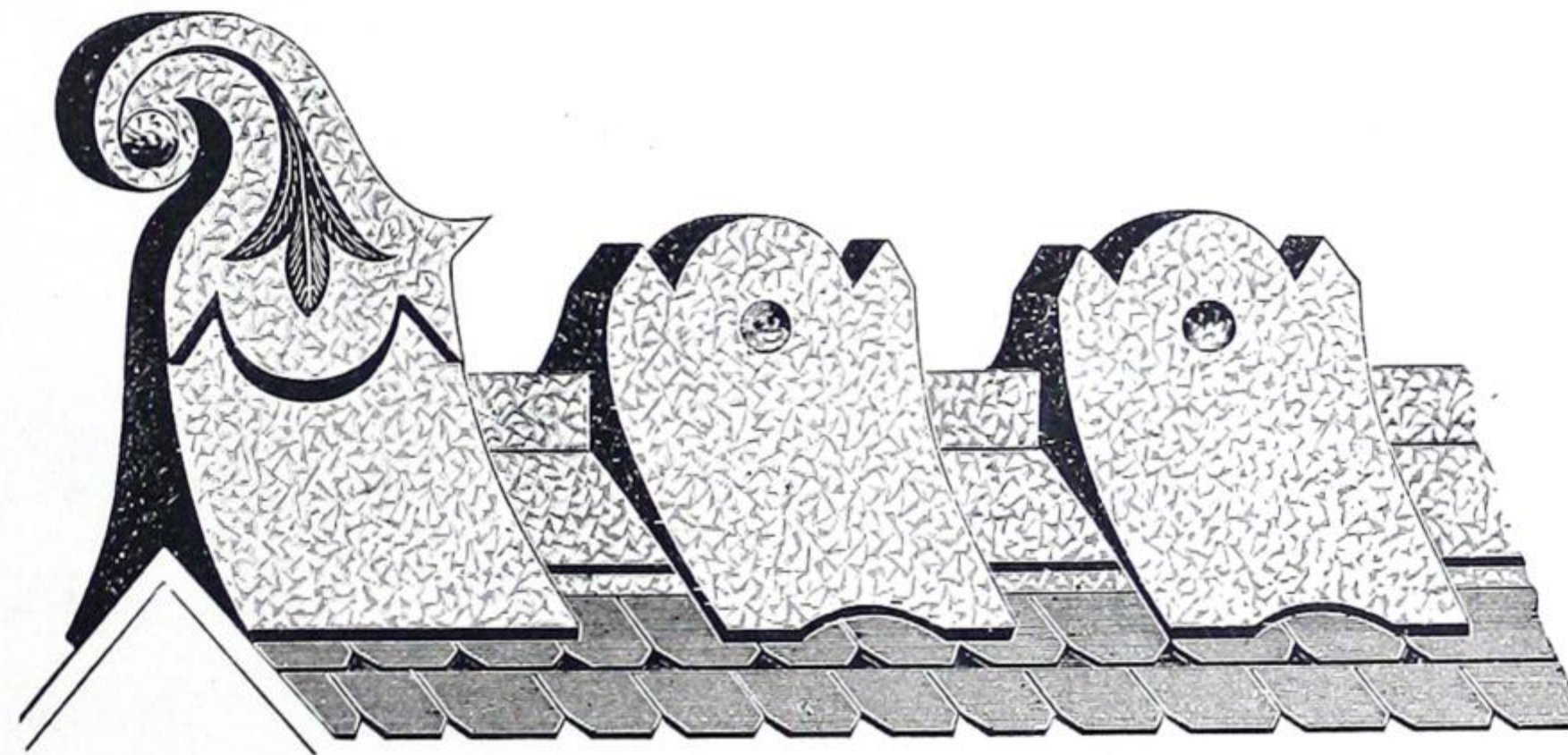

Fig. 80.

Cresting—Height, 12 inches; width of Apron, 6 inches.
Finial—Height, 20 inches.

Clapboard Corner Cap.

Made from Galvanized Iron in Lengths of Eight Feet.



Fig. 81.

Cap for use at **outside corners** with Clapboards, Corrugated or Beaded Siding.

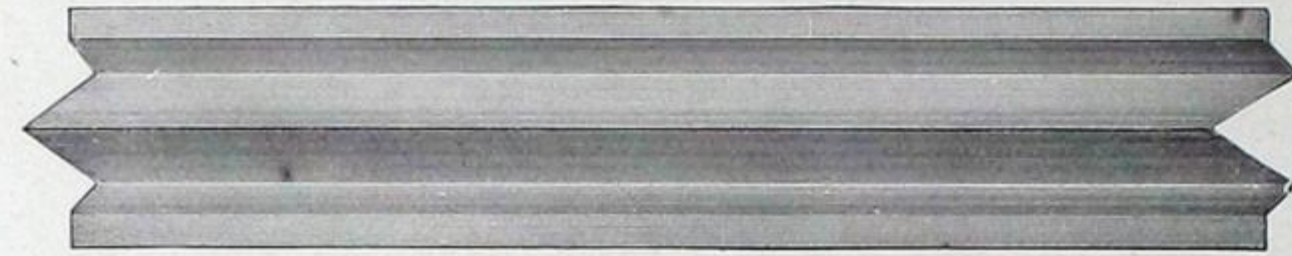

Fig. 82.

Cap for use at **inside corners**. Both these caps are put on **before** the siding, which overlaps the plain flange and butts up against the projecting shoulder on the cap.

“Imperial” Ridge or Corner Cap.

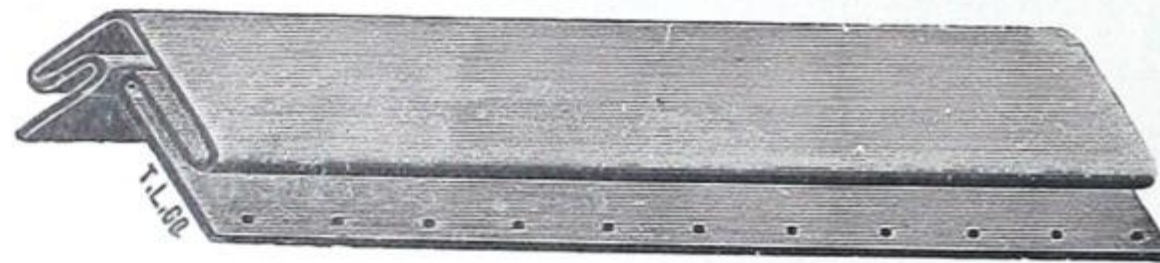

Fig. 83.

Made of galvanized iron only, in lengths of eight feet. This form of cap is applied **before** the shingle or siding plates, which fit into the bend in the cap, so that all nail heads are covered. Is also made reverse for inside corners.

V Corner Cap.



Fig. 84.

Made of painted steel, in lengths of two feet. This cap is applied **after** the siding is on.

Rock-Faced Corner Stone.
Galvanized or Painted.

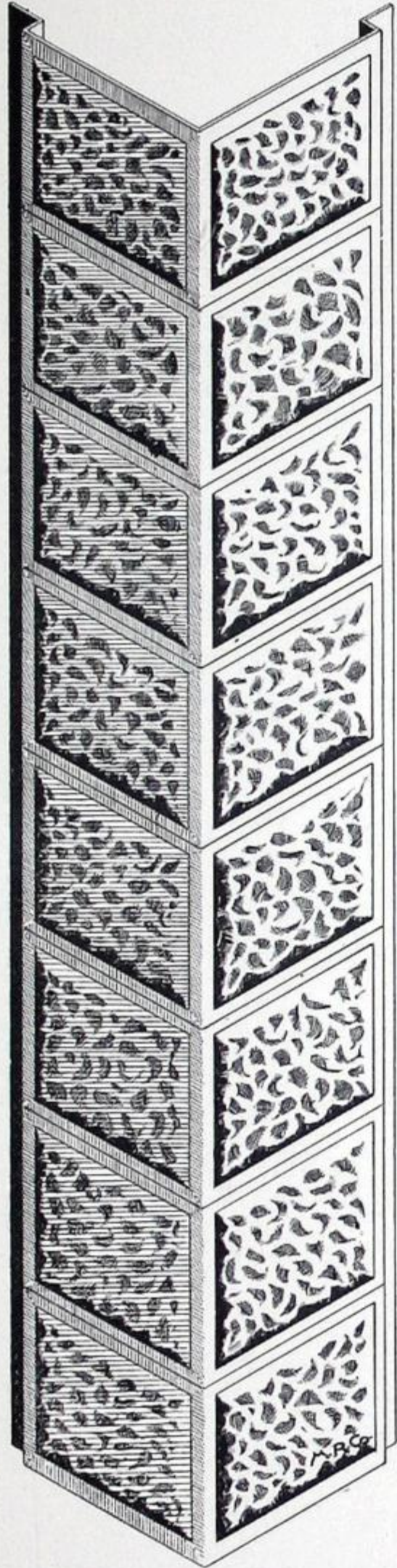

Fig. 85—Made in lengths of 8 feet. Covering face, 13 x 13 inches. For use with Rock-Faced Siding.

Rock-Faced Brick Corner Cap.
Galvanized or Painted.

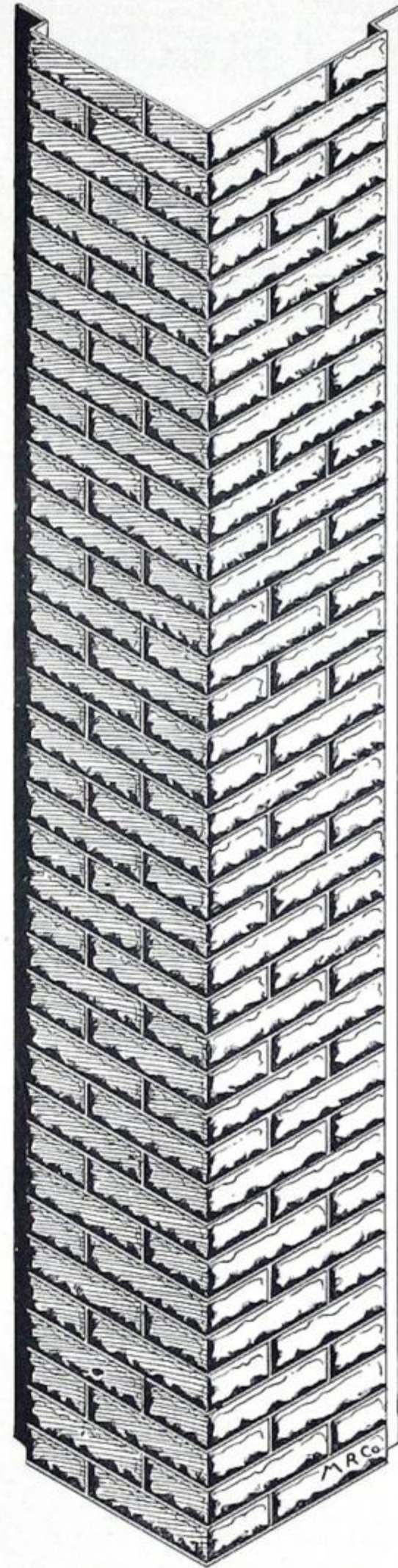

Fig. 86—Made in lengths of 8 feet. Covering face 13 x 13 inches. For use with Rock-Faced Brick Siding.

Plain Brick Corner Cap.
Galvanized or Painted.

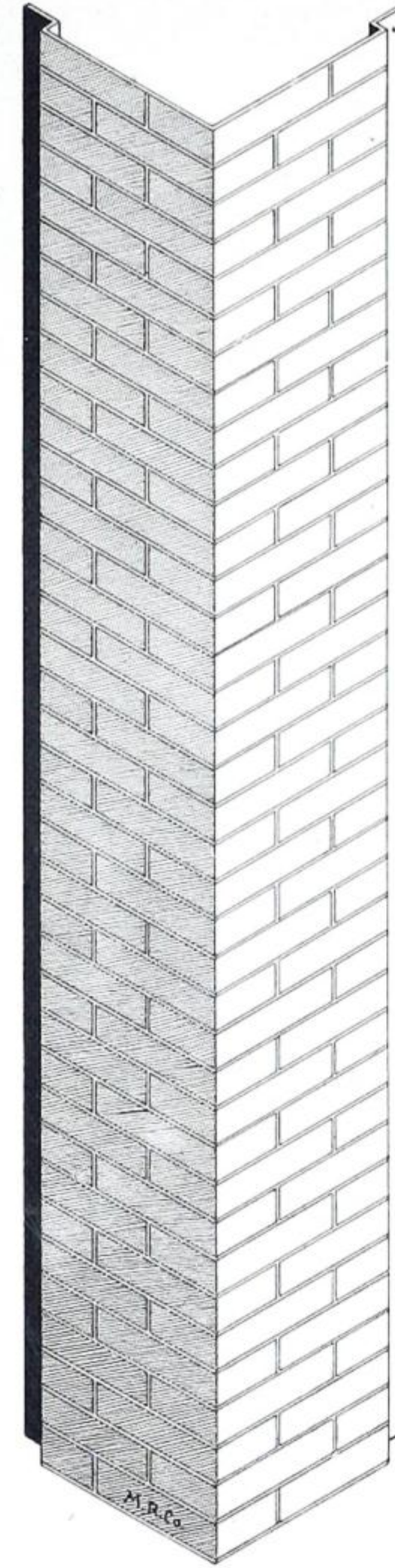

Fig. 87—Made in lengths of 8 feet. Covering face, 13 x 13 inches. For use with Sheet-Steel Pressed Brick.

Rock-Faced Quoin Stones.
Galvanized Only.

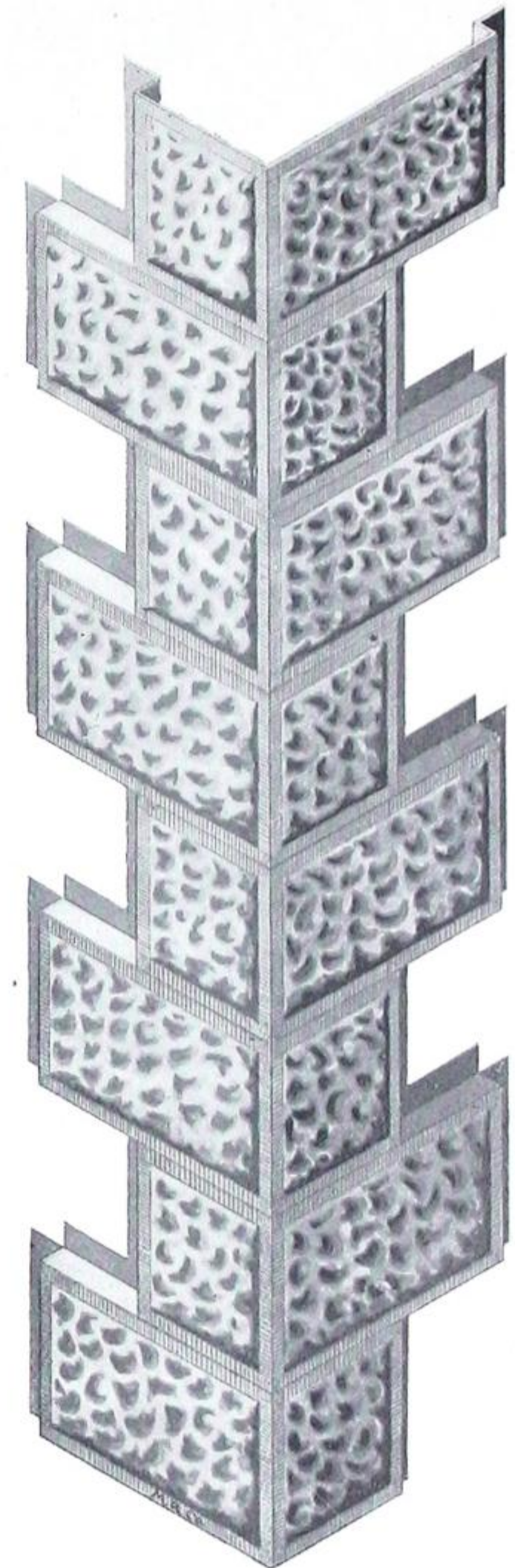

Fig. 88—Can be made either with or without Chisel-draft, with stones any size desired. In ordering, send sketch showing necessary dimensions.

Rock-Faced Pilasters. Galvanized Only.

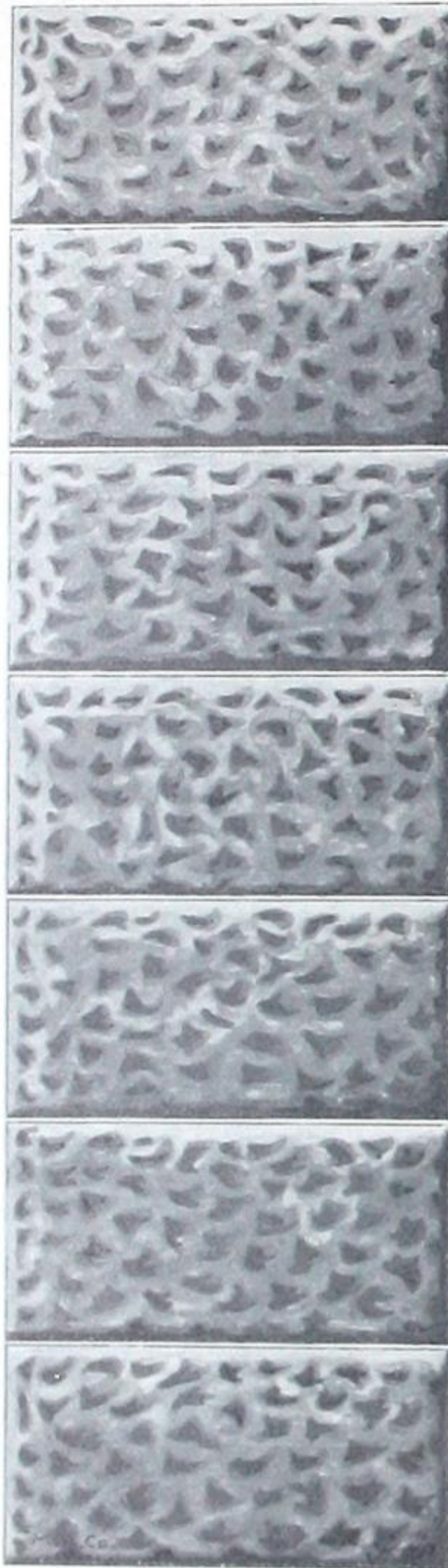

Fig. 89—Can be made either with or without Chisel-draft, with face and projection any size required. In ordering, send sketch showing necessary dimensions.

THE METALLIC ROOFING COMPANY OF CANADA, LIMITED, TORONTO, CANADA.

“Special” Valley.

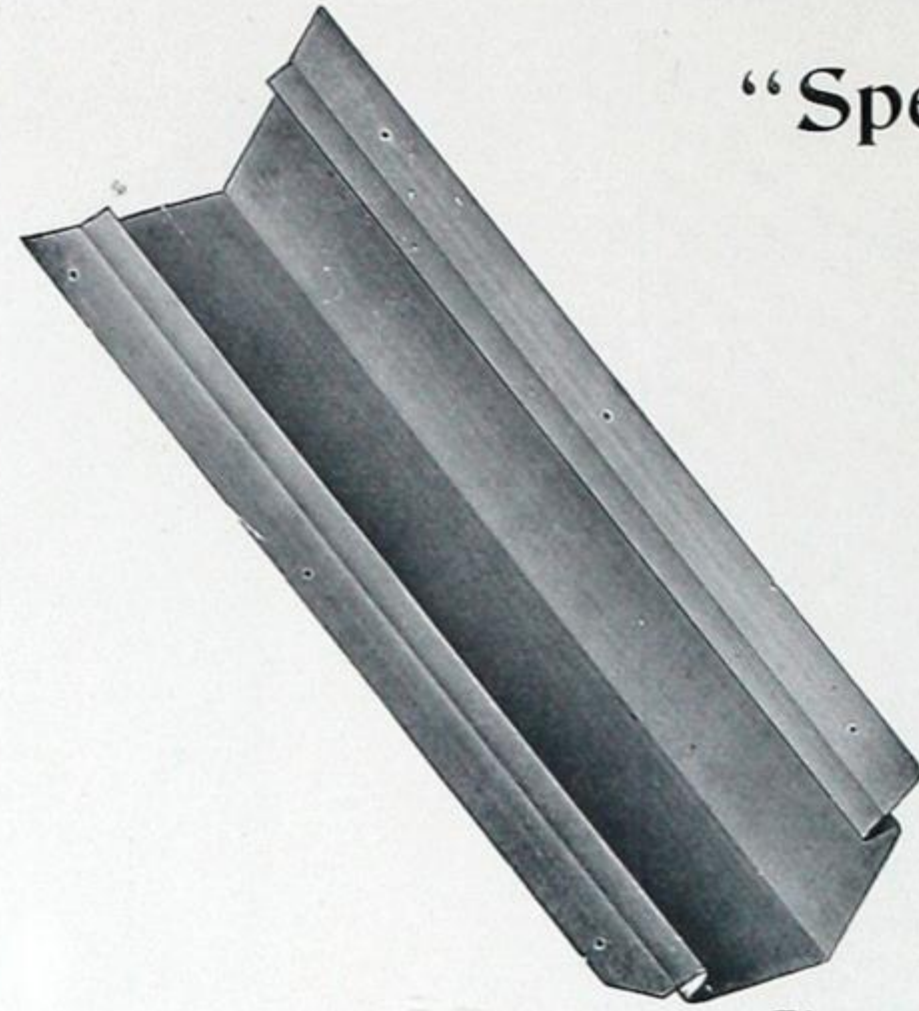

Fig. 90.

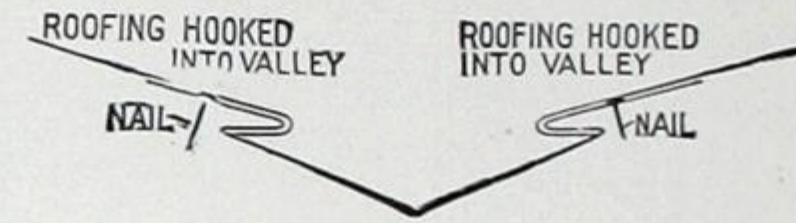

Fig. 91.

THE above cuts represent our “Special” Valley, which is applied before the roofing. Made from galvanized iron in lengths of eight feet, in fifteen, twenty, twenty-four or thirty-inch girth. Fig. 91 shows in cross section the method of uniting the shingles with the valley, by forming a hook on the shingles, and locking into the valley, so as to cover all nail heads, and making leakage an impossibility.

Fifteen-inch valley is always sent unless otherwise specially mentioned in ordering.

“Double Gutter” Valley.

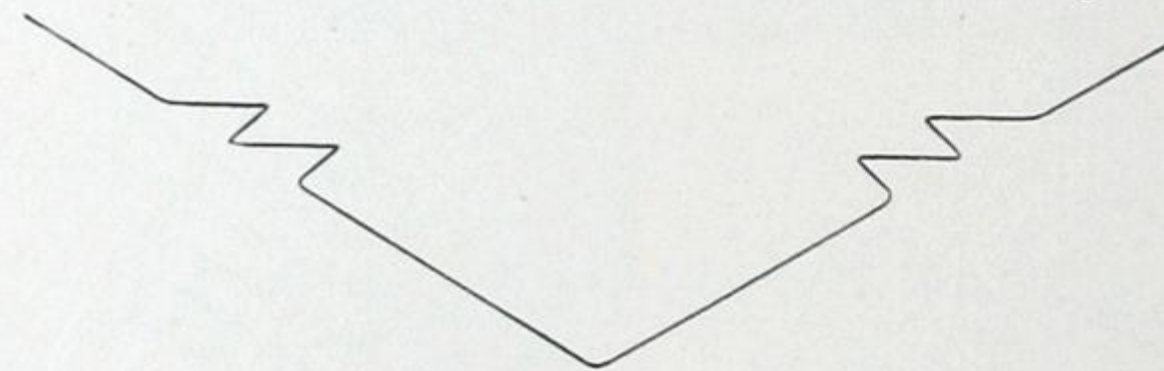

Fig. 92.

Shows in cross section our “Double Gutter Valley” for use with Corrugated or V Crimped Roofing. Made from galvanized iron, in lengths of eight feet, twenty-four or thirty-inch girth.

THE METALLIC ROOFING COMPANY OF CANADA, LIMITED, TORONTO, CANADA.

CORRUGATED IRON.

For Roofing, Siding, Ceiling and Arches.

Galvanized or Painted.



NY gauge from No. 18 to 28. Weight, depending on gauge, from about 80 to 250 pounds to the square. Sizes mentioned in catalogue are the standard sizes of sheets, and are what are generally used, but we can furnish **to order** corrugated sheets made from any brand of iron, or in any size of sheets required, up to ten feet in length.

Corrugated iron may be applied on sheeting of wood, or to iron or wood rafters and purlins without sheeting.

Our Galvanized Corrugated Iron is made from bright, smooth, cold-rolled, evenly-coated galvanized sheets of the best quality made for working-up purposes. Lower priced brands of galvanized iron, such as are ordinarily used for corrugating purposes, may be obtained for considerably less money, but, while they may be called galvanized iron, they are of such a poor quality and so poorly coated that it would pay better to use painted black iron. If you are paying for galvanized iron of any kind, the quality and coating is what should be carefully considered, for the galvanized coating is what preserves the metal, and if it is badly done, or of poor quality, then it is a protection in name only.

Our Painted Corrugated Iron is made from the finest of smooth, cold-rolled steel sheets. It is corrugated first and then thoroughly coated on both sides with our standard quality of magnetic oxide of iron paint, made up specially for metal work, and mixed with pure linseed oil and turpentine. This ensures a protection to the metal that, if replenished once every four or five years, will preserve it indefinitely.

All our corrugated sheets are accurately **squared all around** before corrugating, so that they are all of a uniform size. The corrugations are all **pressed, one corrugation at a time**, on the latest and most improved powerfully constructed machinery; consequently they are all exactly alike and uniform, and the sheets all being perfectly square, there cannot possibly be any variation, enabling a perfect job to be made at both the side and end laps, without any cutting, and keeping the corrugations in line from the eave to the ridge, or from the ground to the eave as the case may be. The advantages of **pressed corrugated** sheets over those made on rolls are manifold, for by the latter method they are rushed through the rolls so rapidly that it does not give the machine time to set the corrugations, and therefore they are not uniform in depth, as some sheets are harder and will spring more than others, so that the sheets cannot come out the same on the edges, and consequently will not fit nor keep the corrugations square and in line.

THE METALLIC ROOFING COMPANY OF CANADA, LIMITED, TORONTO, CANADA.

We Manufacture Corrugated Iron in three different sizes of Corrugations.



Fig. 93

Shows full size of $2\frac{1}{2} \times \frac{5}{8}$ -inch corrugations.



Fig. 94.

Shows full size of $2 \times \frac{5}{8}$ -inch corrugations.



Fig. 95.

Shows full size of $1 \times \frac{1}{4}$ -inch corrugations.



Fig. 96.

Sheet with $2\frac{1}{2} \times \frac{5}{8}$ -inch corrugations. **Standard length** of sheets six or eight feet.

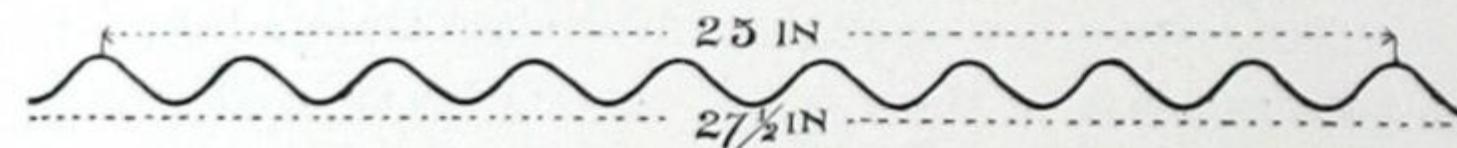

Fig. 97.

Cross section, showing **standard width** of $2\frac{1}{2} \times \frac{5}{8}$ -inch corrugated sheet. Made from stock thirty inches wide before corrugating.

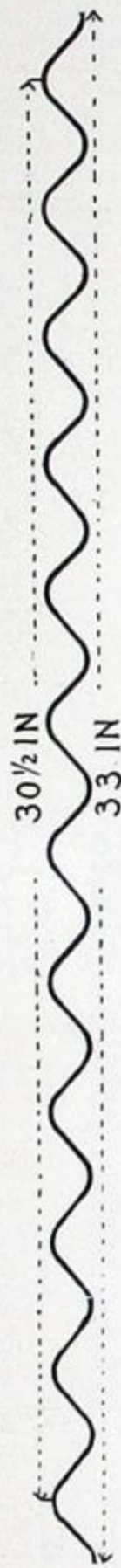

Fig. 98.

Cross Section, showing width of $2\frac{1}{2}$ x $\frac{5}{8}$ -inch corrugated sheet, when made out of stock thirty-six inches wide before corrugating.

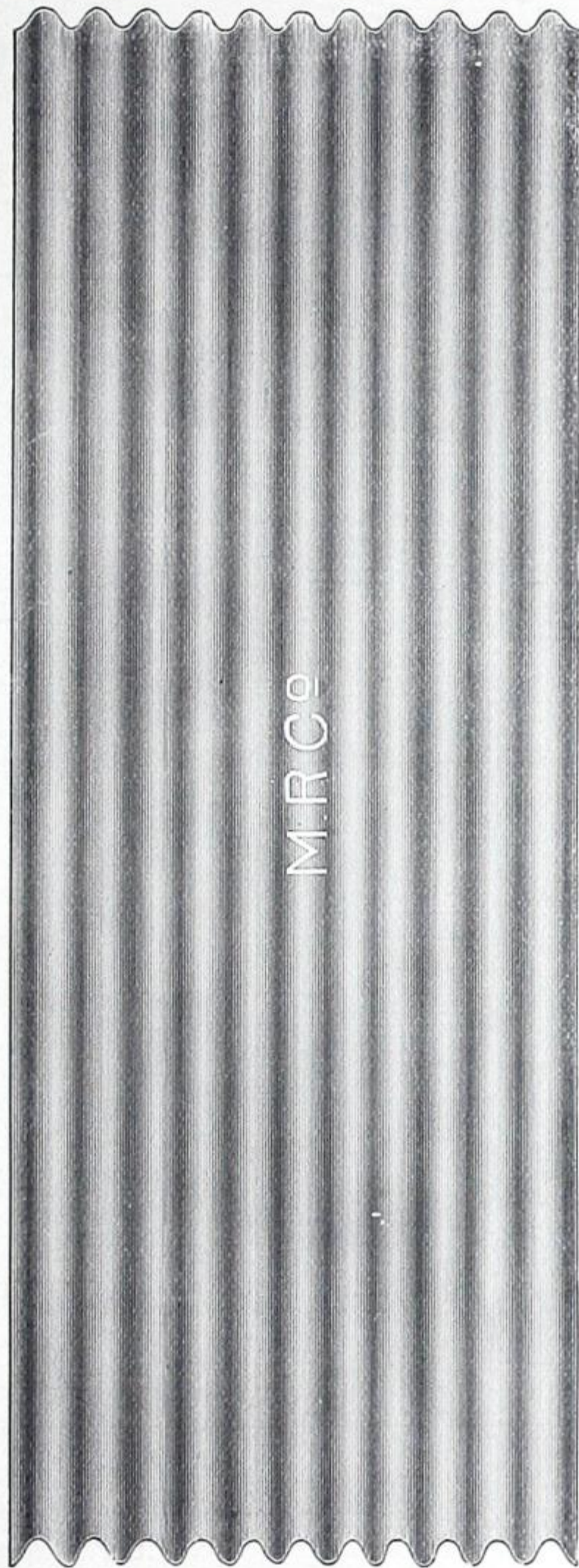

Fig. 99.

Sheet with 2 x $\frac{5}{8}$ -inch corrugations. Standard length of sheets six or eight feet.

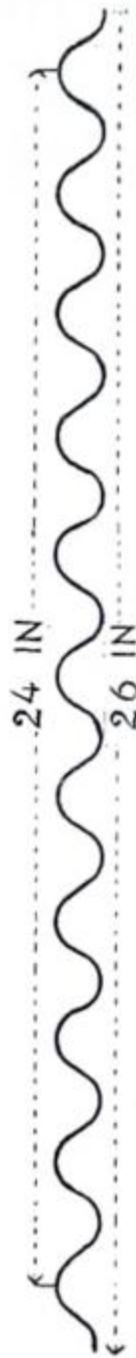

Fig. 100.

Cross section, showing standard width of 2 x $\frac{5}{8}$ -inch corrugated sheet. Made from stock thirty inches wide before corrugating.

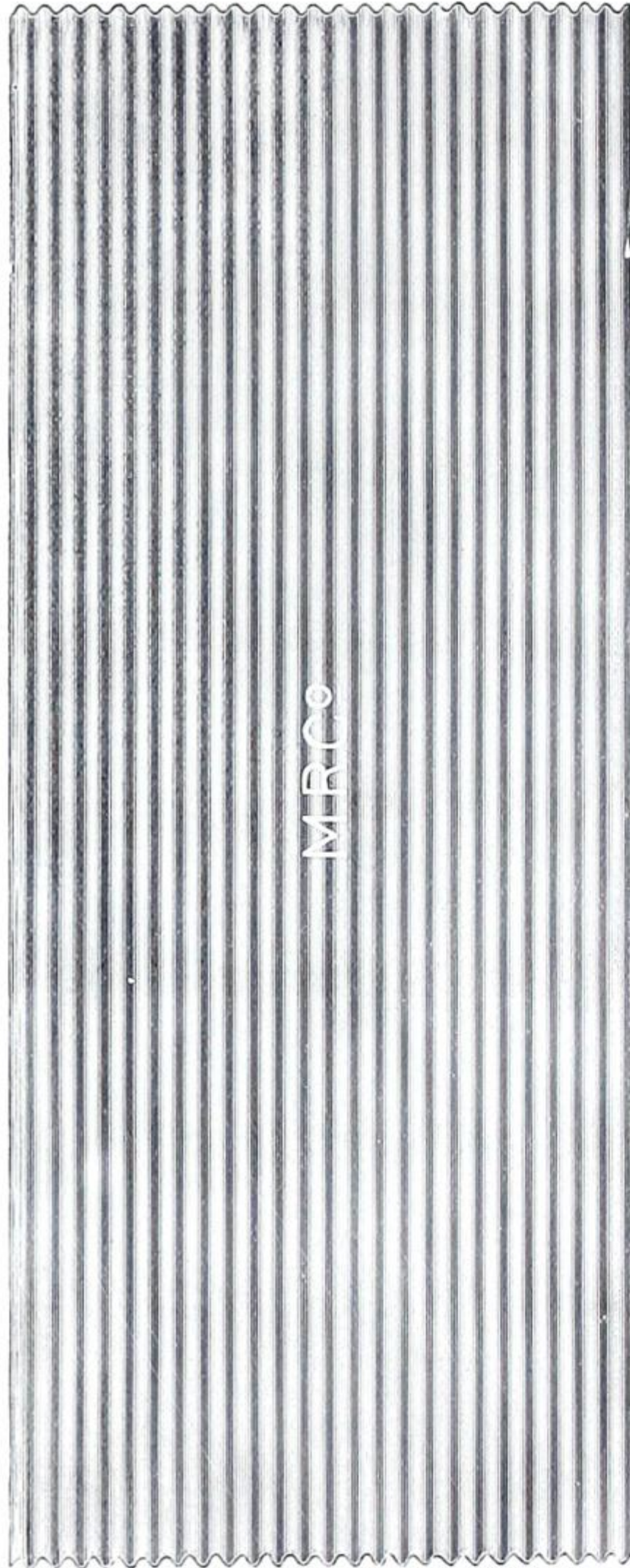

Fig. 101.

Sheet with 1 x $\frac{1}{4}$ -inch corrugations. Standard length of sheets six or eight feet.

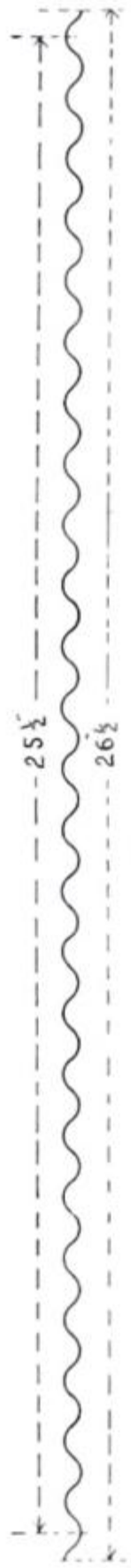

Fig. 102.

Cross section, showing standard width of 1 x $\frac{1}{4}$ -inch corrugated sheet. Made from stock thirty inches wide before corrugating.

Elevator Siding.

When so ordered sheets are punched along the bottom edge, three inches up, all ready for nailing, as shown in the illustration.

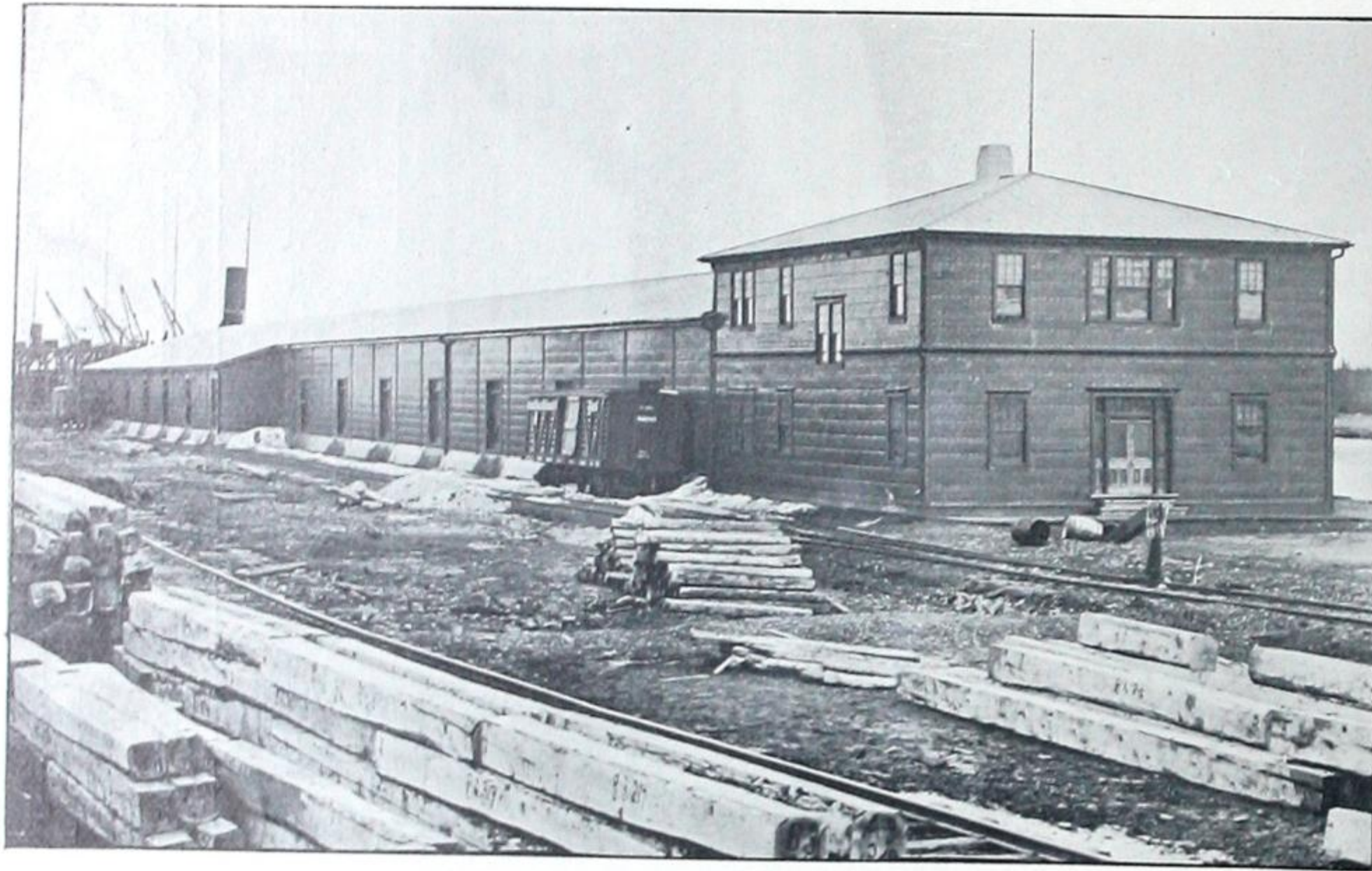

Fig. 103.

Canadian Pacific Railway Freight Sheds at Fort William, Ont.

Roof and sides covered with our goods.

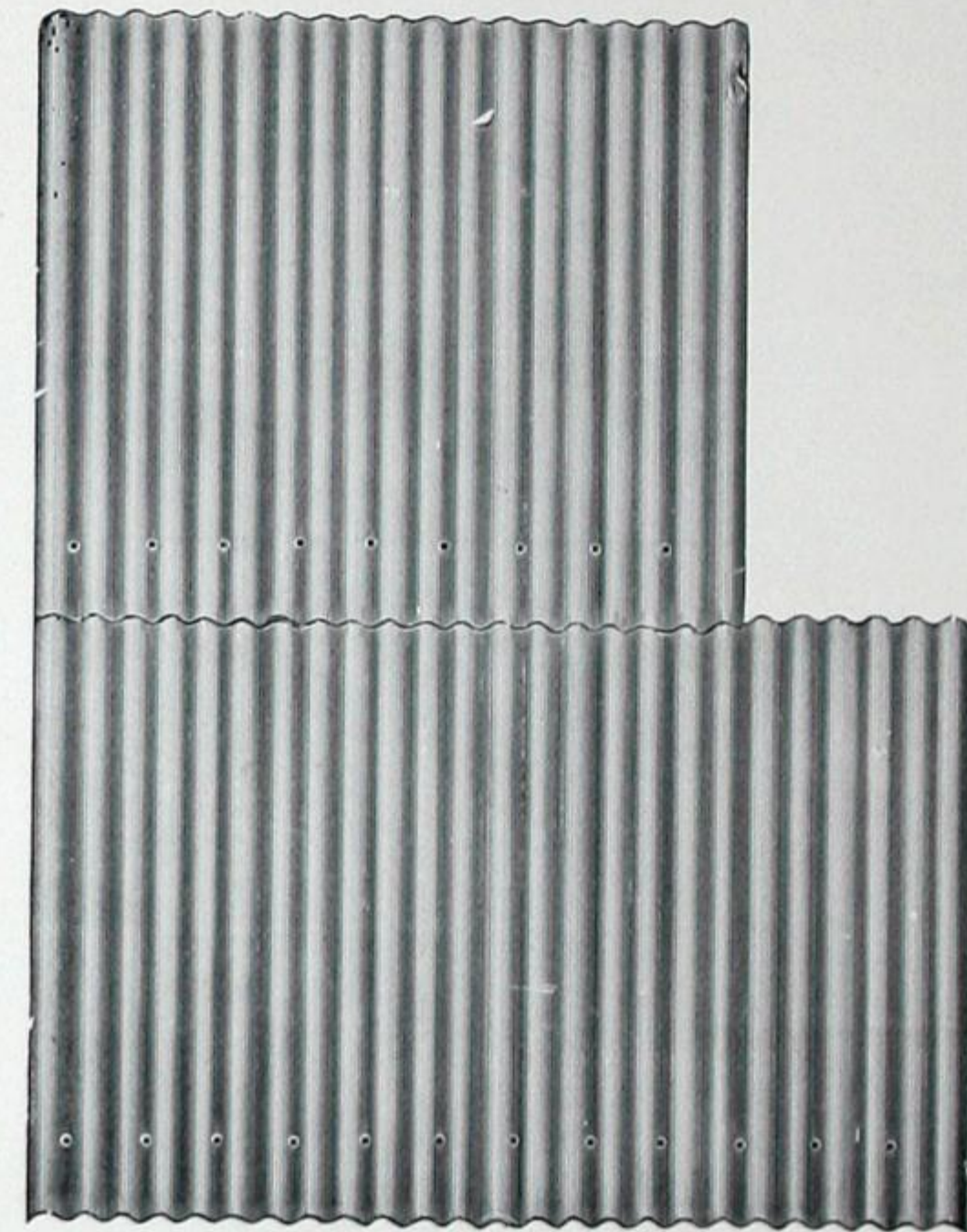

Fig. 104.

Shows corrugated iron siding for grain elevators, etc. Made in one, two or two-and-a-half-inch corrugations. Sheets two, three or four feet long, width depending on size of corrugation. (See illustrations of cross sections of sheets.)

Cross Corrugated Elevator Siding.

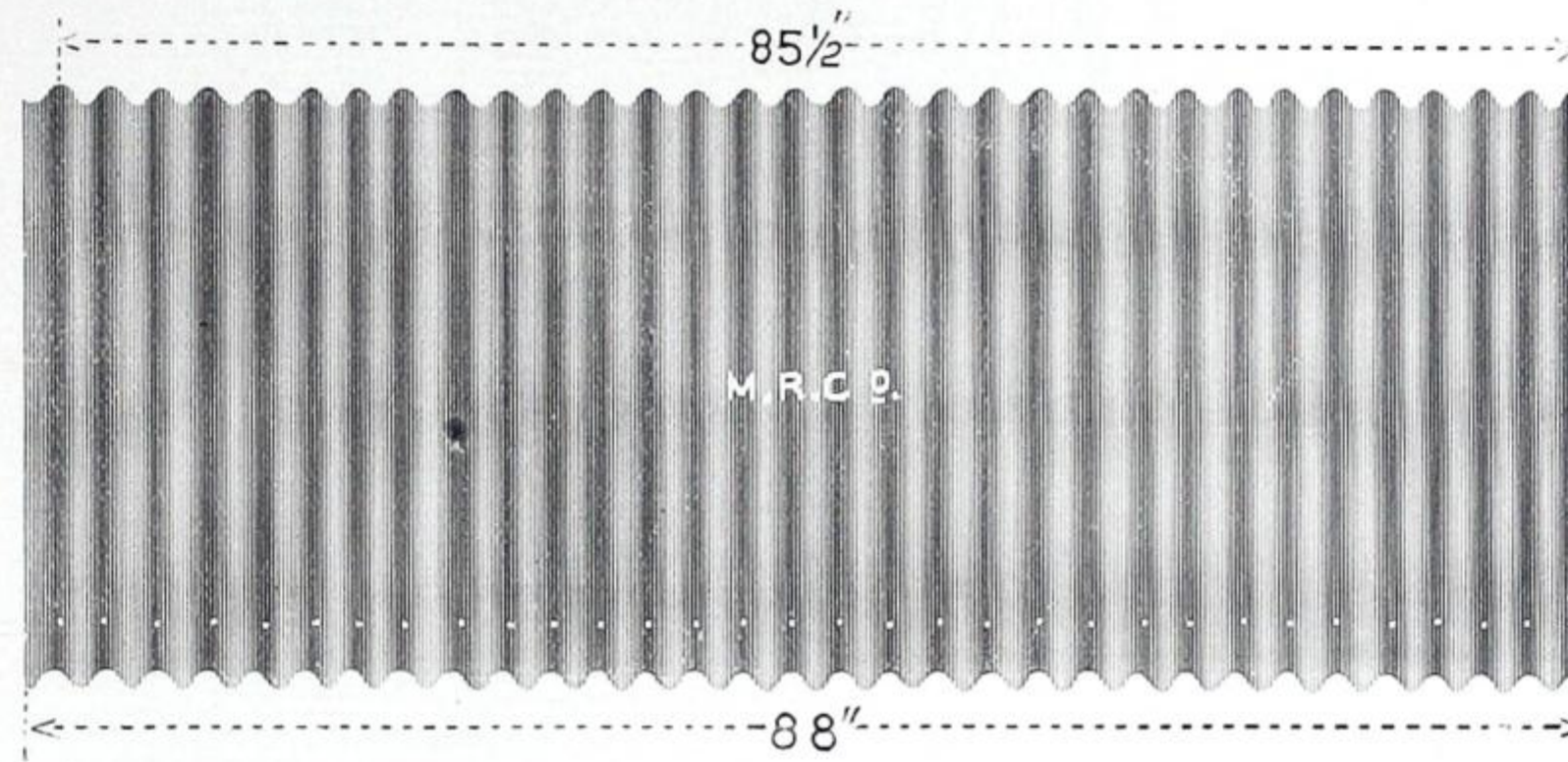

Fig. 105.

Another style of Elevator Siding, $2\frac{1}{2} \times \frac{5}{8}$ -inch corrugation, showing extreme width, also width, centre to centre, of outside corrugations. Sheets $2\frac{1}{2}$ or 3 feet deep. When so ordered, sheets are punched along bottom edge, all ready for nailing, as shown in the illustration.

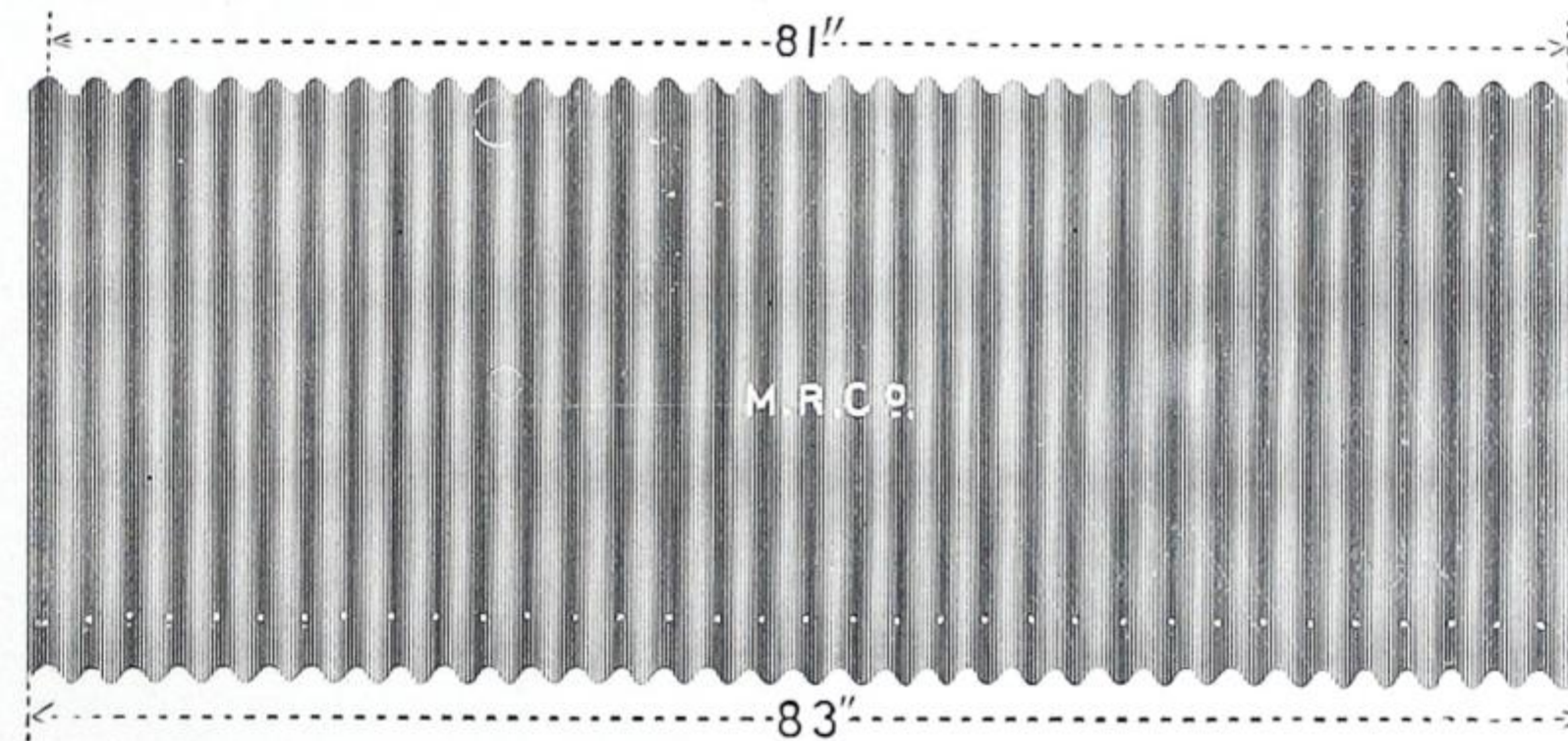

Fig. 106.

Shows same style of Elevator Siding as Fig. 105, except the corrugations are $2 \times \frac{5}{8}$ -inch. Sheets $2\frac{1}{2}$ or 3 feet deep.

In applying Elevator Siding, the sheets are laid in such a manner that the elevator sides have a chance to settle without disturbing the fastenings of the sheets. The sheets are laid with $1\frac{1}{2}$ inches end lap, and the nails are $1\frac{1}{2}$ inches above the upper edge of the lower sheets, thus allowing the sheets to slip $1\frac{1}{2}$ inches in twenty-four, thirty, thirty-six or forty-eight inches (depending on the length of the sheet used), as the sides of the elevator settle.



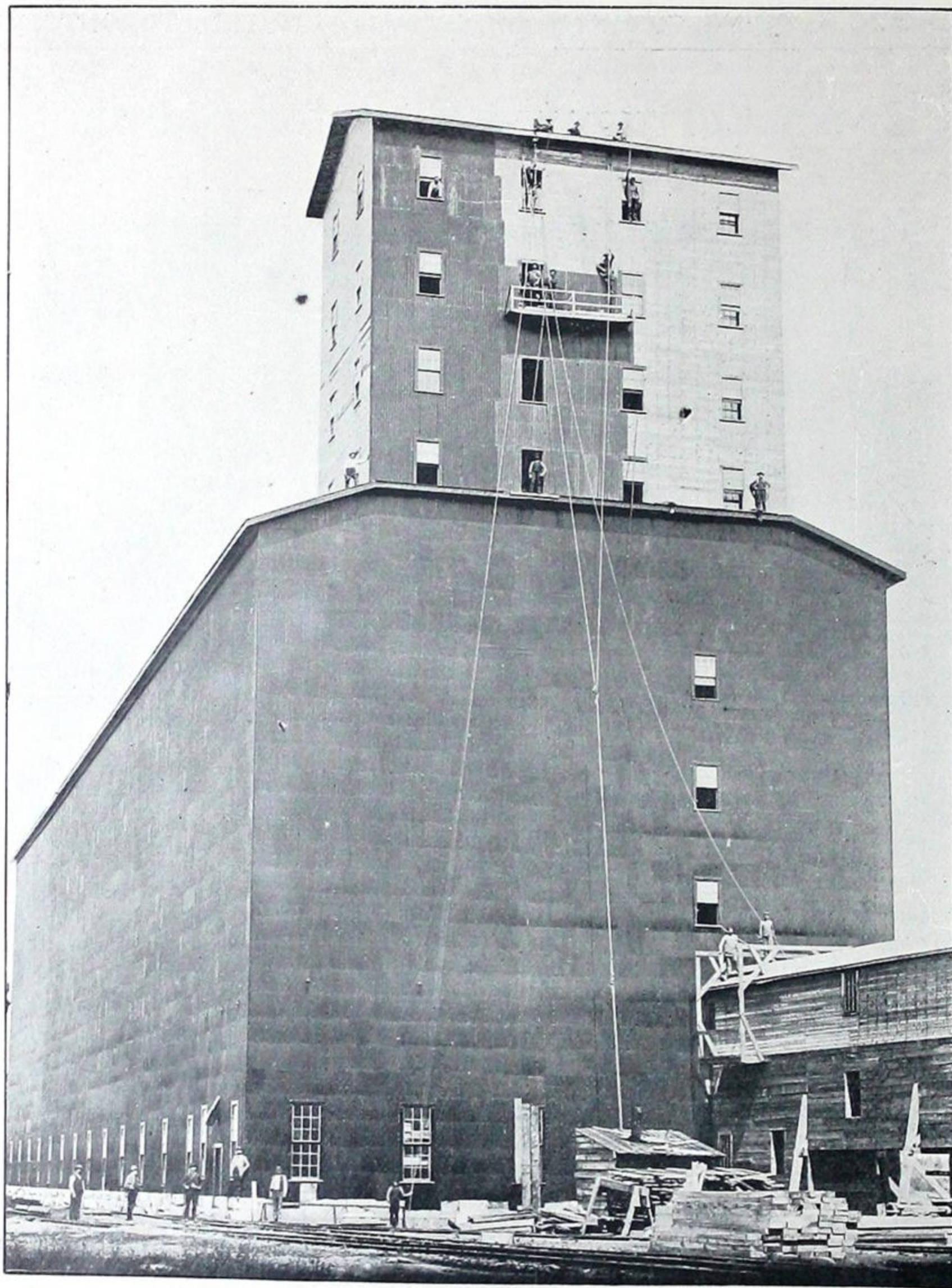

Fig. 107.—Canadian Pacific Railway Elevator “C” at Fort William, Ont.
Capacity, 1,300,000 bushels. Covered with the “Owl” brand of corrugated iron. From photo taken during progress of the work.

THE METALLIC ROOFING COMPANY OF CANADA, LIMITED, TORONTO, CANADA.

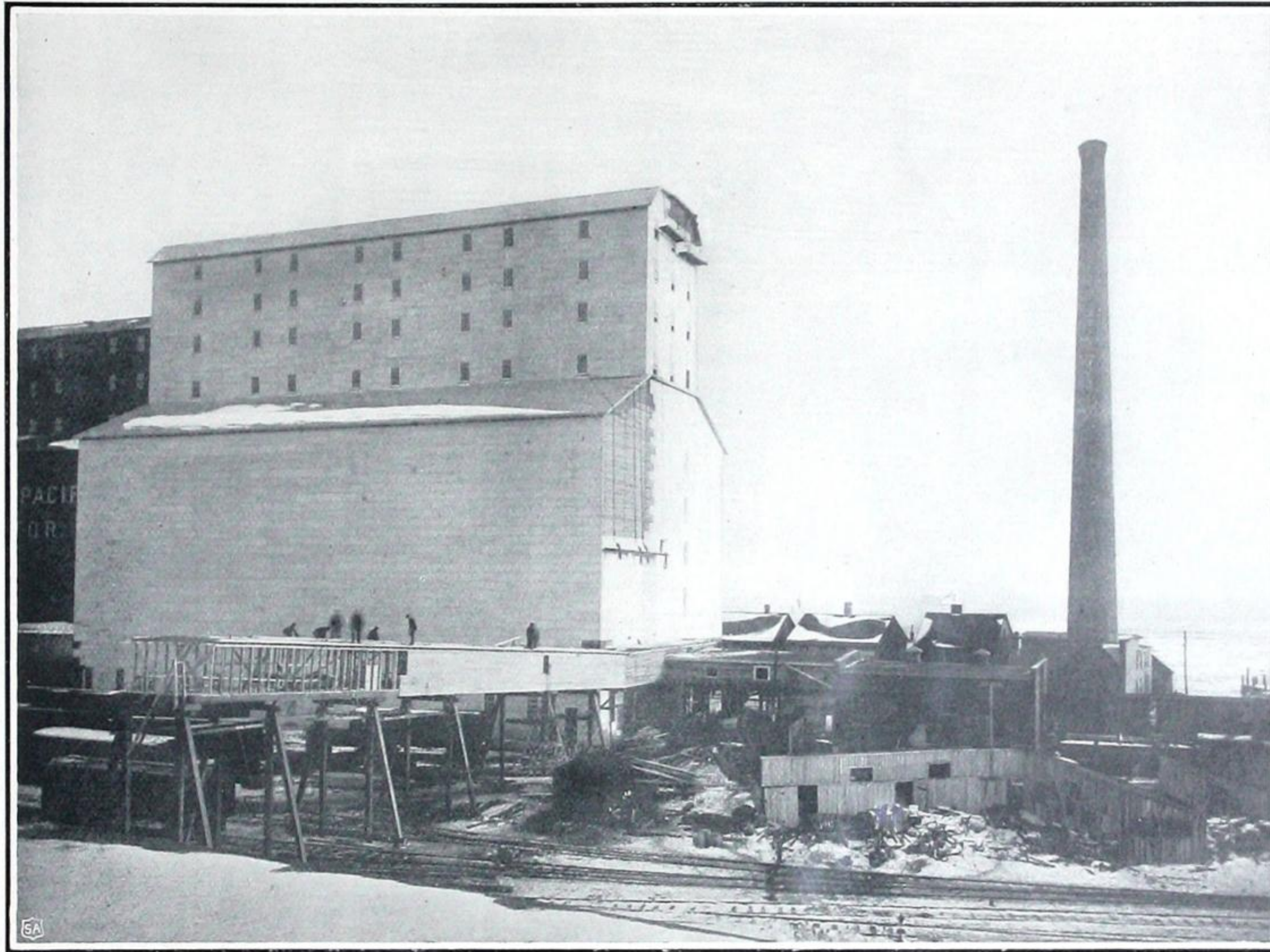

Fig. 108.

Canadian Pacific Railway Elevator at St. John, N. B.

Capacity, 1,000,000 Bushels.

Sides covered with our Galvanized Corrugated Elevator Siding; roof with galvanized "Eastlake" steel shingles.
For partial list of other elevators covered with our goods, see page 64.

THE METALLIC ROOFING COMPANY OF CANADA, LIMITED, TORONTO, CANADA.

Some Elevators Covered with our Goods.

Intercolonial Railway, Elevators at

Halifax, N. S.

St. John, N. B.

Oshawa Grain and Produce Company's Elevator at Oshawa, Ont.

Wm. Cook's Elevator at Meaford, Ont.

Ogilvy Milling Company, Elevators at

Altona, Man.	High Bluff, Man.	Oak River, Man.
Boissevain, Man.	Holland, "	Pettapiece, "
Carberry, "	Kemnay, "	Rosenfeld, "
Carman, "	Lauder, "	Stonewall, "
Cypress River, Man.	Melita, "	Viriden, "
Emerson, "	Methven, "	Winkler, "
Franklin, "	Midway, "	Moose Jaw, N. W. T.
Hartney, "	Neepawa, "	Sintaluta, "
Hamiota, "	Niverville, "	Wolseley, "

Northern Elevator Company, Elevators at

Cartwright, Man.	Carman, Man.	Napinka, Man.
Griswold, "	Reston, "	Indian Head, N. W. T.
Nesbitt, "	Ninga, "	McLean, "
Carroll, "	Carnduff, "	Balgonie, "
Findlay, "	Carberry, "	
Rathwell, "	Otterburne, "	

Canada North-West Elevator Company, Elevators at

Cypress River, Man.	Treesbank, Man.
Glenboro, "	Hartney, "

Lake-of-the-Woods Milling Company, Elevators at

Portage La Prairie, Man.	Melita, Man.	Thornhill, Man.
Boissevain, Man.	Elkhorn, "	Plum Coulee, Man.
Neepawa, "	Hartney, "	Rosenfeld, "
Altona, "	Souris, "	Dominion City, "
Winkler, "	Methven, "	Lauder, "
Morden, "	Carberry, "	White Water, "
Manitou, "	Douglas, "	Elva, "
Ninga, "	Griswold, "	Keewatin, Ont.
Arden, "	Viriden, "	Fleming, N. W. T.
Treesbank, "	Macdonald, "	Moosomin, "
Carroll, "	Gretna, "	Indian Head, "
Reston, "	Holland, "	
Franklin, "	Carman, "	

Bready, Love & Tryon, Elevators at

Oak Lake, Man.	Hilton, Man.	Summerberry, N. W. T.
Beresford, "	Ashdown, "	Sintaluta, "
Oak River, "	Killarney, "	Indian Head, "
Carman, "	Morden, "	Qu'Appelle, "
Myrtle, "	Minto, "	Wascana, "
Lowe Farm, "	Elgin, "	Lumsden, "
Oakville, "	Track-End, "	Moose Jaw, "
St. Agathe, "	Margaret, "	Boharm, "
Plum Coulee, "	Fairfax, "	Caron, "
Winkler, "	Baldur, "	Glen Ewen, "
Clearwater, "	Miami, "	Fleming, "
Carberry, "	Letellier, "	Regina, "
Roland, "	Kirkella, "	Oxbow, "
Rosebank, "	Grenfell, N. W. T.	Balgonie, "

THE METALLIC ROOFING COMPANY OF CANADA, LIMITED, TORONTO, CANADA.



Fig. 109.

Canadian Pacific Railway Freight Sheds, Toronto, 885 feet long.

Covered with "Owl" brand of Galvanized Corrugated Iron, applied direct to studding.

Method of Nailing Corrugated Iron.



Fig. 110.

Shows side lap and where to nail when used as siding.



Fig. 111.

Shows side lap of $1\frac{1}{2}$ corrugations, and where to nail when used as roofing.
(See also Fig. 123, page 72.)

Amount of Lap Required.

Corrugated roofing should have a lap of from three to six inches at the ends of sheets, and $1\frac{1}{2}$ or two corrugations at the sides. For siding, a lap of one to two inches at the ends, and one corrugation at the sides will be found sufficient.

Pitch of Roof.

We would not advise the use of corrugated iron on any roof of less pitch than three inches to the foot. Awnings would answer at $1\frac{1}{2}$ to two inches to the foot.

Distance Between Supports on Roof.

No. 18 gauge can be used on supports up to eight or nine feet apart.
Nos. 20 and 22 gauge can be used on supports up to six feet apart.
No. 24 gauge can be used on supports up to three or four feet apart.

No. 26 gauge can be used on supports up to two or three feet apart.
No. 28 should be applied to sheeting.

Curved Corrugated Sheets.

WE manufacture corrugated sheets curved to any specification required, in $2\frac{1}{2} \times \frac{5}{8}$ -inch corrugation only.

Curved ceilings, when painted suitably, present a very beautiful finish, and are very durable. The use of curved sheets for roofing, ceiling and other purposes is manifold, and often saves considerable expense in construction.

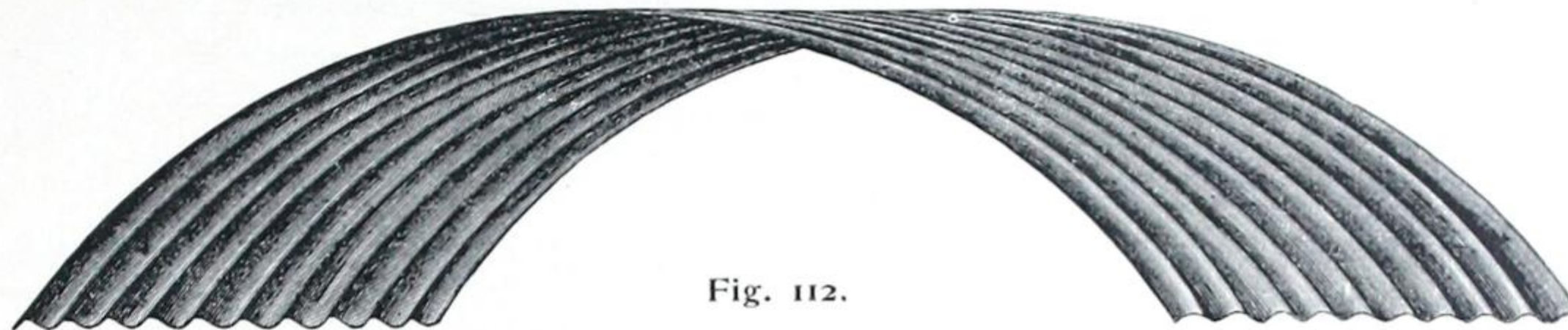

Fig. 112.

Shows corrugated sheet curved for roofs and ceilings. Sheets can be curved to any required radius.

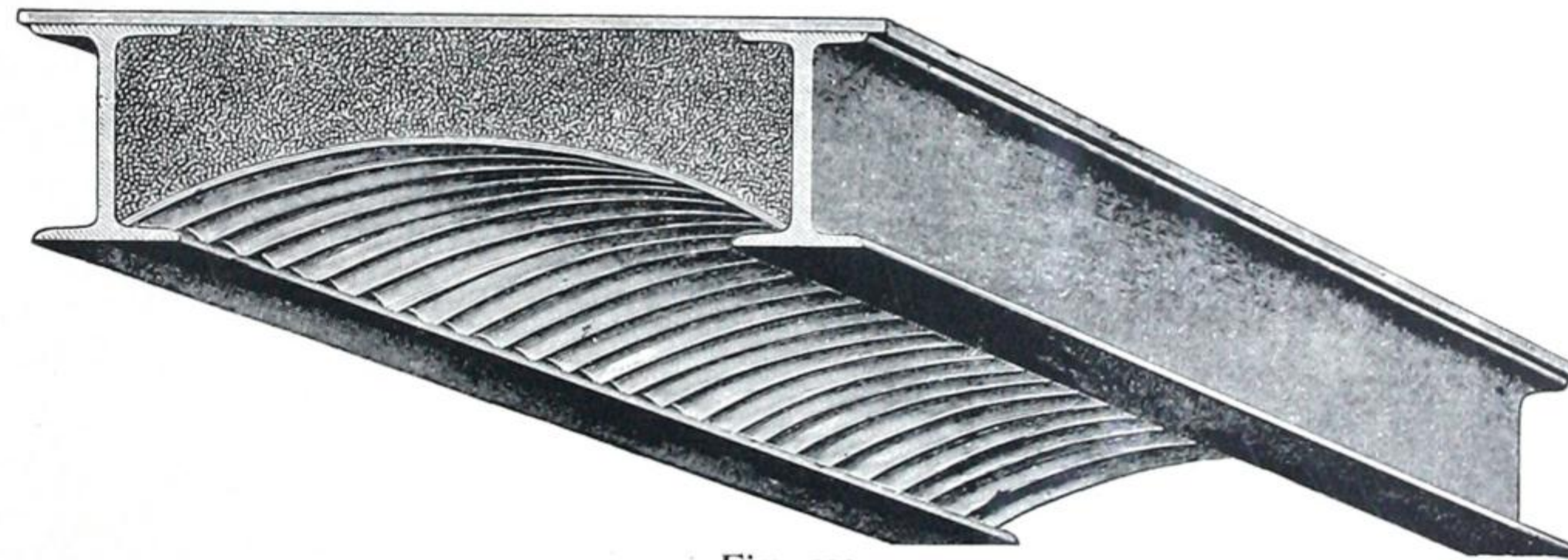

Fig. 113.

Shows application of curved corrugated iron on iron floor beams for ceiling in fire-proof buildings, after concrete filling is put in.

These arches, for strength, lightness, durability and fire-proof qualities, cannot be excelled. The weight of the arches, with concrete filling on top of them, is but little over half that of a brick arch, with concrete filling same height, thus allowing fewer or lighter beams to be used, and also lessening the load on the walls; besides being from twenty to thirty per cent. cheaper than brick arches, and consequently largely supplanting the use of the latter for fire-proof floors.

Corrugated arches have often been tested, and have never shown any deflection at a pressure of one thousand pounds per square foot, and little deflection at two thousand or three thousand pounds per square foot, using eighteen gauge iron. For tests, see article on "**Strength of Corrugated Iron.**"

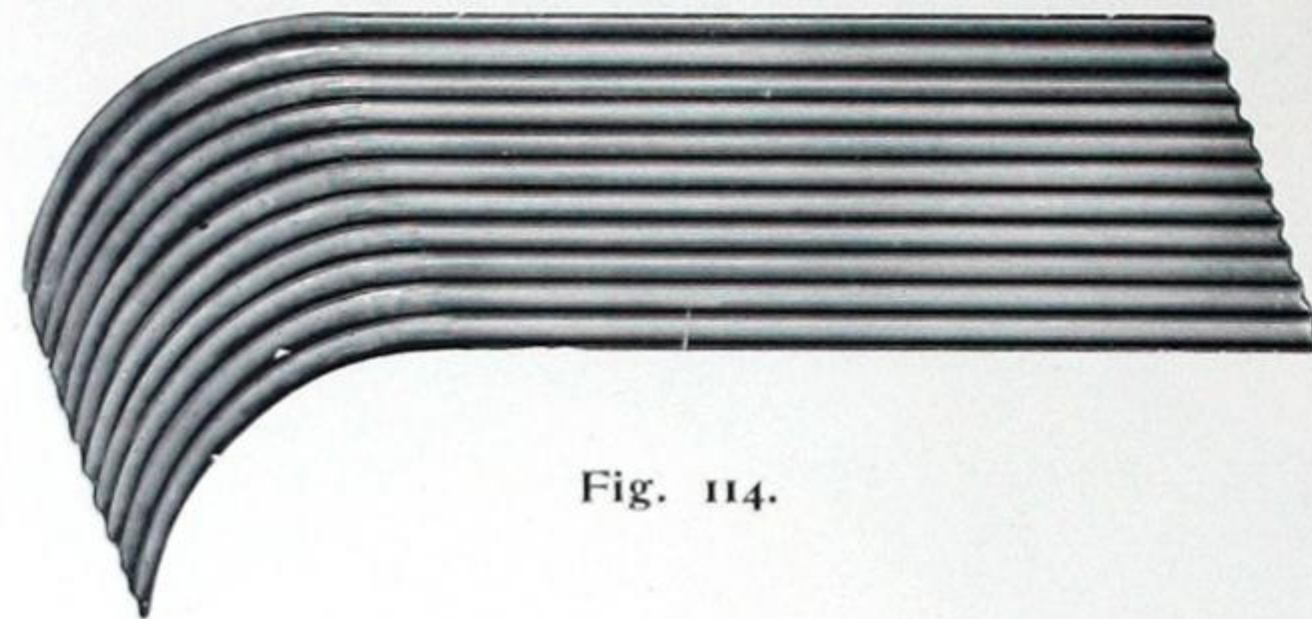

Fig. 114.

Shows corrugated sheet curved for permanent awning. Neat, cheap, light and durable.

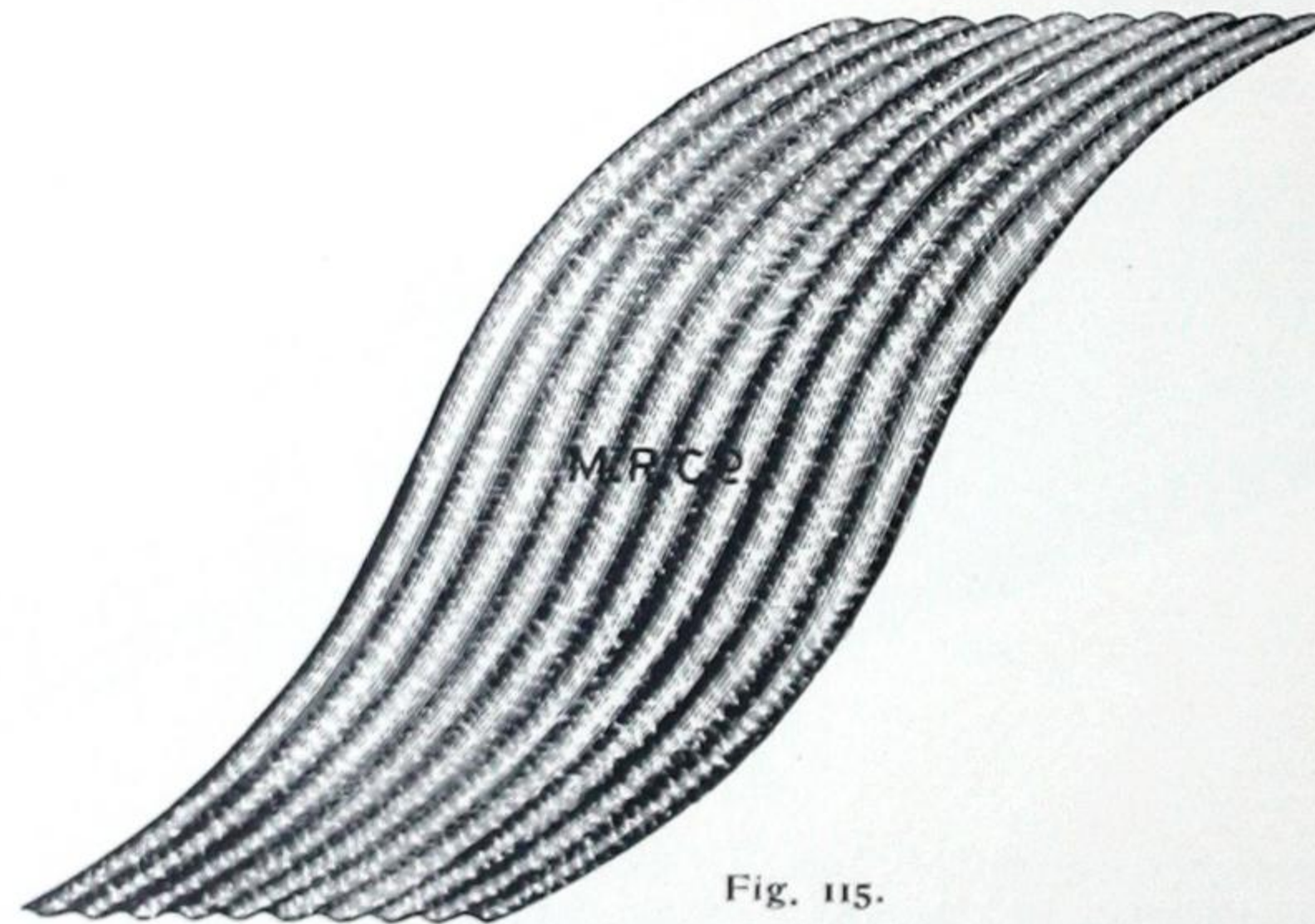

Fig. 115.

Shows double curved corrugated iron for ventilators and verandas.

Estimates for curved corrugated iron furnished on receipt of specification, showing distance between supports, amount of crown required, and length and number of spaces to be covered.

Corrugated Iron without Sheeting.

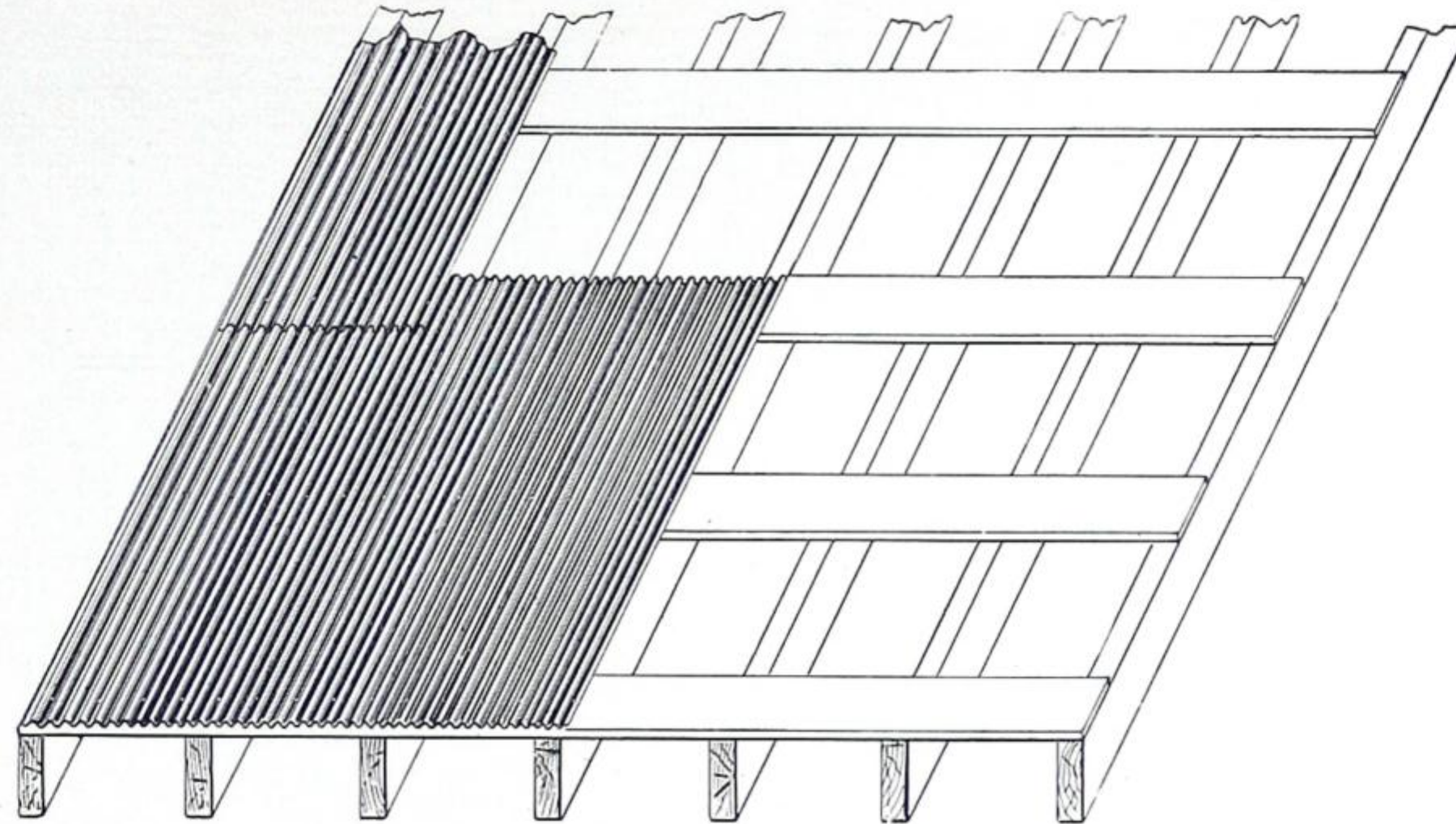

Fig. 116.



SHOWS the application of Corrugated Iron **without using any sheeting**. By this construction rough battens, an inch thick and say $2\frac{1}{2}$ to three inches wide, are nailed across the **top** of the rafters or studding every three or four feet apart, or more if heavy iron is used, and the iron nailed to the battens. The rafters are not necessarily set any particular distance apart, as the iron is supported by the battens.

All sheeting is saved, which amounts to a considerable item, and the whole building is braced and stiffened as effectually as if it had been sheeted with wood.

Another construction is to place the rafters the proper distance apart to suit the width of the iron, and fit cross supports between and flush with the top of the rafters, and then apply the iron.

When corrugated iron is used as siding, without sheeting, the sheet may be applied with corrugations running crosswise, direct to the studding, sixteen, eighteen or twenty-four inches apart, or the sheets may be laid vertically, the studding being placed the proper distance apart, depending on the width of iron used.

Corrugated Iron Partitions.

FIRE-PROOF partitions may be constructed in shops, factories and public buildings, etc., by applying Corrugated Iron direct to wood studding, in the same manner as when used for siding. The sheets of corrugated iron may be applied either vertically or horizontally as desired, and can be laid out in panels the same as for ceiling, and decorated in any way to suit the taste. Partitions constructed of wood studding, placed the proper distance apart, with the necessary supports placed between, and covered on both sides with corrugated iron, will be found to be just as fire-proof as brick, while costing no more than wood, or ordinary lath and plaster.

The corrugated iron will stiffen the entire wall, imparting additional strength thereto; the construction being such that all parts are thoroughly banded together; every line of joint is crossed or broken, each part reinforces each other, and the strength is equally distributed.

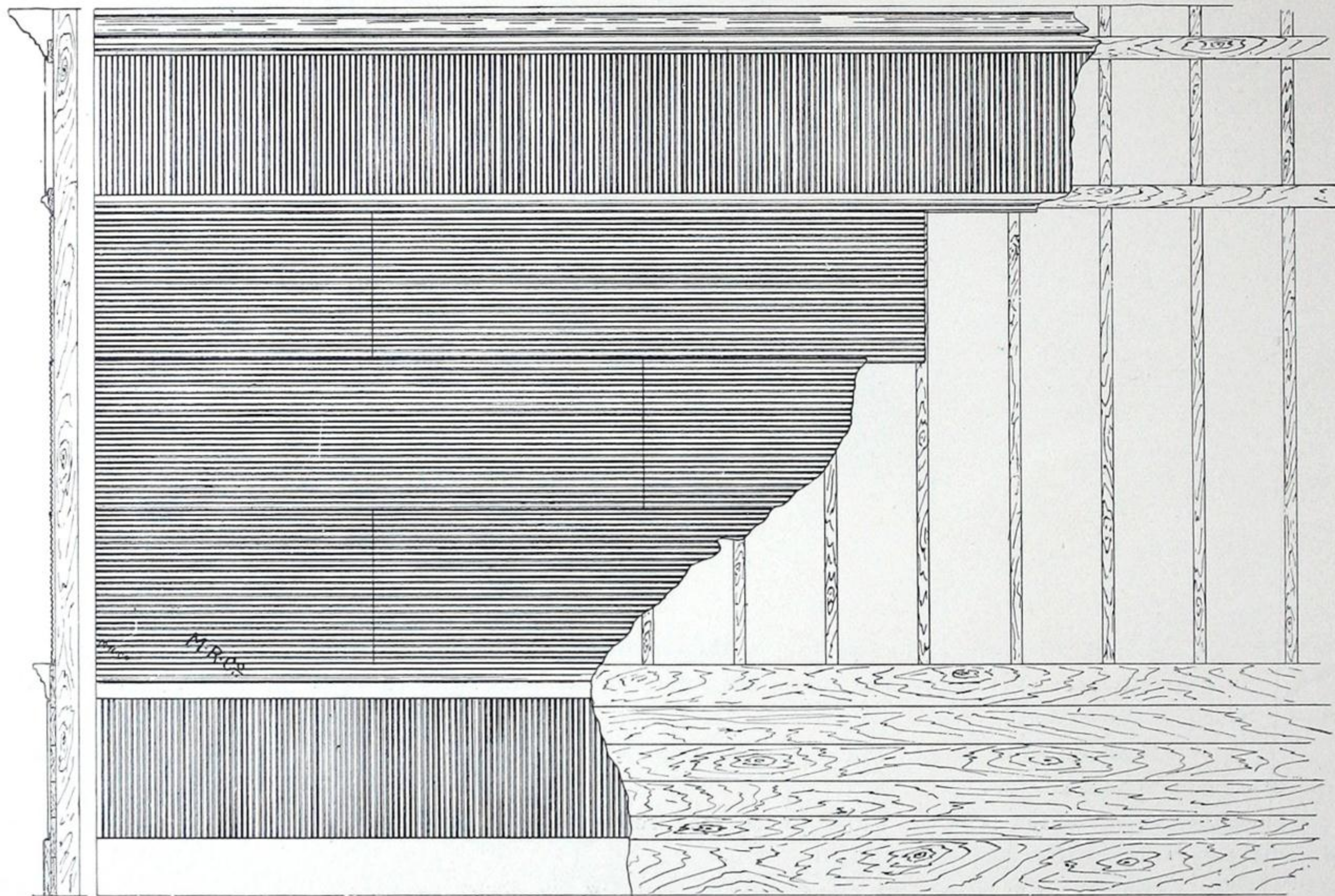

Fig. 117.

Corrugated Iron Fencing.

SUBSTANTIAL and durable fences can be constructed by using Corrugated Sheet Iron, instead of wooden boards. The sheets can be supplied in any length desired, with the tops notched, and can be applied by simply nailing them to supports, the same as are used for wooden boards. A fence thus constructed presents a very much better appearance than wood, and may be painted in any shade desired. The cost of keeping it painted is not nearly so much as wood, as the iron does not absorb paint, but it all remains on the outside, presenting a nice, smooth and even surface, which will stand the test of time and always look well.

Iron Frame Construction.

THERE are various methods employed of fastening Corrugated Iron to Iron framework. Clips of heavy galvanized iron may be securely rivetted to the corrugated sheets on the under side, and then bent around the framework or beams in such a way as to secure the roofing. Another and very much better and quicker way is to use bolts which hold to the beams and come through to the outside of the corrugated roofing on the top of the corrugation, and are fastened there with a nut run down tight on a malleable iron washer.

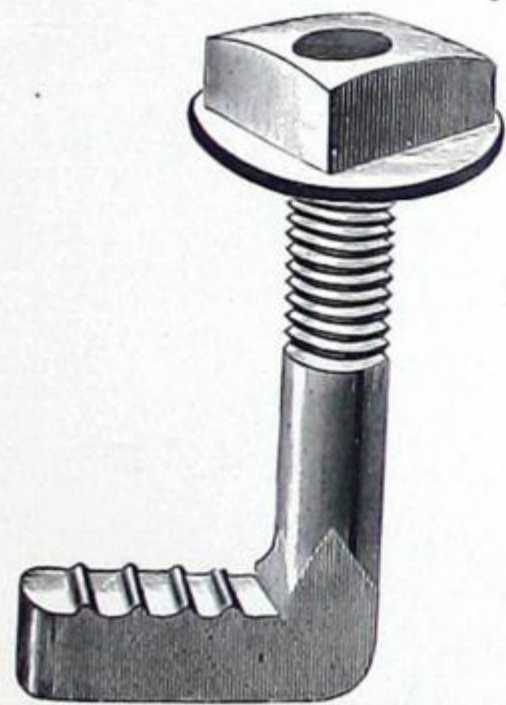

Fig. 118.

Shows hook bolt, with nut and washer. Bolt is malleable iron, dipped in boiling oil. Nut and washer are galvanized.



Fig. 119.

Illustrates a lead washer, which is frequently used between the malleable washer, shown in Fig. 118, and the corrugated iron. The lead being soft readily conforms to the shape of the corrugation, and when the nut is run down tight makes a perfect joint where the bolt comes through the roofing. About fifty washers to a pound.

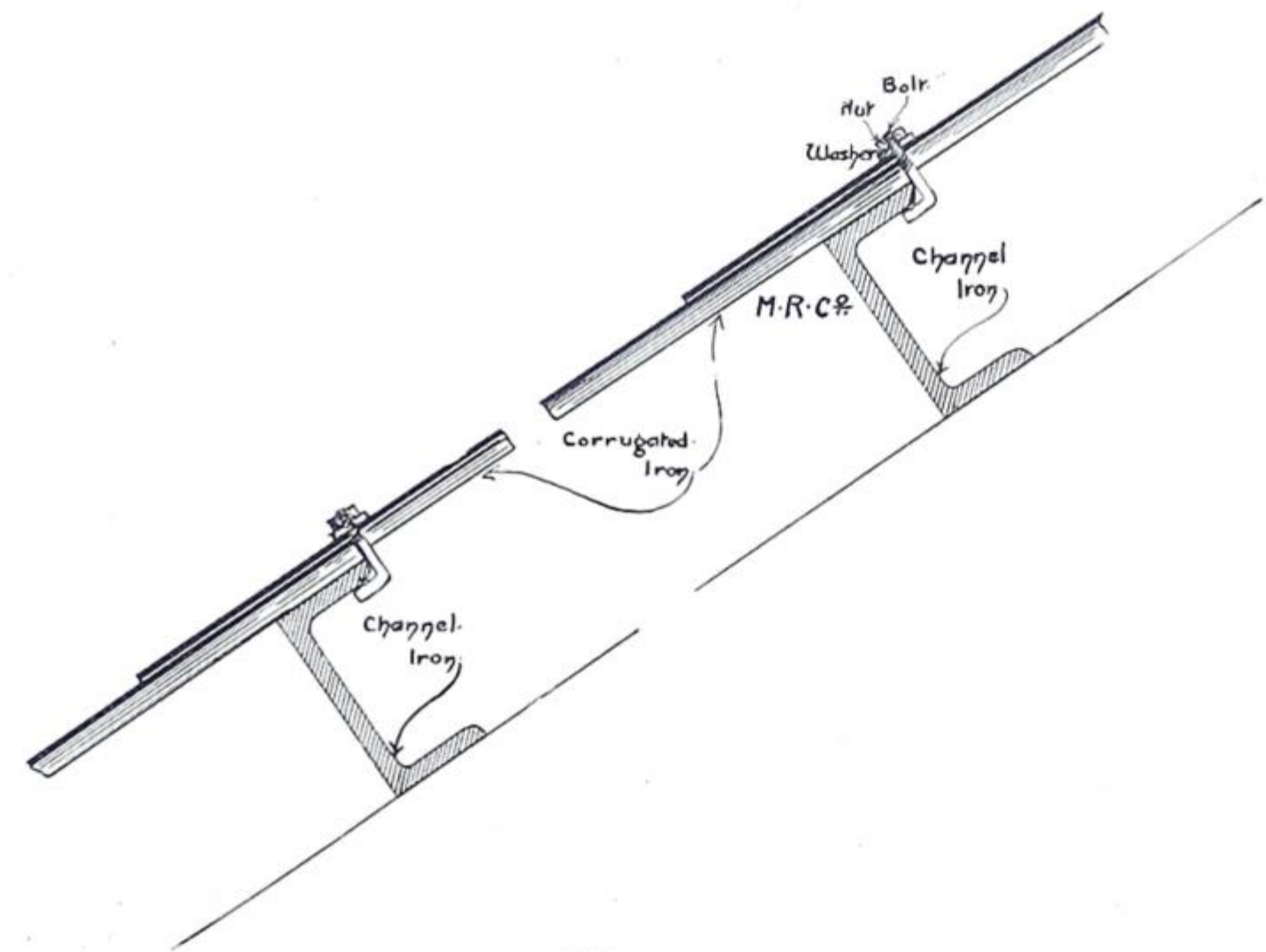

Fig. 120.

Shows the method of fastening the corrugated sheet to the iron framework with our special bolt, as illustrated in Fig. 118.

Iron Frame Construction.

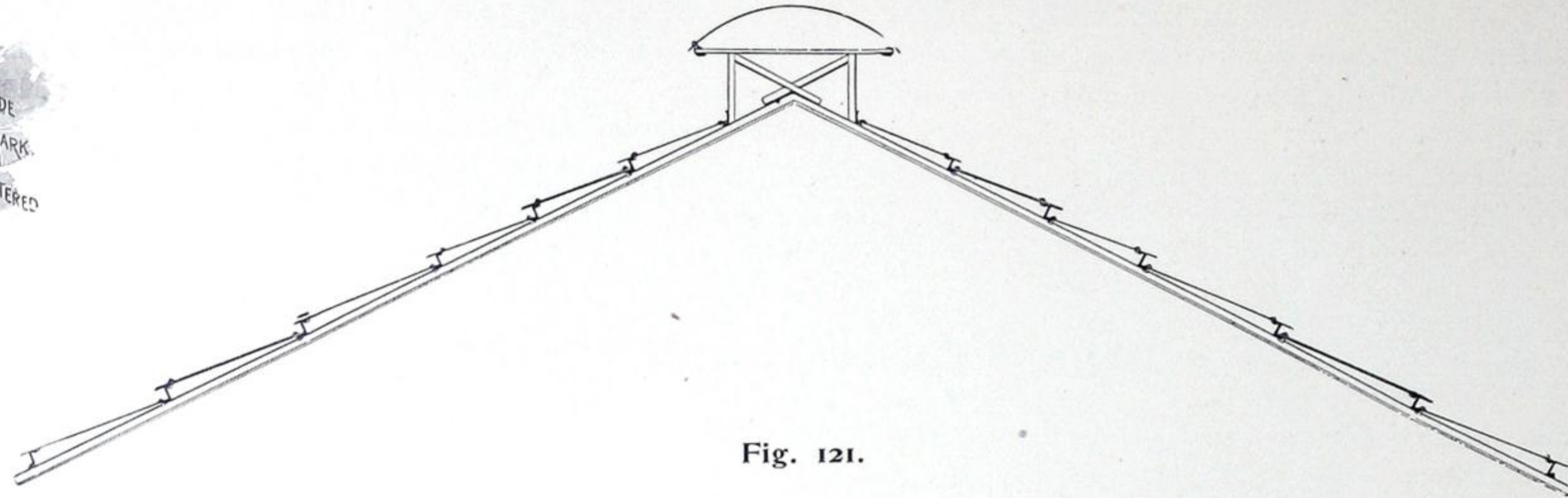

Fig. 121.

Section of the roof of the **Union Station, Toronto**, showing construction of the iron framework and method of fastening the corrugated roofing with bolt, as shown in Fig. 118. The bolt hooks under the flange on the **Z** bars and comes out through the corrugated iron and is fastened with the nut and washer run down tight.

The distance between the **Z** bars, commencing at the eave, is eight feet centres for the first three courses of roofing, and five feet ten inches for the remaining courses, and the curved corrugated iron at the top is twelve feet long.

All of the galvanized corrugated iron roofing, both straight and curved, used on the **Union Station, Toronto**, amounting to about **eighty-five tons**, was the "Owl" brand, supplied by us.

Lead Washers.



Fig. 122.

For use under Nail Heads when putting on Corrugated Iron, as shown in Fig. 123.

They make a perfectly water-tight joint, and prevent rust accumulating under the nail head, thus making a more durable job. One pound contains about three hundred washers.

The additional cost of doing a job with these washers is trifling, while by their use a perfect job is made.

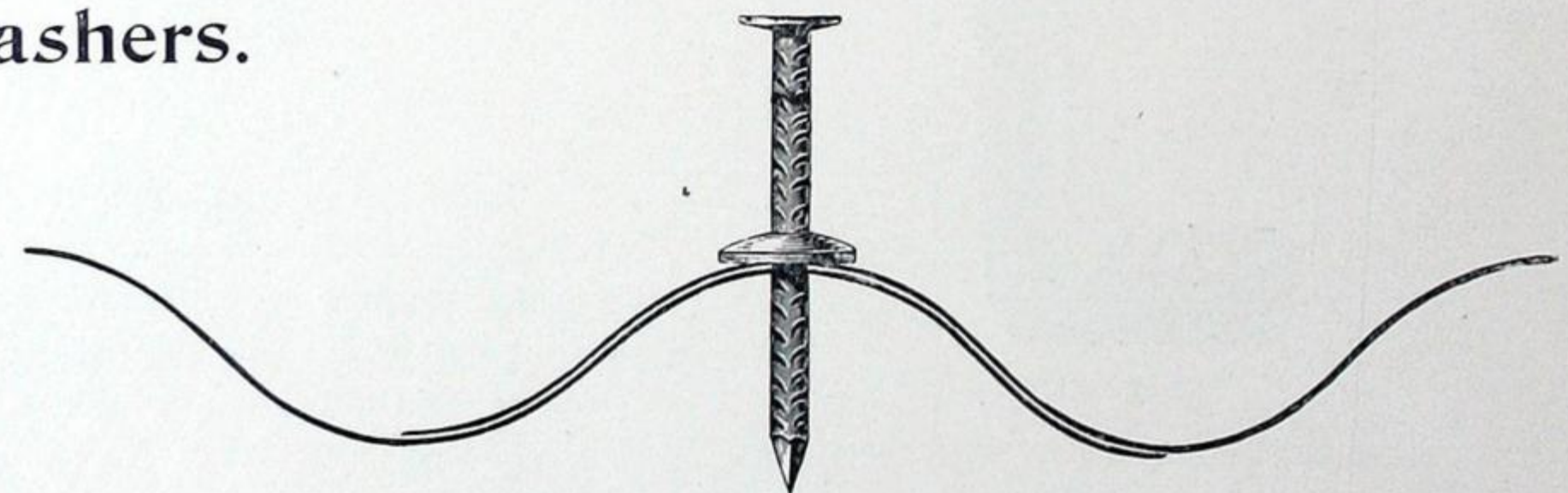

Fig. 123.

Shows the Application of Lead Washers.

THE METALLIC ROOFING COMPANY OF CANADA, LIMITED, TORONTO, CANADA.

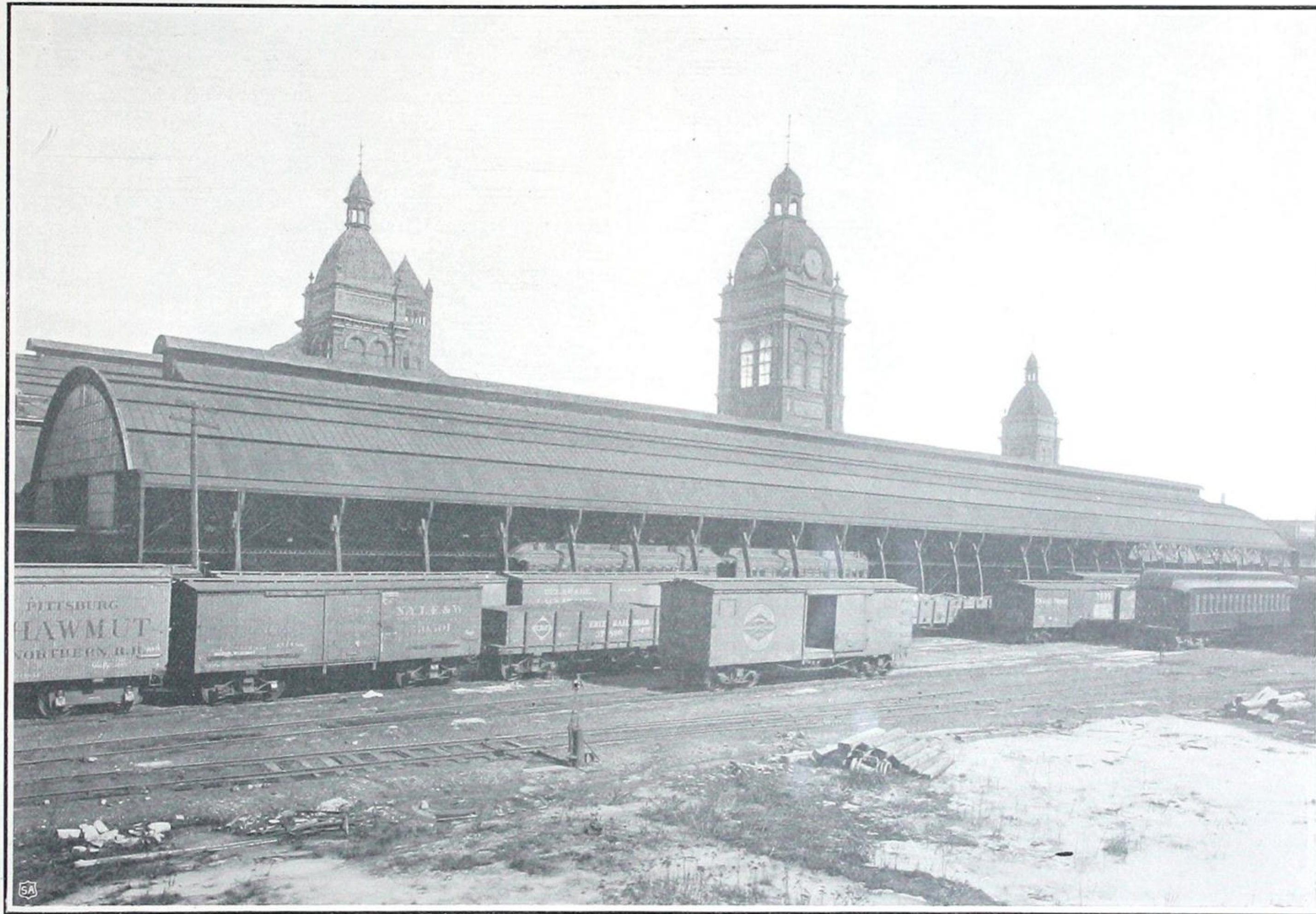

Fig. 124.—Union Station, Toronto.

Covered with the "Owl" brand of Galvanized Corrugated Iron.

THE METALLIC ROOFING COMPANY OF CANADA, LIMITED, TORONTO, CANADA.

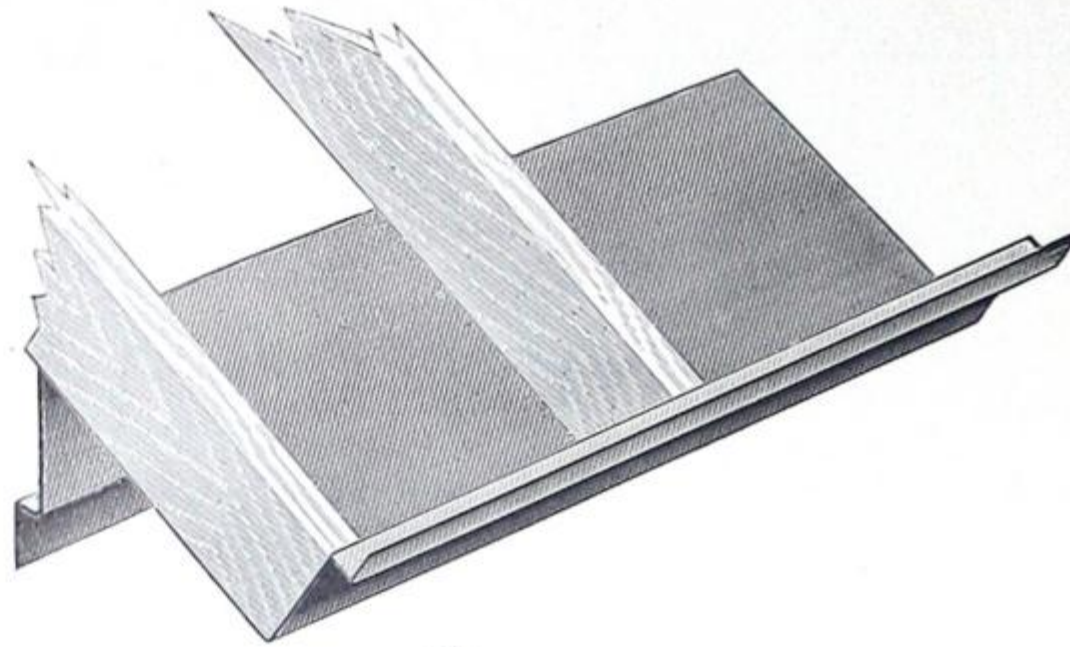

Fig. 125.

Shows section of Sheet Iron Cornice as applied on rafters. This is used largely on grain elevators, foundries and all kinds of manufacturing buildings. Can furnish any length up to eight feet, to suit the distance between rafters, and for any size and design of cornice.

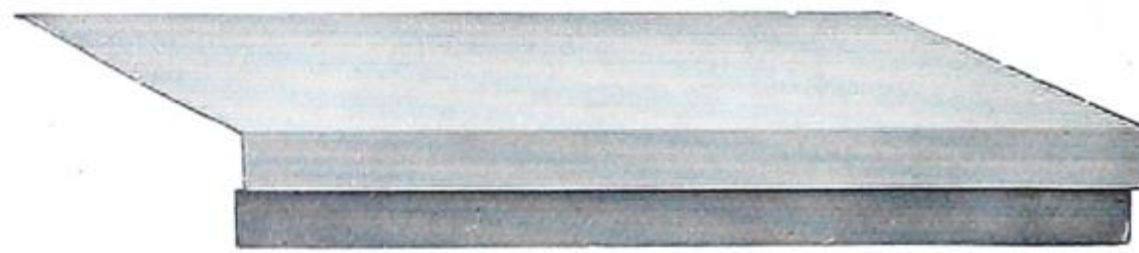

Fig. 126.

Shows Sheet Iron Window Sill for use in covering sills of windows. Made to order in lengths to fit the sills of windows. We also furnish to order sheet iron door casing and jamb, for use in casing door frames.



Fig. 127.

Window Frame Casing, made to order in sizes to fit the casings.



Fig. 128.

Shows **corrugated wood**, made in sections, for use at ridge of roof and also under the corrugated iron at the eaves.

The wood is flat on one side and corrugated on the other side, to fit the corrugations of the roofing.

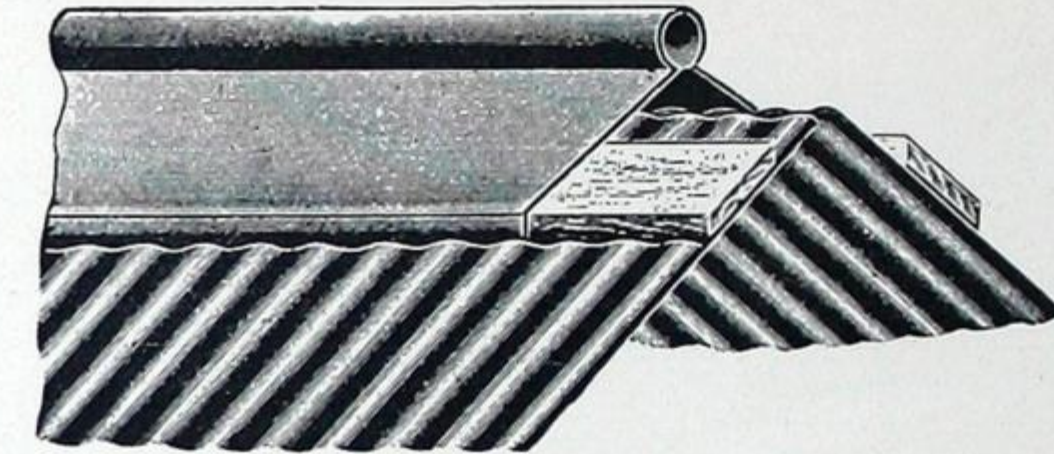

Fig. 129.

Shows the application of our corrugated wood and ridge cap on corrugated iron roofing at the ridge.

Galvanized ridge cap, fifteen or eighteen-inch girth.
Painted ridge cap, fifteen-inch girth.



Fig. 130.

Shows our Corrugated Iron Flashing for side walls where corrugated iron is used. Made in either galvanized or painted iron.

Strength of Corrugated Iron.

In order to **prove** the great strength that corrugated iron possesses, both straight and curved, we publish below some severe tests to which it has been subjected by eminent engineers, whose authority on such matters is beyond question.

From "The Architects' and Builders' Pocket-Book."

By Frank Eugene Kidder, C.E.,
Consulting Architect, Boston.

Results of a test of a **straight** sheet of twenty gauge corrugated iron, **six feet long between supports**, loaded uniformly with fire clay. Corrugations $2\frac{1}{2} \times \frac{5}{8}$ inch.

Load per square foot in pounds.	Deflection at centre under load, in inches.	Permanent Deflection, load removed, in ins.	Load per square foot, in pounds.	Deflection at centre under load, in inches.	Permanent Deflection, load removed, in ins.
5	$\frac{1}{2}$	0	35	$2\frac{1}{4}$	$\frac{1}{2}$
10	$\frac{3}{4}$	0	40	$2\frac{5}{8}$	$\frac{3}{4}$
15	1	0	45	$3\frac{1}{2}$	$1\frac{1}{8}$
20	$1\frac{1}{4}$	0	50	4	$1\frac{1}{2}$
25	$1\frac{1}{2}$	0	55	$6\frac{1}{2}$	Not noted
30	$1\frac{7}{8}$	$\frac{1}{8}$	60	Broke down	"

From "Trautwine's Engineers' Pocket-Book," 20th Edition.

"FIRST—A **straight sheet** of sixteen gauge iron, twenty-seven inches wide by four feet long, with five complete corrugations of five inches by one inch, was laid on

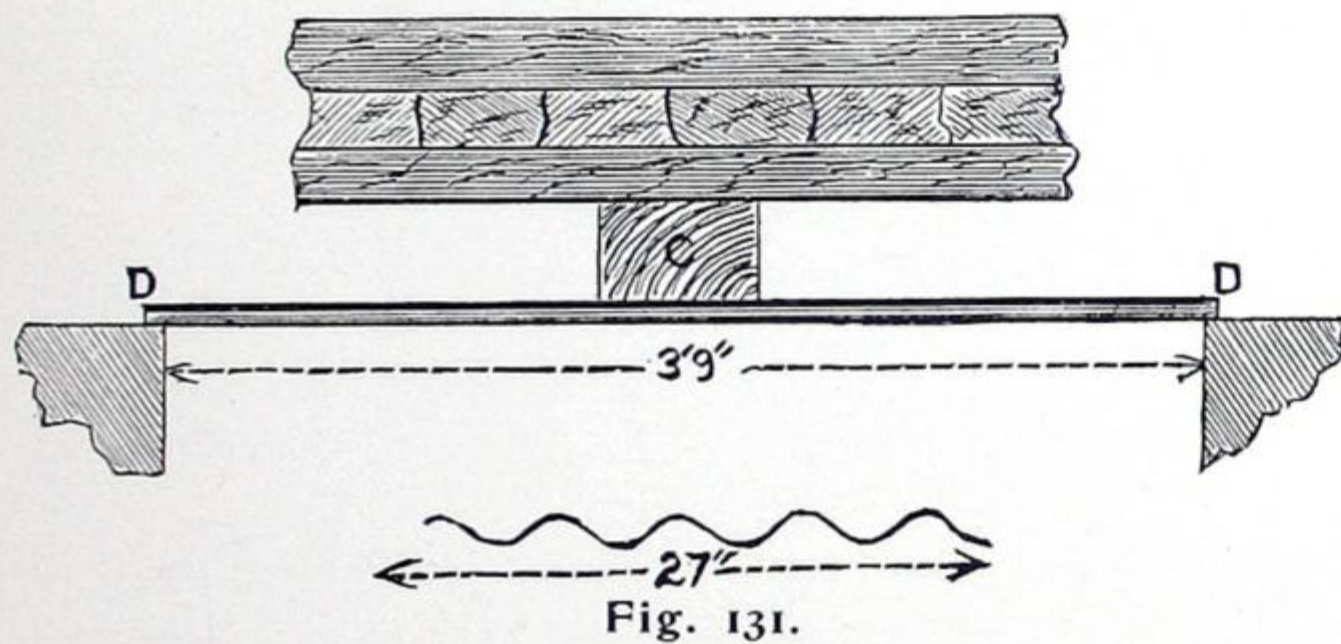

Fig. 131.

supports three feet nine inches apart. A block of wood nine inches wide by seven inches thick and thirty inches long was placed on the **centre**, and loaded with castings weighing **1,600 pounds**. This caused a deflection at the centre of one-half inch. On the removal of the load, after an hour, no permanent set was appreciable. The severity of the test was purposely increased by applying the several castings very roughly, jolting the whole as much as possible. The suspended area of the sheet was 8.44 square feet, and since the actual centre load of 1,600 pounds is equivalent to **3,000 pounds equally distributed**, it amounts to $3,000 \div 8.44 = 355$ pounds per square foot, distributed. **355 pounds per square foot is about four times the weight of the greatest crowd that**

could well congregate upon a floor, consequently this iron, at three feet nine inches span, is safe in practice for any ordinary crowd; moreover, such a crowd would produce a deflection of only the one-quarter part of one-quarter inch, or one-sixteenth of an inch, $\frac{1}{16}$ of the clear span, which is but two-thirds of 'Treadgold's' limit of $\frac{1}{48}$ of the span (see Article 26 of 'Strength of Materials,' page 196). The experiments were tried both on flat supports, with lower points of corrugations alone touching, and on supports dressed to conform to the shape of the corrugations, but in each case no appreciable difference in the result was observed.

"SECOND—An arch of number eighteen gauge iron, corrugated like in the foregoing test, but the depth of the corrugations increased to one and one-quarter inches by the process of arching the sheet: clear span, six feet one inch; rise, ten inches; breadth, twenty-seven inches (of which, however, only twenty-five inches rested against the abutments).

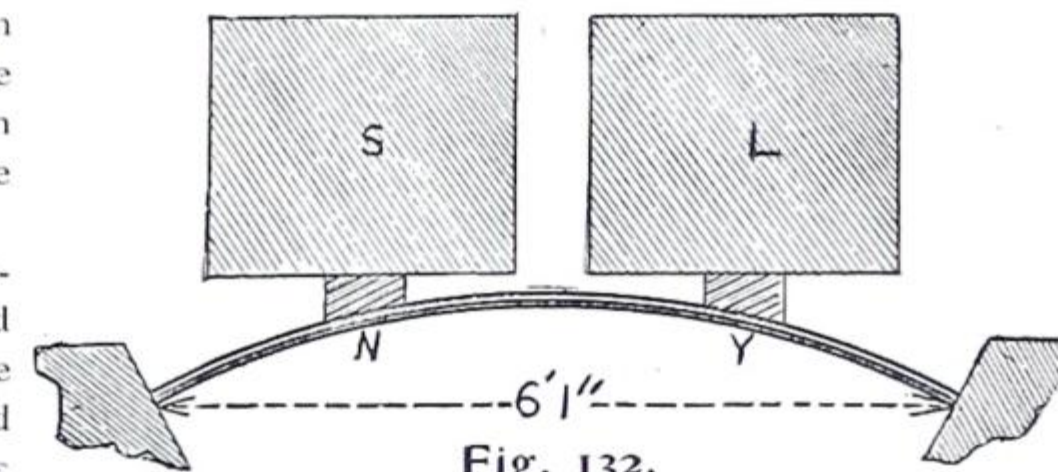

Fig. 132.

"Each foot of the arch abutted upon a casting, the inner portion of which was undulated on top to correspond with the corrugations of the arch which rested upon it. At **Y** (one-fourth of the span) two wooden blocks were placed, occupying a width of nine inches, and extending across the arch; on them was piled a load of castings to the extent of **4,480 pounds, or two tons**. Under this load the arch descended about one-half of an inch at **Y**, becoming flatter along that side, and slightly more curved upward along the unloaded side **N**. Two similar blocks were then placed at **N**, and two tons of load, **S**, were piled upon them, in addition to the two tons at **L**, making a **total of 8,960 pounds, or four tons**. This brought the arch more nearly back to its original shape, but still slightly straightened at both **N** and **Y**, and a little more curved in the centre. The load was then increased to ten thousand pounds and left standing for several days. Two iron ties, each one-half by one and three-quarter inches, which were used for preventing the abutment casing from spreading, were found to have stretched nearly one-quarter of an inch; additional ones were inserted, and the load increased to a total of six tons, or 13,440 pounds, parts of it on **S** and **L**, and part in the shape of long broad bars of iron at the centre of the arch, below the loads **S** and **L**, and between **N** and **Y**. So far as could be judged by the eye, the shape of the arch was perfect. The loads **S** and **L** did not touch each other. After standing more than a week the load was accidentally overturned, crippling the arch. The load was equal to about **one thousand pounds per square foot of the arch**. Such arches have since come into common use instead of brick for fire-proof floors."

Corrugated Iron Awnings.

Neat, Light in Weight, Strong and Durable.

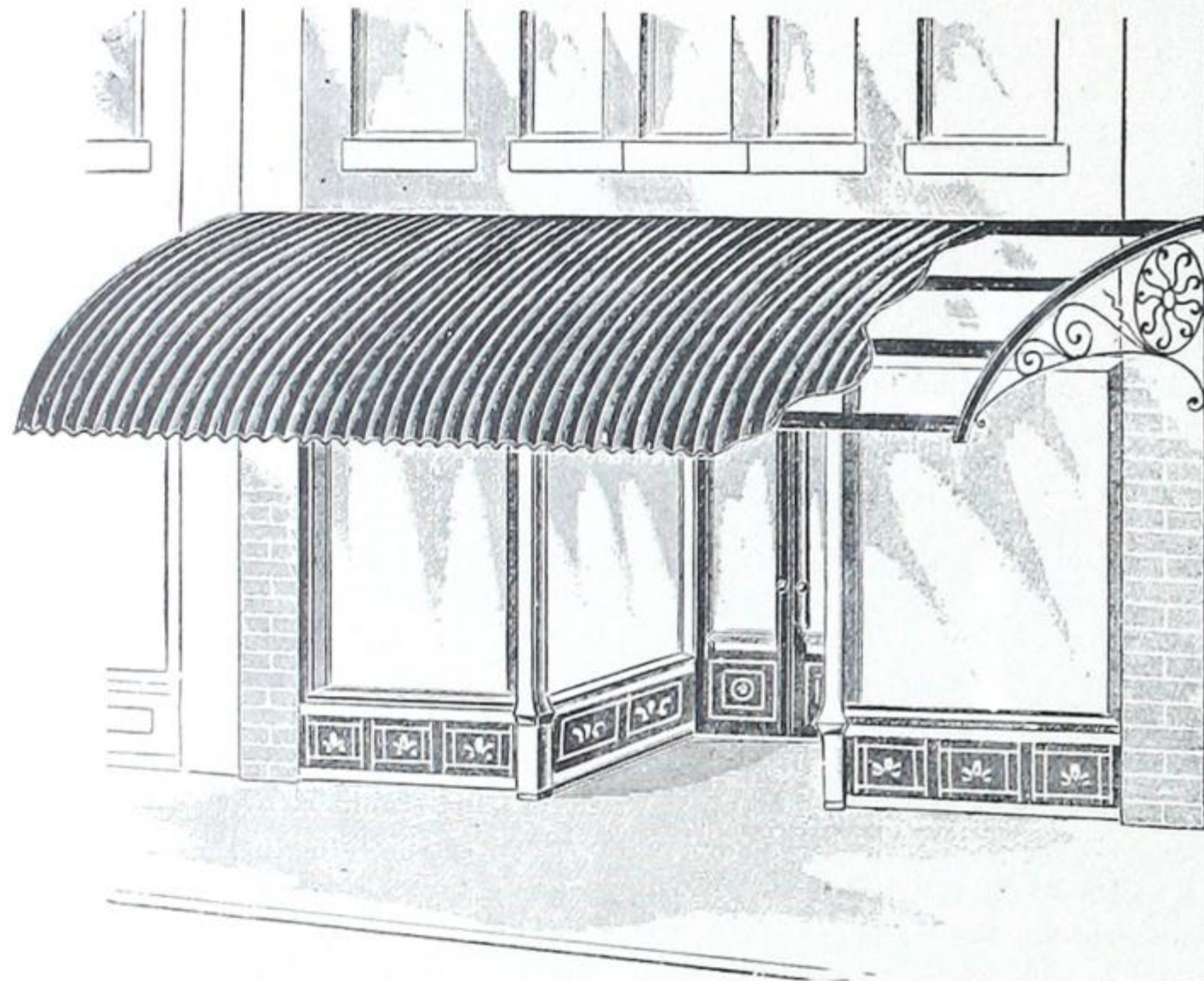
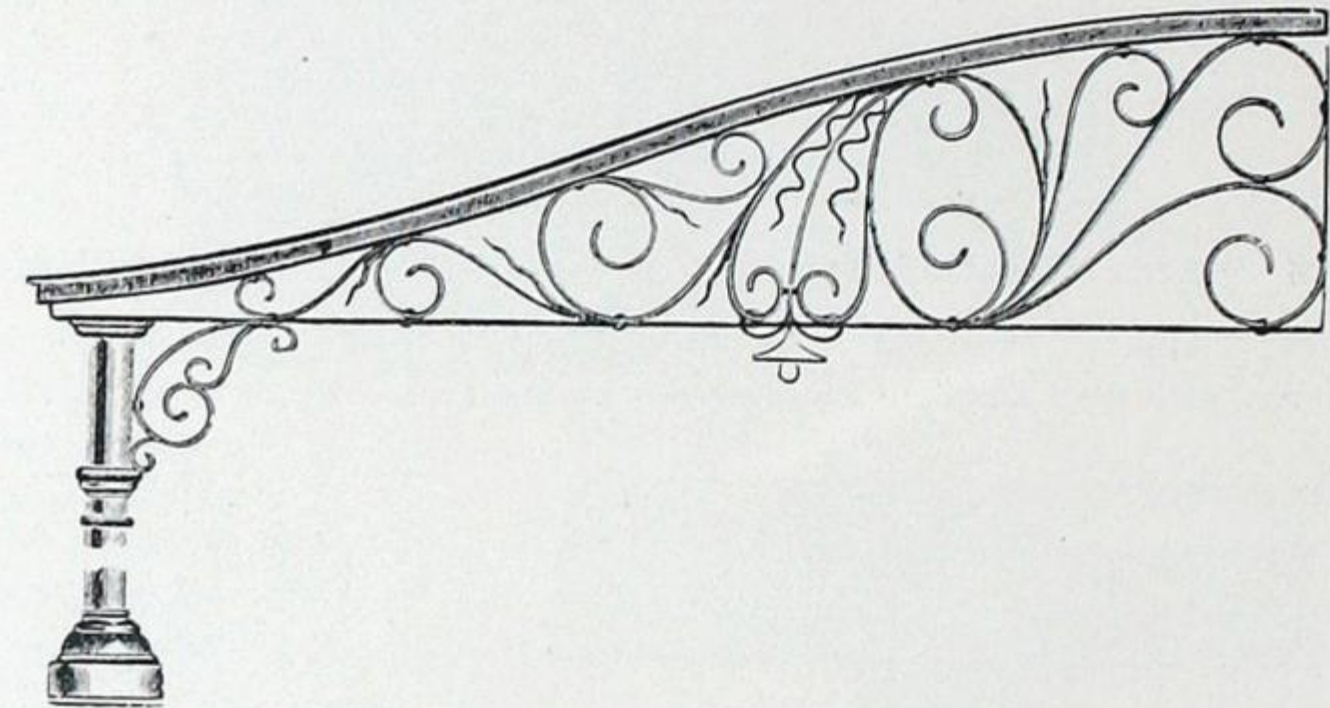

Fig. 133.

Shows a curved, corrugated Iron Awning, complete, with wrought iron supports.

Estimates furnished for complete awnings on receipt of specifications.

Wrought Iron Awning Supports.



Design No. 1000.

For awnings to be covered with corrugated iron. If desired, they may be roofed with glass.

Estimates furnished on receipt of specification showing size.

THE METALLIC ROOFING COMPANY OF CANADA, LIMITED, TORONTO, CANADA.

Wrought Iron Awning Supports.



Design No. 1001.

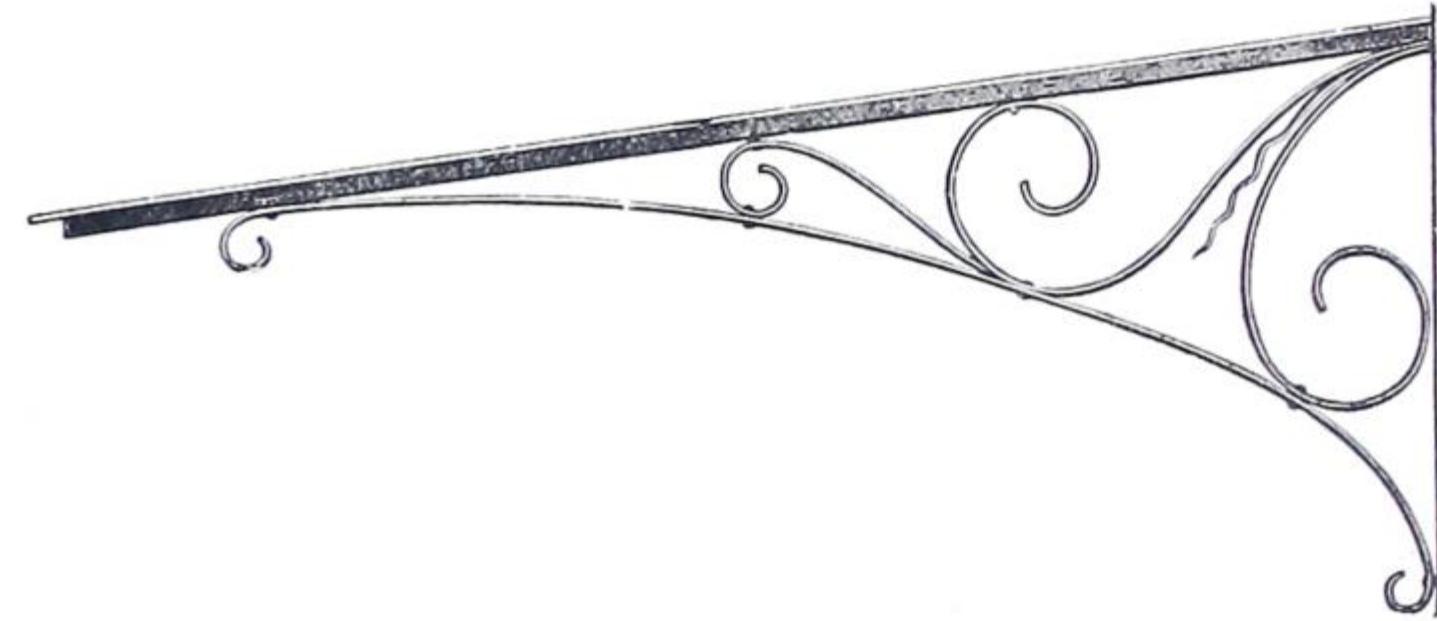

Design No. 1002.



Design No. 1003.

Prices quoted on receipt of information giving projection required, and what quantity is wanted.

Amount of Corrugated Iron We Give for a Square.

ALL our corrugated sheets are sold by the one hundred square feet, extreme measure, **no allowance whatever being made for laps.** We do this for the reason that the amount that it takes to cover a square depends on the size of sheets used, the size of the corrugations, and the amount of lap given in laying. The greater the lap the more metal it takes, and consequently the more it costs by the square when laid.

Table Showing the Covering Widths of Various Sheets.
Allowing for Different Side Laps.

Size of Corrugation.	Extreme Width of Sheets.	One Corrugation.	Two Corrugations.
2 1/2 x 5/8 ins.	33 inches.	30 1/2 inches.	28 inches.
2 1/2 x 5/8 "	27 1/2 "	25 "	22 1/2 "
2 1/2 x 5/8 "	*88 "	85 1/2 "
2 1/2 x 5/8 "	*66 "	63 1/2 "
2 x 5/8 "	31 "	29 "	27 inches.
2 x 5/8 "	26 "	24 "	22 "
2 x 5/8 "	*83 "	81 "
2 x 5/8 "	*62 "	60 "
1 x 1/4 "	32 "	31 "
1 x 1/4 "	26 1/2 "	25 1/2 "

Sheets marked * are corrugated crosswise.

Contents of Corrugated Sheets as Figured in Selling.

Size of Corrugation.	Total Length of Sheets.	Extreme Width of Sheets.	Contents in Square Feet.
2 1/2 inch.	96 inches.	33 inches.	22 feet.
2 1/2 "	96 "	27 1/2 "	18 1/3 "
2 1/2 "	72 "	33 "	16 1/2 "
2 1/2 "	72 "	27 1/2 "	13 3/4 "
2 1/2 "	*88 "	36 "	22 "
2 1/2 "	*88 "	30 "	18 1/3 "
2 1/2 "	*66 "	36 "	16 1/2 "
2 1/2 "	*66 "	30 "	13 3/4 "
2 "	96 "	31 "	20 2/3 "
2 "	96 "	26 "	17 1/3 "
2 "	72 "	26 "	13 "
2 "	*83 "	36 "	20 2/3 "
2 "	*83 "	30 "	17 1/3 "
2 "	*62 "	36 "	15 1/2 "
2 "	*62 "	30 "	13 "
1 "	96 "	32 "	21 1/3 "
1 "	96 "	26 1/2 "	17 2/3 "
1 "	72 "	26 1/2 "	13 1/4 "

Sheets marked * are corrugated crosswise.

Amount of Corrugated Iron Required to Cover a Square, when Laid, Allowing for Different Laps.

Sheets Corrugated Lengthwise.

Full Width of Sheets.	Size of Corrugation.	For Side Lap of	And 1 Inch End Lap—sq. feet.	And 2 Inches End Lap—sq. feet.	And 3 Inches End Lap—sq. feet.	And 4 Inches End Lap—sq. feet.	And 5 Inches End Lap—sq. feet.	And 6 Inches End Lap—sq. feet.
33 inches.	2½ × 5 inches	1 corrugation.	109½	110½	111½	113	114½	115½
33 "	2½ × "	1½ "	115	116½	117½	118½	120	121½
33 "	2½ × "	2 "	121½	122½	123½	125	126½	128
27½ "	2½ × "	1 "	111½	112½	113½	114½	116½	117½
27½ "	2½ × "	1½ "	118½	119½	120½	122½	123½	125
27½ "	2½ × "	2 "	126½	127½	128½	130½	132	133½
*27½ "	2½ × "	1 "	111½	113½	115	116½
31 "	2 × "	1 "	108½	109½	110½	111½	112½	114
31 "	2 × "	1½ "	112½	113½	114½	116	117	118½
31 "	2 × "	2 "	116½	117½	118½	120	121½	122½
26 "	2 × "	1 "	109½	110½	111½	113	114½	115½
26 "	2 × "	1½ "	114½	115½	117	118½	119½	120½
26 "	2 × "	2 "	119½	120	122	123	124½	126
*26 "	2 × "	1 "	110	111½	113	114
26½ "	1 × "	1 "	105	106	107½	108½
*26½ "	1 × "	1 "	105½	107	108½	110

Sheets marked * are six feet long, all others are eight feet long.

Where different lengths of sheets are used from those shown above, there will be a slight variation in the result.

Cross Corrugated Siding.

Full Size of Sheet.	Size of Corrugation.	For Side Lap of	And 1 Inch End Lap—sq. feet.	And 1½ Inch End Lap—sq. feet.	And 2 Inches End Lap—sq. feet.
88 × 36 inches.	2½ × 5 inches.	1 corrugation.	106	107½	109
88 × 30 "	2½ × "	1 "	106½	108½	110½
66 × 36 "	2½ × "	1 "	107	108½	110
66 × 30 "	2½ × "	1 "	107½	109½	111½
83 × 36 "	2 × "	1 "	105	106½	108½
83 × 30 "	2 × "	1 "	106½	108	110
62 × 36 "	2 × "	1 "	106½	108	109½
62 × 30 "	2 × "	1 "	107½	109½	111½

To Find the Quantity Necessary to Cover a Square.

IN order to find the quantity of Corrugated Iron necessary to **cover** any given sized space, **multiply** the number of squares of surface to be covered by the number of square feet, as shown in table on page 79, depending on what lap it is intended to give, and **divide** the result by one hundred, which will give the number of squares, as sold, necessary to do the work.

FOR EXAMPLE:

A roof, 40×60 feet, is to be covered with $2\frac{1}{2} \times \frac{5}{8}$ -inch corrugated sheets, 96×33 inches, and it is desired to give the iron four inches lap at the ends of sheets, and two corrugations side lap; 40×60 feet = 2400 square feet, or 24 squares of surface to be covered. By a reference to the table it will be seen that it will require $125\frac{1}{3}$ square feet of corrugated iron to cover each square of surface, when laid allowing for these laps. $24 \times 125\frac{1}{3} = 3005$ square feet or $30\frac{5}{100}$ squares, as sold, to cover the roof.

How to Order Corrugated Sheets.

FOLLOW directions previously given, and estimate just what quantity will be required, allowing for laps, or, if preferred, customers may send us size of surface to be covered, stating **what amount of lap** is to be given at both sides and ends of sheets, and we will send the correct quantity.

It sometimes happens that there is a small amount of waste, on account of the standard length of sheets not working out exactly for each particular job, but this can be readily allowed for by dividing the length of the rafter or the height of the wall by the standard length of the sheet, not forgetting, however, to allow for the end laps. As a rule, the standard lengths will be found to work out, or will cut into equal parts to advantage without waste.

When so ordered, sheets will be cut to exact size required, in which case we charge for the actual time taken in cutting, and also for any waste there may be.

In ordering always be careful to mention the size of sheet wanted, whether painted or galvanized, size of corrugation and gauge. A little attention in this direction will avoid any mistakes and save any delay in making shipment.

Any size of sheet up to ten feet in length, in any gauge, can be furnished to order, but orders for special sizes or heavy gauges should always be placed at least about four weeks before material is required.

FIRE-PROOF DOORS AND SHUTTERS.



THIS shutter or door is made from **two thicknesses of thoroughly seasoned wood**, laid in opposite directions, and fastened together with clinched nails at close intervals, so as to prevent any warping, and then covered on **both sides and edges**, first with a layer of asbestos paper and then with prime charcoal tin in small sheets, locked together on all four sides in such a manner as to cover up all nail heads. The metal projects an inch over the wood at the sides and top, and the shutters are rabbetted where they join in the centre, so that they fit together closely. This form of door and shutter is the **standard adopted by the insurance underwriters**, and experience has shown that it is a better protection and will withstand far greater heat than a solid iron door. The wood filling may char, but the door will not burn even in the hottest conflagration.

The fastenings are of $1\frac{1}{2}$ -inch \times $\frac{1}{4}$ -inch bar iron, bolted through the shutter, and shutters are supplied either with or without them.

When ordering fire-proof doors or shutters, **always send a diagram**, showing the exact height and width of opening in feet and inches, and if the opening has a circular head, send distance from the bottom up to the crown of the arch, and also distance from the bottom up to where the circle starts.

We furnish shutters either with or without fastenings, and suitable hinges and eyes, all complete.

Prices quoted on receipt of specification showing shape, size and number of shutters required.

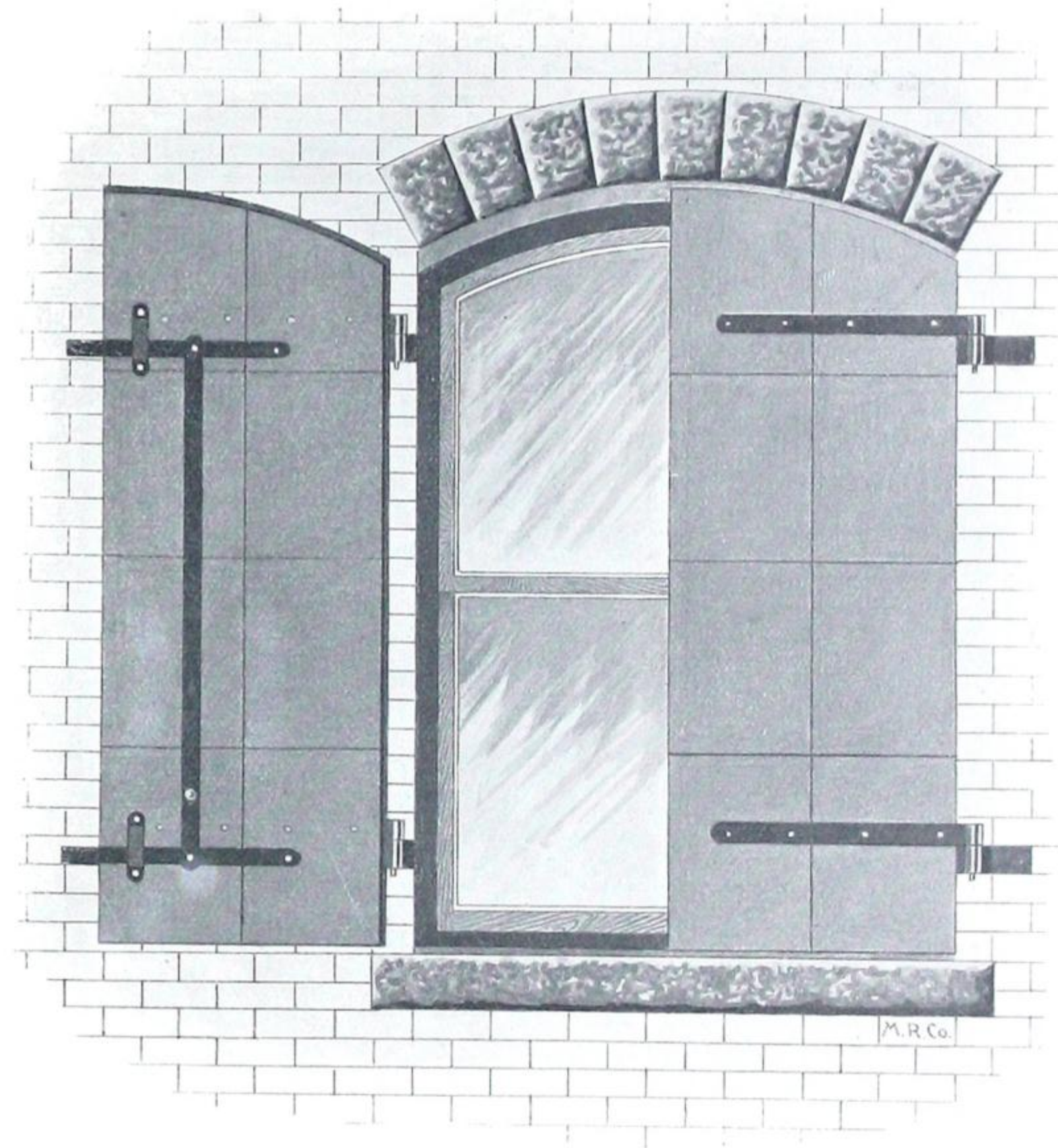

Fig. 134.

The above Illustration shows our Wood Filled Shutter, Complete with Fastenings.

Corrugated Iron Shutters.

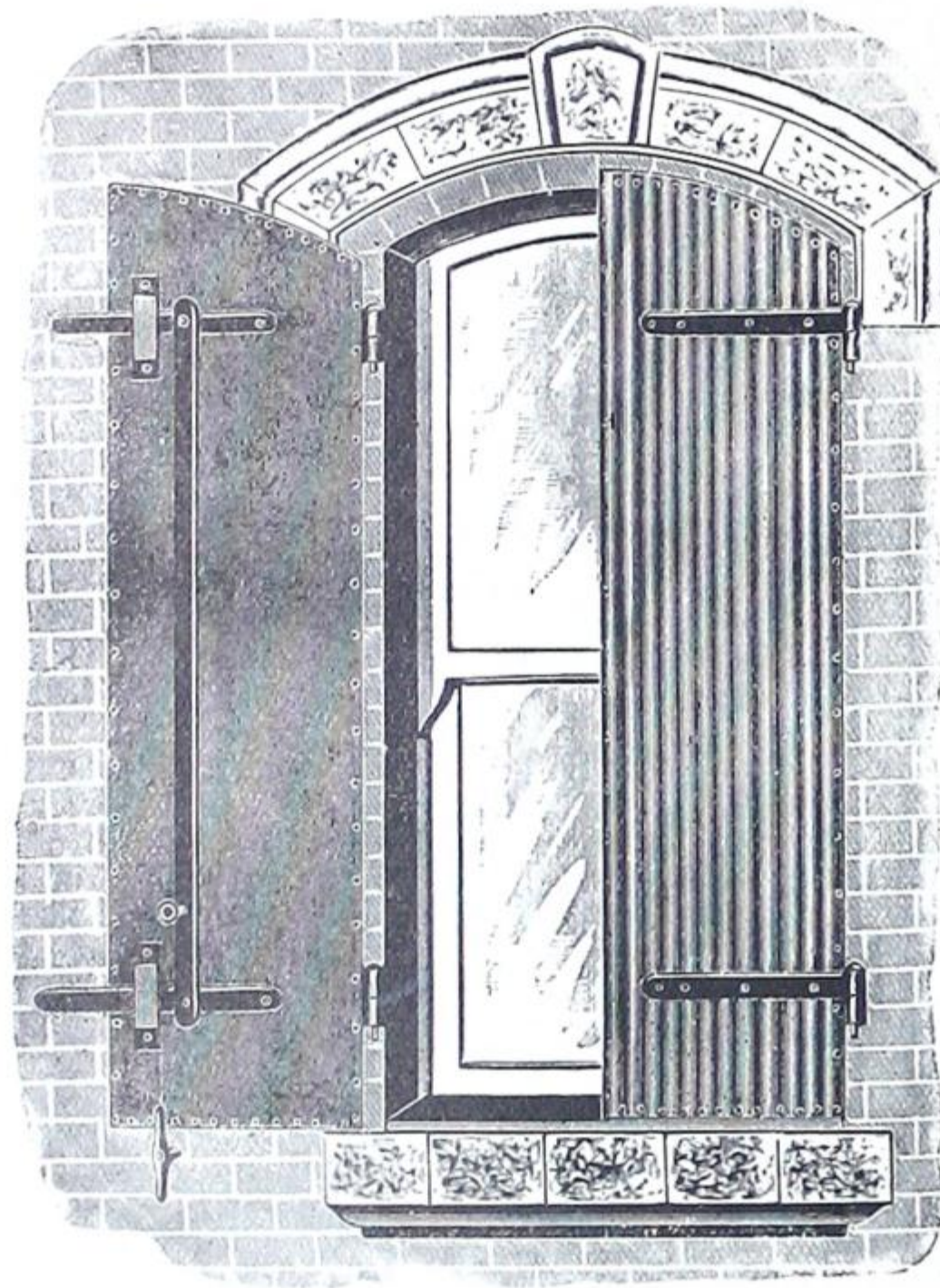

Fig. 135.



CROSS SECTION.

Fig. 136.

THE accompanying illustration shows our **Corrugated Iron Shutter** as it appears on the building, with a cross section of same showing the way it is put together. It consists of a sheet of corrugated iron (1, 2, or 2½-inch corrugations), and a sheet of flat iron, joined and rivetted together in every corrugation at the ends, and every three inches at the sides. The space between the corrugated and flat sheets **forms an air chamber** which prevents the shutter heating through and warping in case of fire.

The shutters are made with flanges where they join together in the centre, and one fits over the other tightly.

The fastenings are of 1½-inch × ¼-inch bar iron, bolted through the shutter, and shutters are supplied either with or without them.

When ordering fire-proof doors or shutters, **always send a diagram**, showing the exact height and width of opening in feet and inches, and if the opening has a circular head, send distance from the bottom up to the crown of the arch, and also distance from the bottom up to where the circle starts.

We furnish shutters either with or without fastenings, and suitable hinges and eyes, all complete.

Prices quoted on receipt of specification showing shape, size and number of shutters required.

THE METALLIC ROOFING COMPANY OF CANADA, LIMITED, TORONTO, CANADA.

“Richardson’s” Pressed Metal Fire-Proof Doors.

Duplex Copper Plated.

The only absolutely Fire-proof Door made suitable to use in first-class buildings. Recommended and endorsed by leading architects, and fully complying with insurance underwriters’ specifications for standard fire-proof doors.

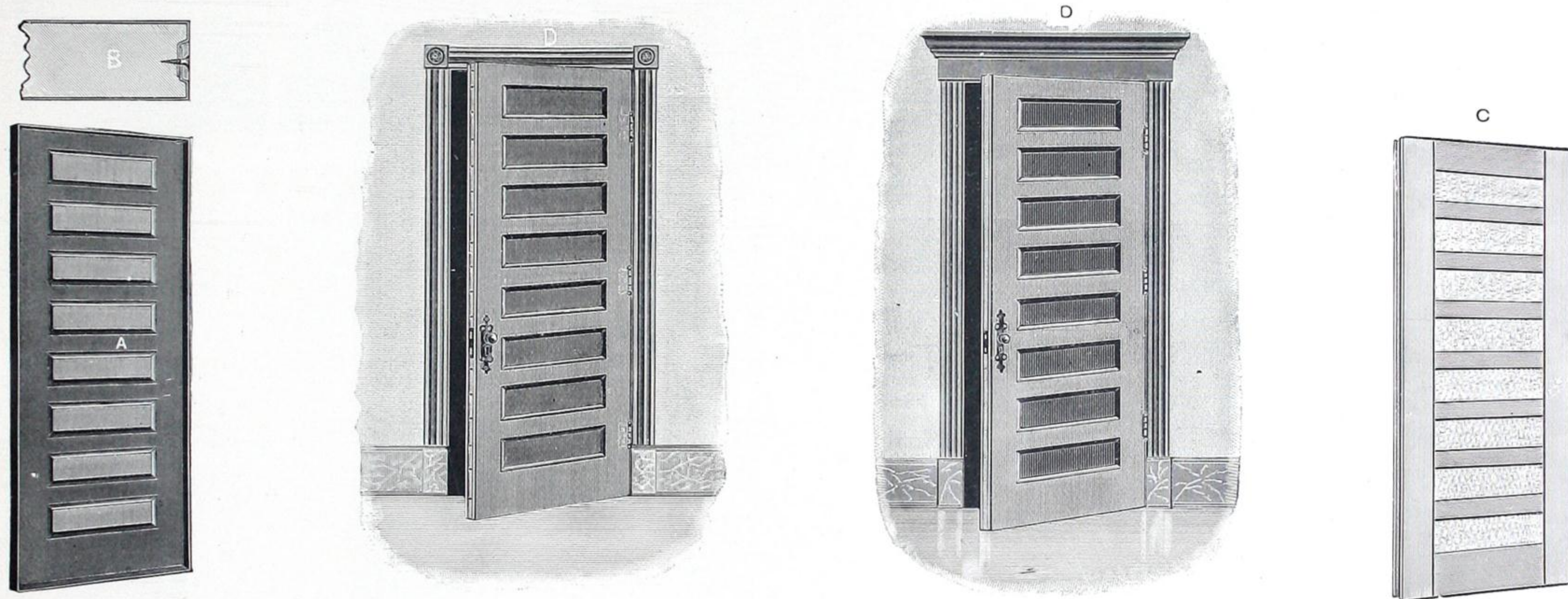

Fig. 137.

- A—Represents the sheet of steel for one side of the door, with the panels pressed in and the edges turned down to fit over the wood core.
- B—Represents the method of fastening the steel sides to the wood core; the edges of both sheets of steel are pressed into the groove in the wood core, lapping each other; the groove is then filled with a steel band extending all around the door; the screws go through the band and both sheets of steel, absolutely binding them in place.
- C—Represents the wood core, which is made the desired size from three thicknesses of wood, laid in opposite directions; this is protected from the metal by fire-proof paper.
- DD—Represents the door, jamb and casings put in complete, making a rich, handsome and fire-proof opening.

Note the method of fastening the steel sides to wood core, as shown in B.

Each side pressed from one single sheet of metal.

Fire-Proof Doors.

“As broad as it is long.” A fire-proof door is not intended for a wood partition, neither is a wood door intended for a fire-proof partition, is it?

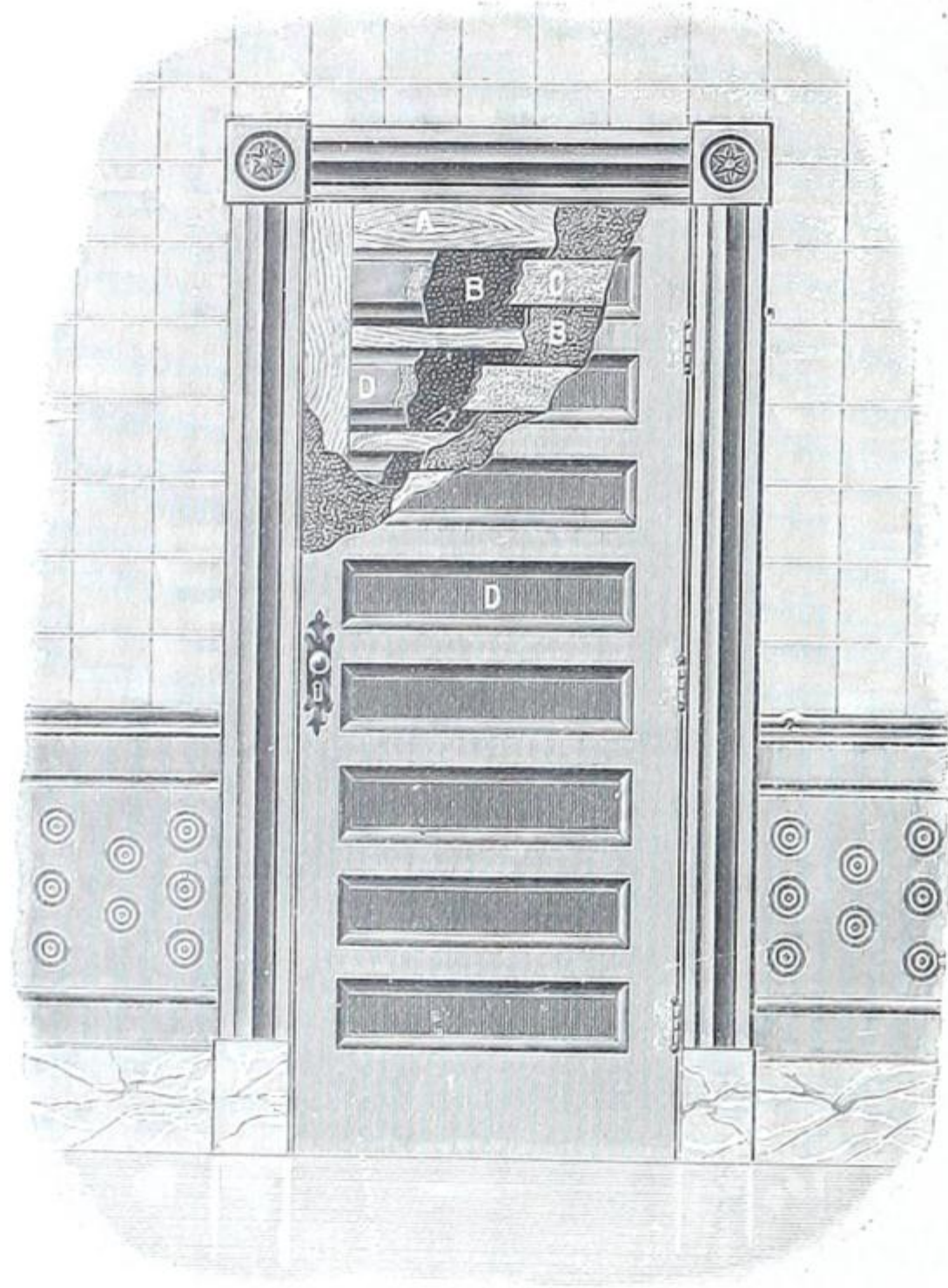

Fig. 138.

Detail Construction of Door.

A—Wood core. C—Asbestos paper on back of each panel.
 BB—Salamander paper. DD—Steel sides.

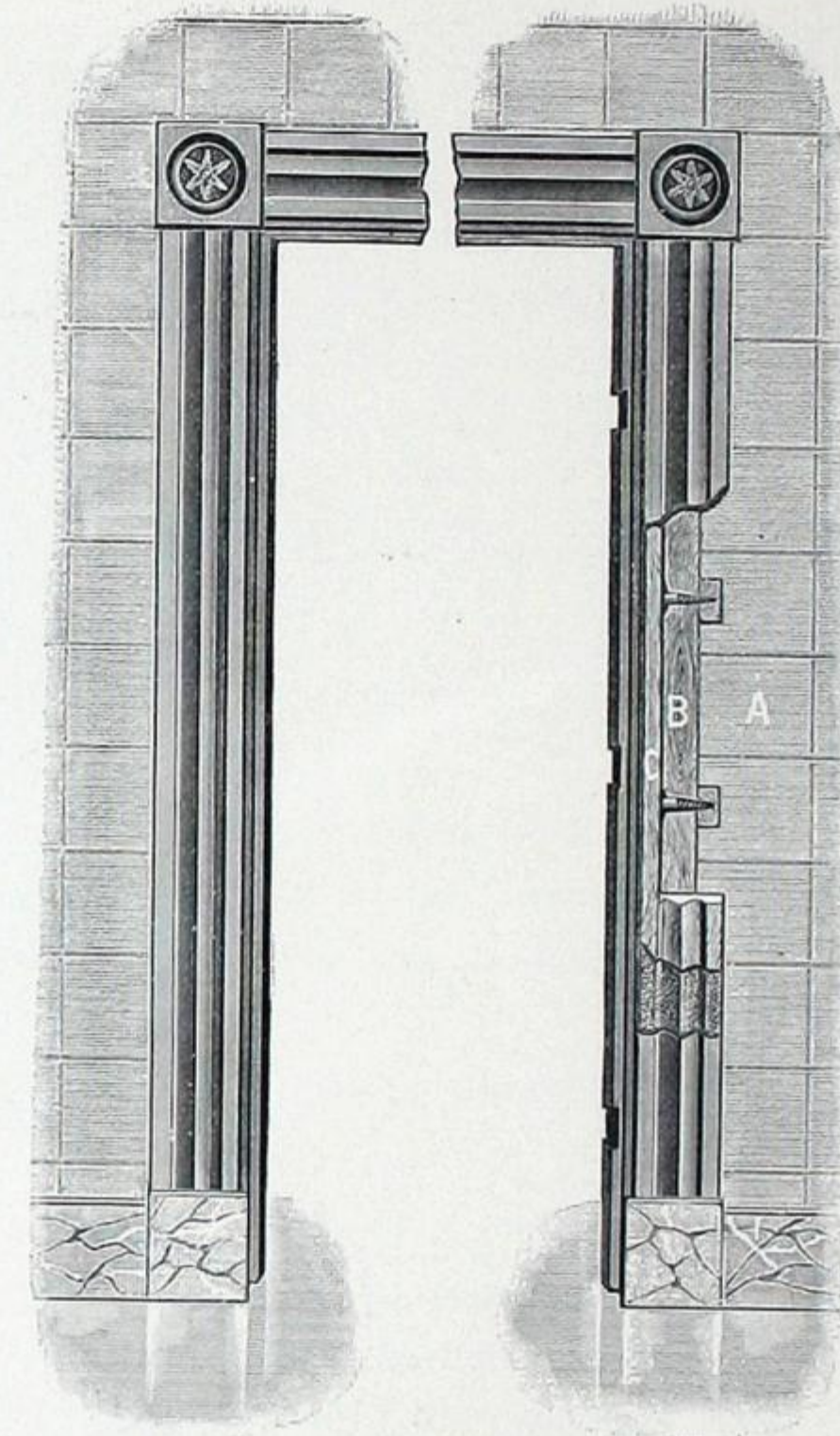
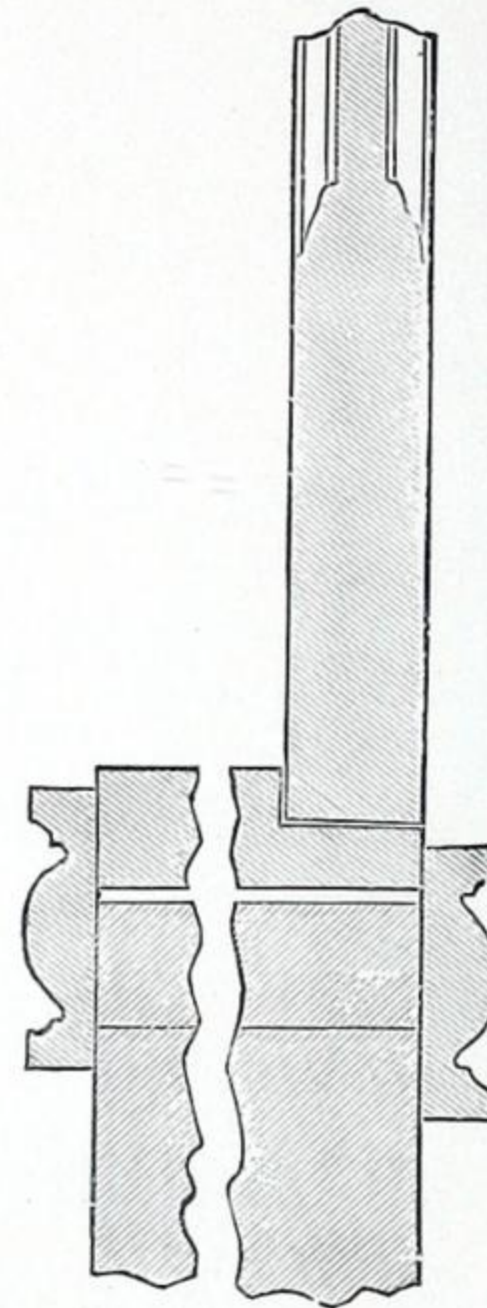

Fig. 139.

Detail of Putting in Building.

A—Tile on metal lath partition. C—Metal-covered jamb.
 B—Rough frame. D—Metal-covered casing.

Fire-Proof Doors.

OUR DOORS.

OUR DOORS are fire-proof. They will confine the fire to any one room.

OUR DOORS are handsome, being Plated Duplex Copper, and then finished up in Bronze, Old Copper, Antique, etc. They always remain the same.

OUR DOORS cannot warp, shrink, sag or swell. They have NO joints to pull apart.

OUR DOORS are made of two sheets of steel, one on each side of the wood core. The panels are pressed in without wrinkles or cutting.

OUR DOORS are not high priced; while we have the BEST door ever made, we only ask a reasonable price for them.

OUR DOORS should be used in all fire-proof buildings, to make them fire-proof.

OUR DOORS are a substitute for hardwood doors, and especially adapted for use all through Hotels, Hospitals, Asylums, Court Houses, Post Offices, Office and Bank Buildings, Theatres, Libraries, etc., etc.

OUR DOORS used for Office Vaults are cheaper and more fire-proof than the heavy solid iron doors.

OUR DOORS give tone and character to a building, and the public can SEE the evidence of fire-proof construction—"seeing is believing."

OUR DOORS will save you insurance and bring you higher rentals.

OUR DOORS will prove the best investment you can make.

OUR DOORS are no heavier than a hardwood door.

DIES, CASINGS, HINGES AND LOCKS.

Where special designs are required, on large orders we will build one die to the architect's detail for every five hundred doors, without extra charge. Where two dies are required on a five hundred door order, price will be raised \$1.00 per door.

Casings will be built to architect's detail on all orders of one hundred doors, without extra charge. Almost any design in wood can be duplicated.

Hinges set on the face of the doors, so they can be bolted through them, may be used if desired, or the common style butt, same as on a wood door, is what is generally used.

Any style lock can be used; the only requirement is that the face of it shall be same width as band of steel around the door. Locks should be put in when door is made.

DON'TS.

DON'T think you know all about these doors until you have seen them, because they are different from any door you have ever seen.

DON'T condemn the door because it's New—plenty of things that are new are good.

DON'T use any more wood doors in a fire-proof building—your building is not fire-proof if you do so.

DON'T hesitate to investigate the merits and beauty of these Doors, Jambs, Casings and Wainscoting. It will cost you nothing to do so, and your inquiries will receive prompt and careful attention.

DON'T think the doors are heavy, because they are not.

DON'T figure our doors against just the plain hardwood doors right out of the shop. Figure them finished, oiled, fitted and hung.

DON'T think this door is not fire-proof, because it IS. It has been TESTED.

DON'T spend thousands of dollars for other fire-proof materials, and then destroy their value by using wood doors to carry the fire from one room to another.

DON'T think steel constructed buildings, when filled with wood doors, jambs and casings, will not burn, because they will. The Manhattan Savings Bank Building, also the Home Insurance Building, both of New York, were of steel construction, yet were completely gutted by fire, catching from a building across the street. (See pages 99 and 100.) OUR DOORS, ETC., WOULD HAVE PREVENTED THIS.

ORDERING AND PRICES.

In ordering or asking for prices, we require to know the number of doors required, the exact size of the opening, which way the doors swing, the thickness of the partition, if casings are wanted for one or both sides of the opening, if hinges are wanted and kind of same, and style of lock required. Clear and explicit instructions on each point are necessary.

Fire-Proof Doors.

Sizes and Measurements of Standard Fire-Proof Doors.

(See also page 87.)

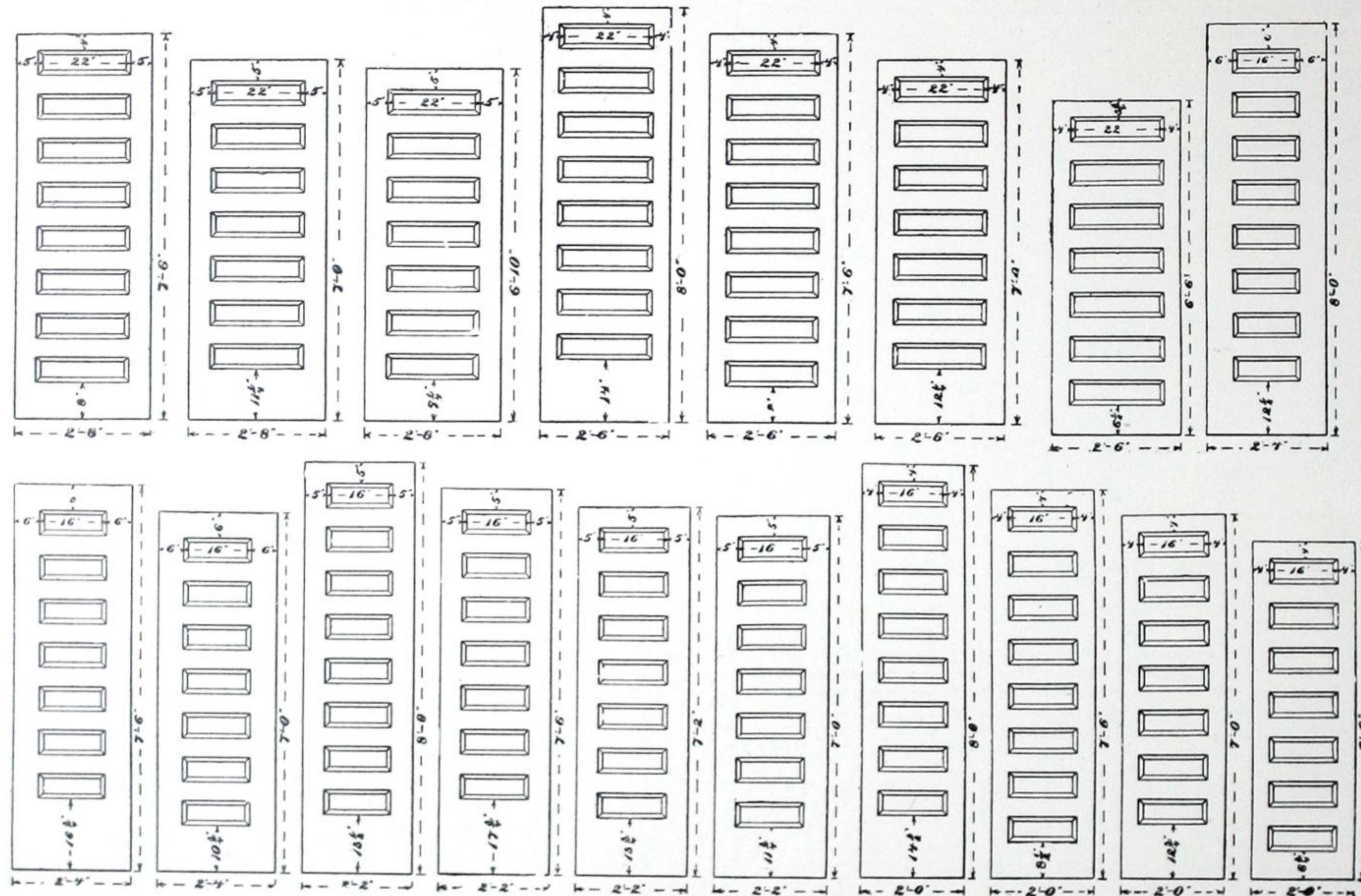

Fig. 140.

Fire-Proof Doors.

Sizes and Measurements of Standard Fire-Proof Doors.

(See also page 86.)

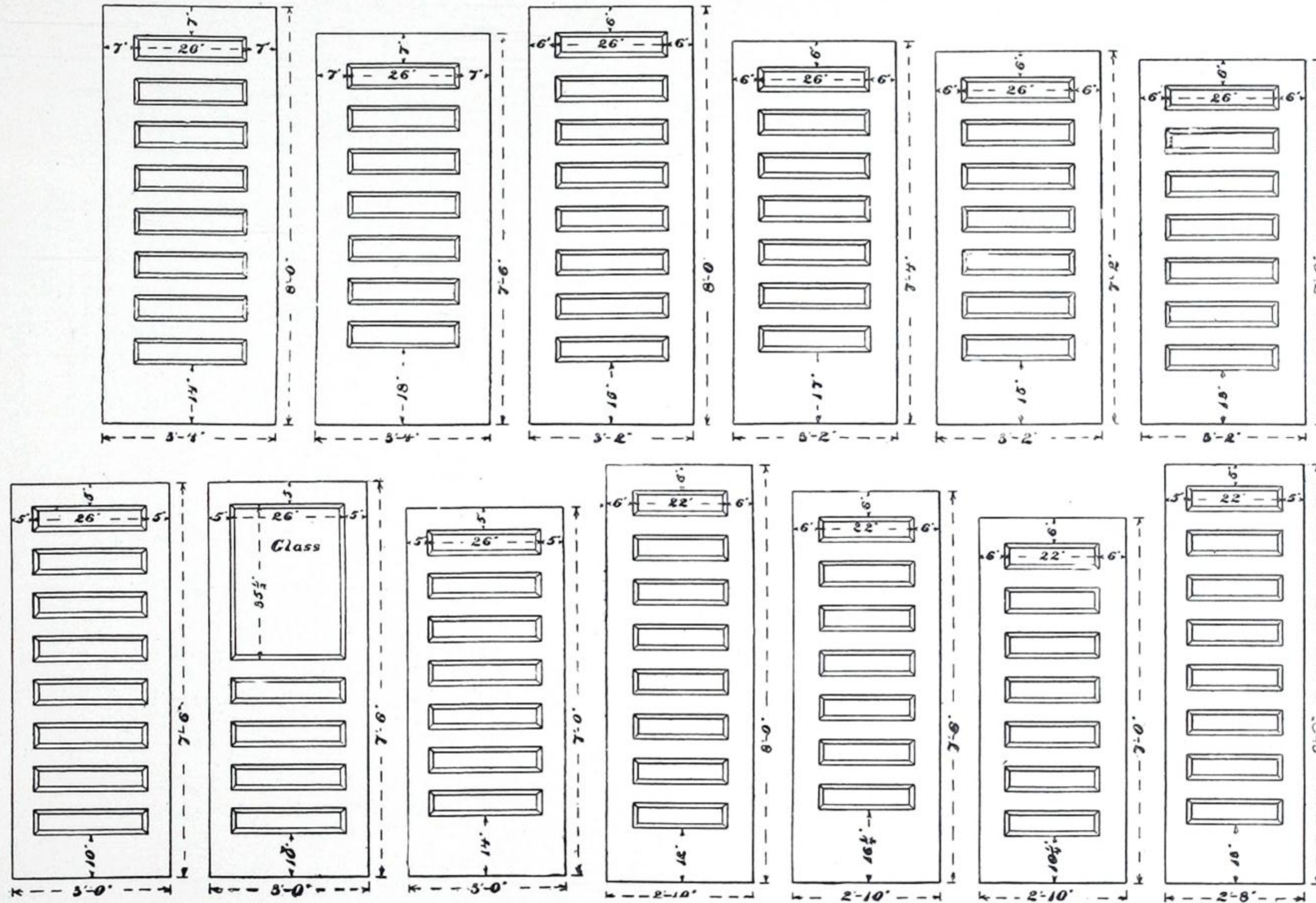

Fig. 141.

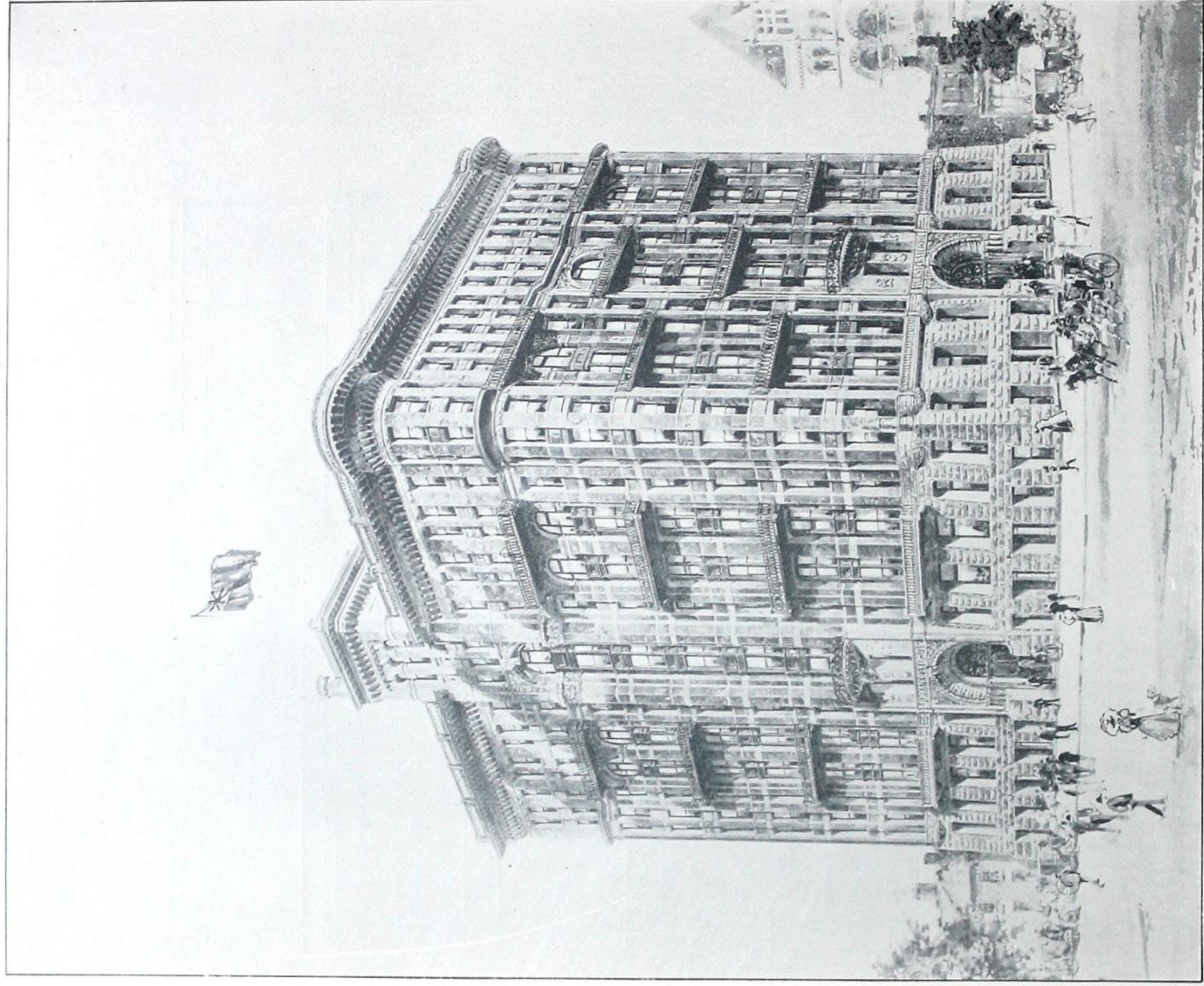

Fig. 142.—The "Temple Building," Toronto.

(10 STORIES HIGH.)

GEO. W. GOUINLOCK, Architect.

The Home of the

"INDEPENDENT ORDER OF FORESTERS."

An absolutely fire-proof structure. Finished throughout with "Richardson's" Pressed Metal Fire-proof Doors (nearly 500), Metal Covered Jambs, Casings, Wainscoting, Window Trim (over 1,000 windows), and the "Hayes" Patent Steel Lathing. About \$45,000 worth of our goods used in this building.

(See next page.)

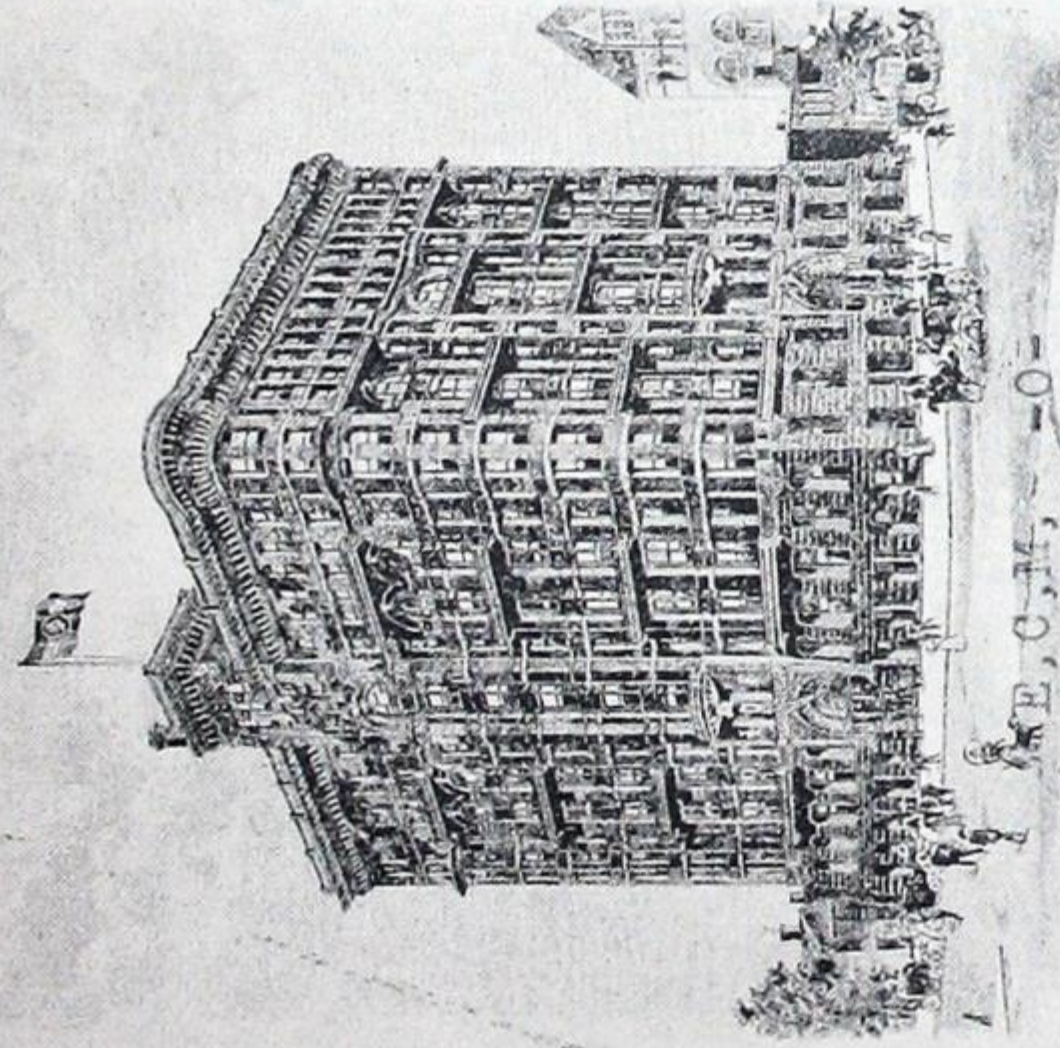

THE HEAD OFFICE OF I.O.F.

Messrs The Metallic Roofing Co.,
Corner King and Dufferin Sts.,
Toronto.

Gentlemen:

I have great pleasure in certifying that the steel fire proof doors, and door and window trims, as well as the wainscot- ing put into the Temple Building, Toronto, have proved eminently satisfactory. They are universally admired for their artistic construction and finish, and are highly commended by representa- tives of insurance companies. We anticipate a very considerable reduction in the rate of the premiums charged us by such companies by reason of your steel fire proof doors. It seems to me they are a sine qua non in every thoroughly fire proof building such as the Temple Building.

Yours sincerely,

Boulbyatetha
S.C.R.

ASSESSMENT

THE EXECUTIVE COUNCIL

ORONIHATZKA, M.D. TORONTO, ONT.
SUPREME CHIEF RANGER

E. BOTTELLE, HOUSE W. COMMONS, OTTAWA,
PAST SUPREME CHIEF RANGER.

HON. D.D. AITKEN, ELINT, MICHIGAN,
SUPREME VICE CHIEF RANGER.

JOHN A. MCGILLIVRAY, C.C.M.D. TORONTO,
SUPREME SECRETARY.

H.A. COLLINS, TORONTO,
SUPREME TREASURER.

THOMAS MILLMAN, M.D. TORONTO,
SUPREME PHYSICIAN.

HON. JUDGE W. WEDDERBURN,
MONTREAL, N.B.,
SUPREME COUNSELLOR.

SYSTEM

OFFICE OF THE
EXECUTIVE COUNCIL
OF FORESTERS.

INDEPENDENT ORDER I.O.F.

CABLE ADDRESSES:
FORESTERS, TORONTO.
ORONHYA, LONDON.
MOOSE, BELFAST.

TELEPHONE 1790

OF THE SUPREME COURT.

TORONTO, CANADA.

IN YOUR REPLY

GIVE NAME & No. OF COURT
Sept. 3rd, 1897.

Fire-Proof Doors.

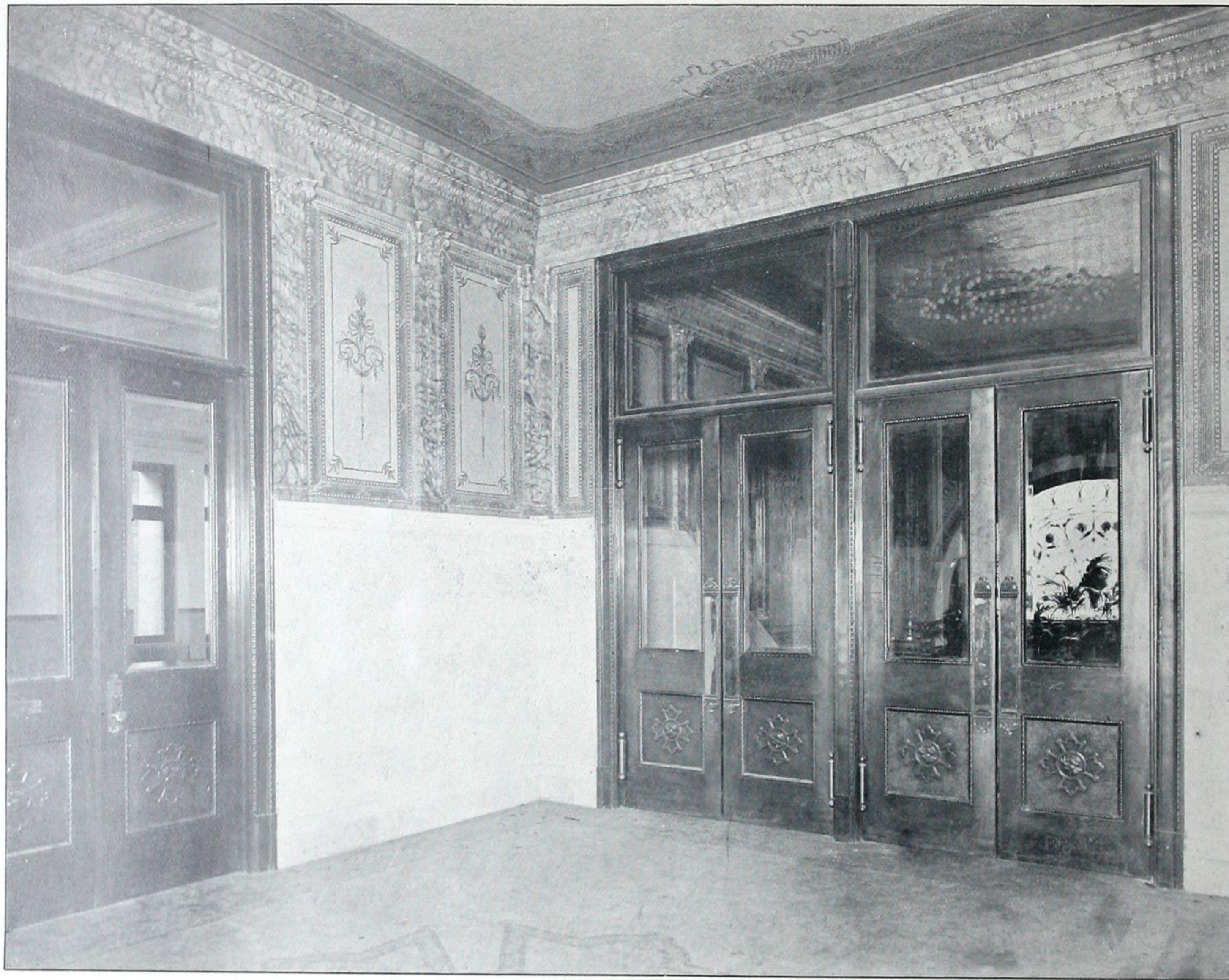

Fig. 143.—Interior View, Temple Building, Toronto.

Shows double-acting entrance doors, with transoms, casings, and plinth blocks. All duplex copper-plated steel. Reproduced from a photograph.

Fire-Proof Doors.

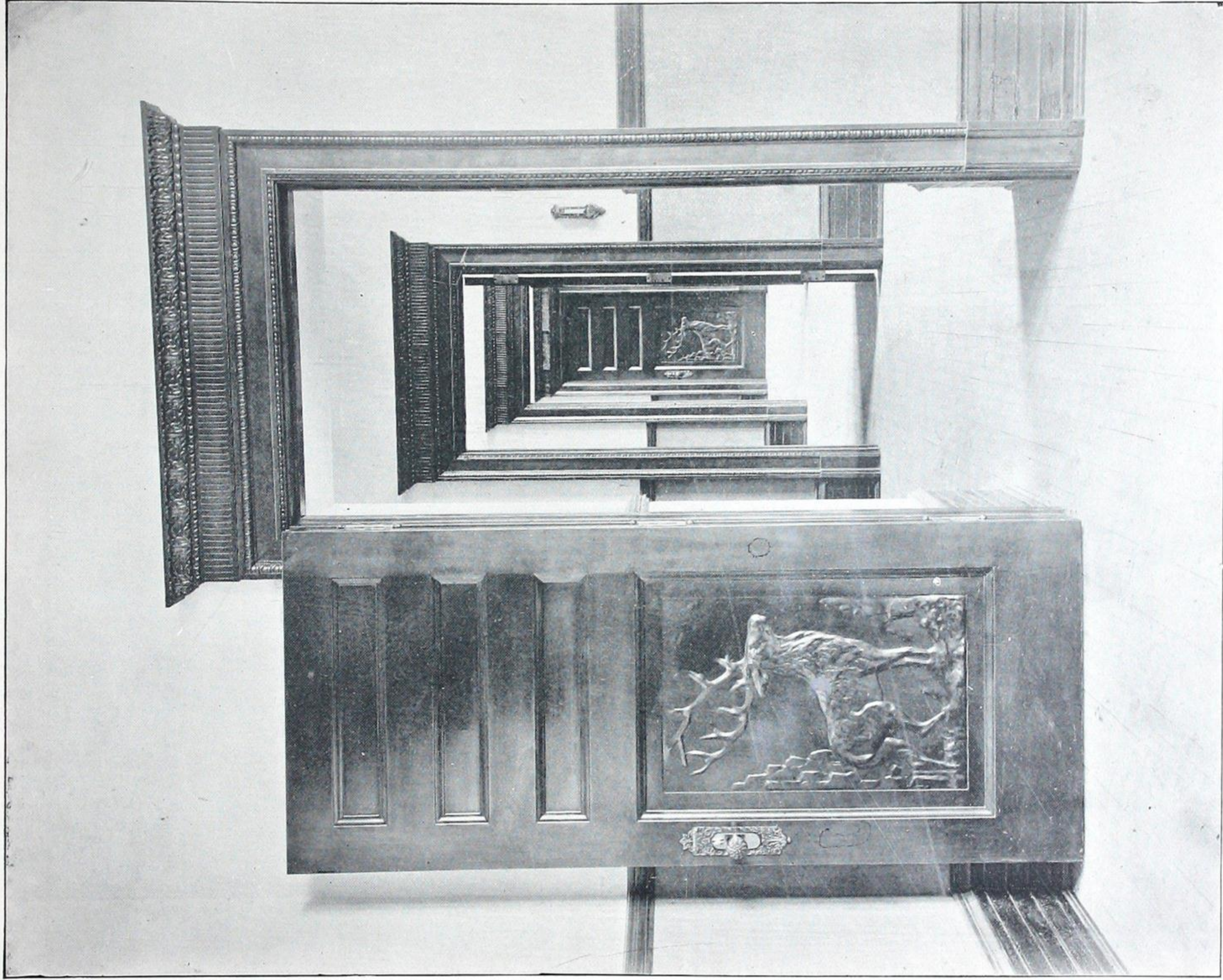

Fig. 144.—Interior View, Temple Building, Toronto.

Shows stag panel communicating doors, with casings and headers complete, also base and plinth blocks. All duplex copper-plated steel. Reproduced from a photograph.

Fire-Proof Doors.



Fig. 145.—Interior View, Temple Building, Toronto.

Shows monogram panel corridor door with glass and transom, also panelled dado and base. All duplex copper-plated steel. Reproduced from a photograph.

Fire-Proof Doors.

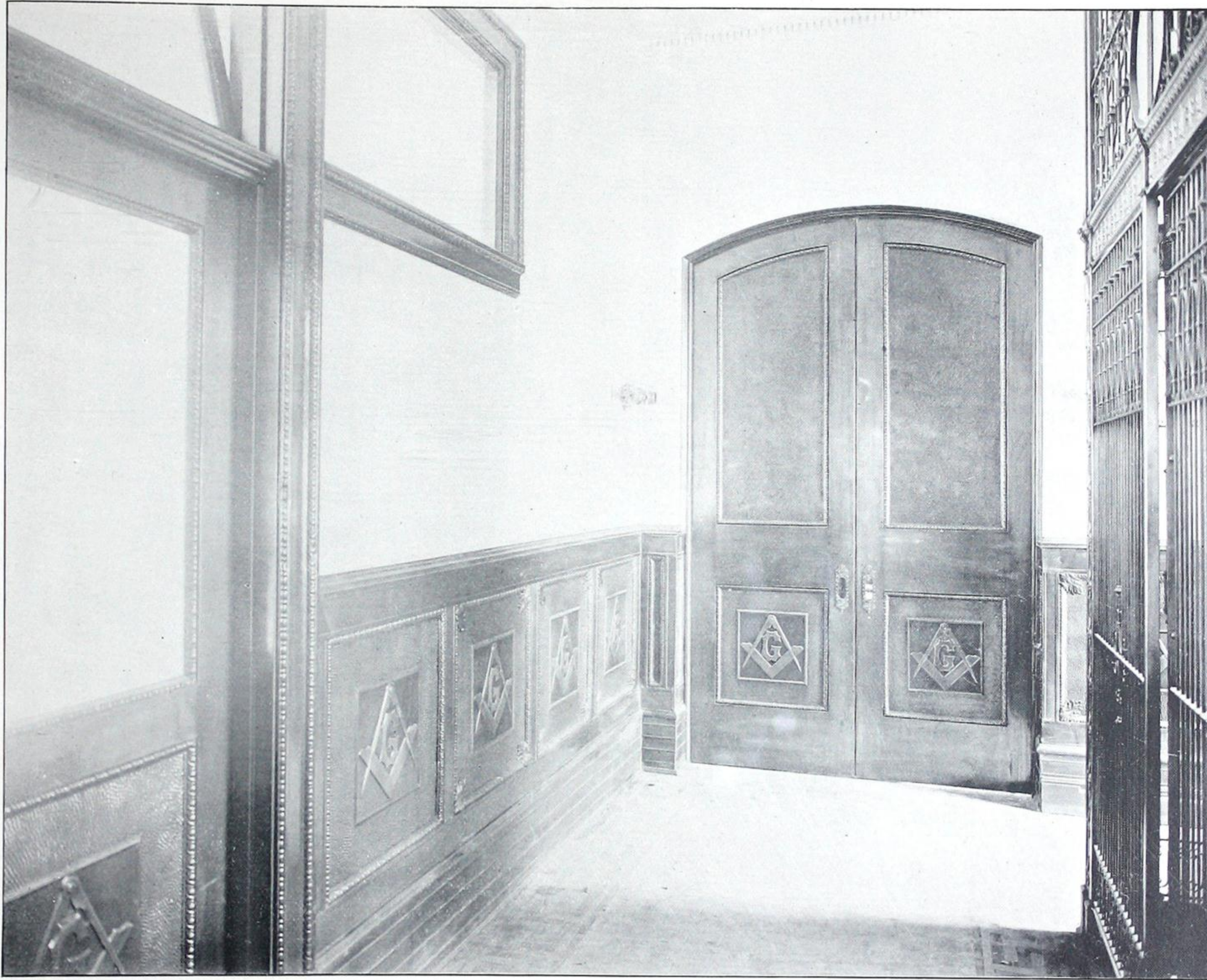

Fig. 146.—Interior View, Temple Building, Toronto.

Shows Masonic monogram sliding fire doors cutting off elevators, also Masonic monogram panelled dado, base and trim for corridor lights. All duplex copper-plated steel. Reproduced from a photograph.

Fire-Proof Doors.

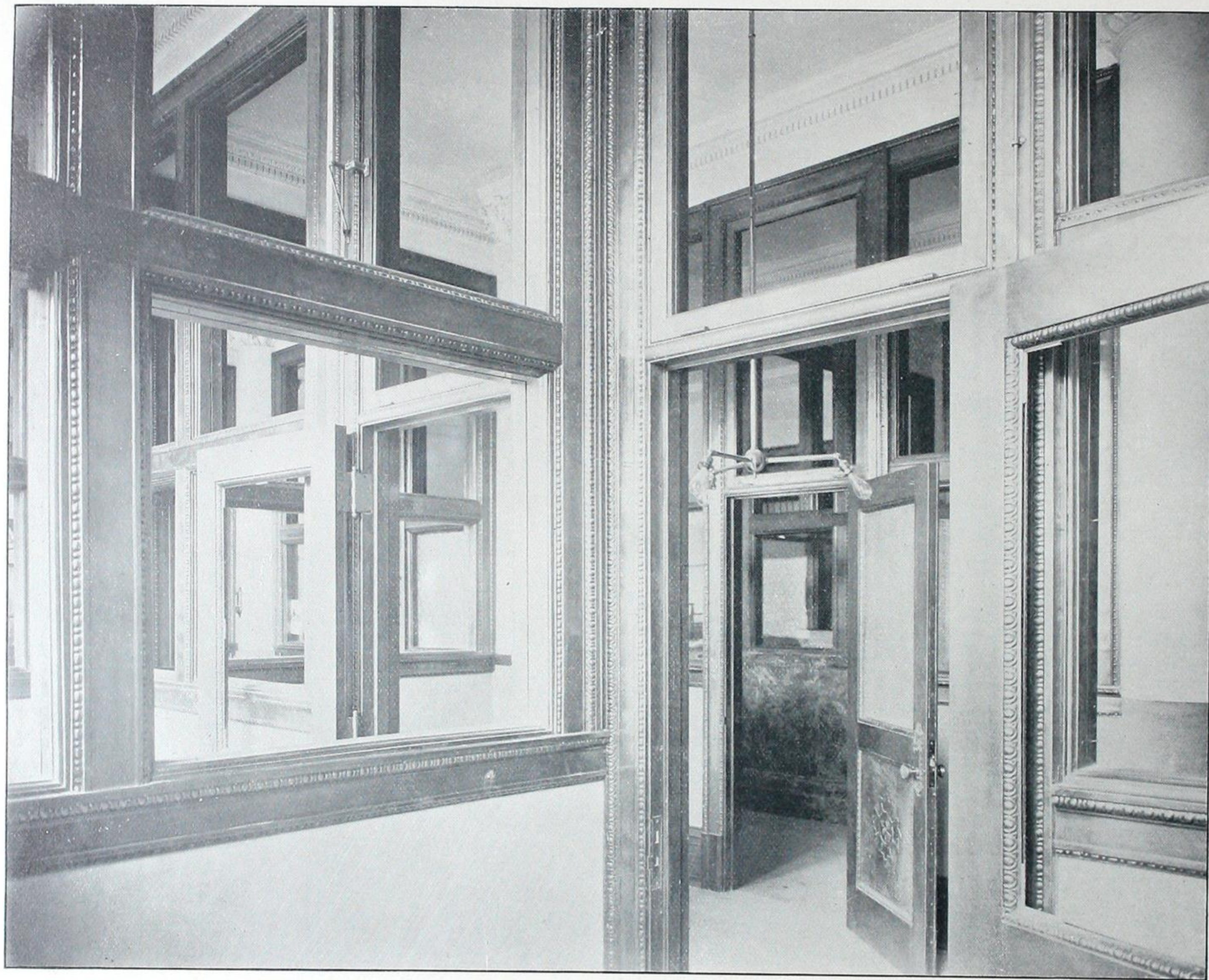

Fig. 147.—Interior View, Temple Building, Toronto.

Shows trim for inside glass partitions. All duplex copper-plated steel. Reproduced from a photograph.

Fire-Proof Doors.



Fig. 148.—Interior View, Temple Building, Toronto.

Shows monogram panelled dado and base going up the rake of a staircase. All duplex copper-plated steel. Reproduced from a photograph.

Fire-Proof Doors.



Fig. 149.—Interior View, Temple Building, Toronto.

Shows trim for exterior windows. All duplex copper-plated steel. Reproduced from a photograph.

Fire-Proof Doors.



Fig. 150.—The Y. M. C. A. Building in London,
In which our Pressed Metal Fire-Proof Doors were used.

Moore & Henry, Architects.

Fire-Proof Doors.



Fig. 151.—Parliament Building, Ottawa, Ontario.

Fire-proofed with "Richardson's" Pressed Metal Doors, and "Hayes'" Patent Metallic Lathing.

THE METALLIC ROOFING COMPANY OF CANADA, LIMITED, TORONTO, CANADA.

Fire-Proof Doors.

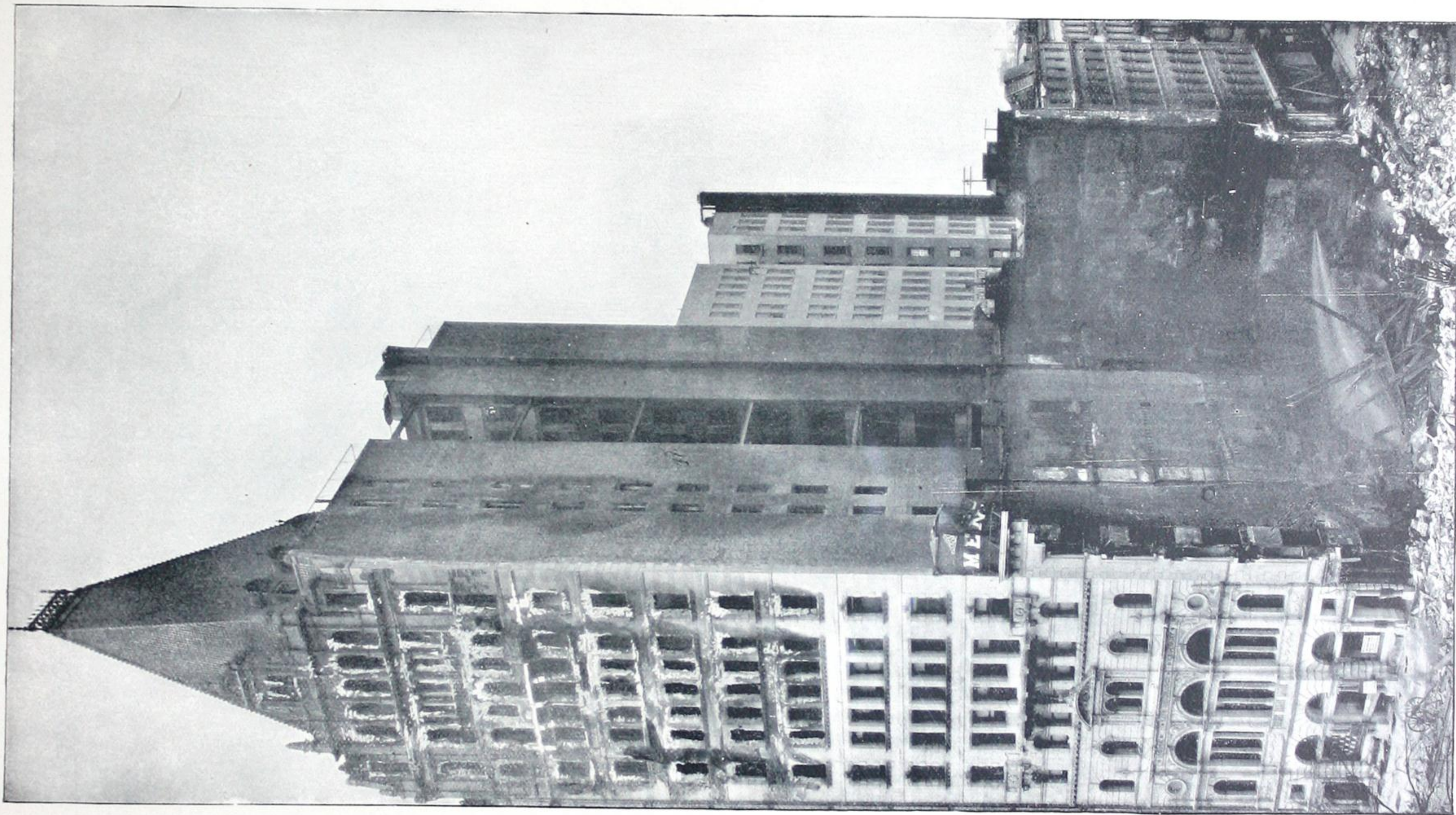

Fig. 152.—The Home Insurance Building, New York.

After the fire of December 6th, 1898, demonstrating the necessity of fire-proof interior finish.

THE METALLIC ROOFING COMPANY OF CANADA, LIMITED, TORONTO, CANADA.

Fire-Proof Doors.

SUPT. BRADY, DEPT. OF BUILDING :

"The building was as fire-proof as it is possible to make it unless the floors are cement and the doors and window frames iron."—*New York Journal*, December 6, 1898.

CHIEF BONNER, OF NEW YORK FIRE DEPARTMENT :

"In any building where the finishings are wood, and the contents—merchandise or furnishings—combustible, you will have a fire."—*New York Sun*, February 12, 1898, after destruction of Nassau and Vanderbilt Buildings.

OFFICE OF
CHIEF ENGINEER FIRE DEPARTMENT,
MINNEAPOLIS.

MINNEAPOLIS, MINN., December 6th, 1895.

GENTLEMEN,—On October 28th last I witnessed a very severe test of your fire-proof door, during which it was subjected to a heat much greater than is found in buildings on fire. Although the heat on the inside of the furnace was extremely great, at no time was there the slightest heat noticeable on the outside, it being cold to the touch. This test lasted over an hour, at the end of which time the door was found to be in good condition. I believe this to be a perfect door for the purpose for which it was intended, and strongly recommend its use wherever such an appliance is needed.

Yours truly,

F. L. STETSON,
Chief Engineer Fire Department.

Secretary McCuaig, of the Toronto Board of Fire Underwriters, to-day spoke concerning the fire as follows :

"The fire fiend was satirically aggressive when it licked the windows of the fifth floor offices of the underwriters. Some people have been saying right along that there is no conflagration hazard in Toronto, yet it seemed for a while yesterday as though we would hardly be able to save our resolutions or reduced insurance rates from that very hazard. We swallowed the conflagration hazard extra, and then the conflagration hazard nearly swallowed us. It was a costly blaze, but it had its lessons, some of which are very valuable. Take for instance, the condition of the great helpless Board of Trade building, with its unprotected windows gaping out upon the flames and without a drop of water to quench the burning embers that sizzled on its sills. **What argument for fire-proof shutters and stand-pipe and hose could be more convincing? You would think after such an object lesson we would see fire shutters on every endangered window in the business district of the city.**"—*Toronto Evening Telegram*, February 11, 1899, after Gowans, Kent & Co.'s fire.



Fig. 153.

Interior view, after the fire, in the Home Insurance Building, New York. A Practical Object Lesson.

THE METALLIC ROOFING COMPANY OF CANADA, LIMITED, TORONTO, CANADA.

Fire-Proof Doors.

R. W. GIBSON,
Architect.

18 WALL STREET,
NEW YORK, October 22nd, 1896.

DEAR SIRS,—Your enquiry is duly received asking my opinion of fire-proof doors in office buildings.

For some time past I have been profoundly impressed with the necessity of making fire-proof buildings safer against fire by the use of less wood work. Although the correctness of this principle is always admitted, yet, in practice, combustible finishing is used, under the impression that with fire-proof floors the burning of the finish is not likely to cause much fire.

Recently a small fire, in the fire-proof office building in which I have my offices, developed such intense heat from the combustion of furniture and usual wood finish of windows and doors and jambs that it completely burnt out three or four rooms; and, although the building was not in danger, the fire caused a great deal of smoke and trouble, and consequently, damage; and furnished me with a valuable object lesson.

I was confirmed in my opinion that a fire-proof office building ought to have fire-proof doors at least, and that all unprotected wood trim should be omitted if possible, in order to make a building practically fire-proof.

For these reasons I have recommended to the Onondaga County Savings Bank, for their new office building, at Syracuse, N. Y., the fire-proof door and trim sold by you as being the most practical and serviceable door I could find for such purposes, and your references from previous customers are so good that I have no doubt that our expectations will be fully realized. On this point I shall be happy to write you a letter when the doors are in use. At present I can only emphasize my opinion that high, fire-proof buildings should be equipped with something of this nature.

Yours very truly,

R. W. GIBSON.

R. W. GIBSON,
Architect.

54 BROAD STREET,
NEW YORK, July 13th, 1898.

DEAR SIRS,—I have much pleasure in replying to your enquiry as to the fire-proof doors and other work you furnished in the office building of the Onondaga County Savings Bank. They are handsome and they work well, and I am confident that their fire-proof qualities are unsurpassed. They have been in use now more than fourteen months, and are perfectly satisfactory. I shall recommend them for fire-proof office buildings at every opportunity.

Yours very truly,

R. W. GIBSON.

CLIFTON SPRINGS SANITARIUM,
CLIFTON SPRINGS, NEW YORK, September 29th, 1898.

GENTLEMEN,—In reply to your enquiry in regard to the Copper-Plated Steel Covered Doors used in our new fire-proof building, we would say, that they have been in constant use for over two years and are perfectly satisfactory.

While no occasion has arisen to test their fire-proof qualities, we feel confident of their proving efficient protection, should such necessity arise.

Yours very truly,

HENRY FOSTER.

Supt. and Treas.

FORT WAYNE, INDIANA, June 23rd, 1898.

GENTLEMEN,—When preparing plans for the Hancock County, Greenfield, Indiana Court House, since erected, it was our special care to make it a thorough fire-proof structure in its entirety, not partially so.

The fact that so little attention is paid to the character of the interior finish of otherwise fire-proof buildings, and having in remembrance the damage that has been done through the inflammable finish, led us to determine to forestall this possibility.

Appreciating the necessity of protecting especially the doors and openings, as well as the structural portions, led us to make an examination of the interior finish furnished by your Company, and upon our recommendation it was unanimously adopted by the Commissioners of Hancock County and subsequently installed in their new Court house.

Your doors, door trim and window trim have now been in place for some time and are more than satisfactory to us and the County. They afford the degree of safety desired and in appearance are superior to wood finish. The natural oak finish on part of the doors is a surprise in its perfectness, and the copper plating has proven eminently satisfactory.

We write this feeling that we want you to know how pleased we and the County are with your work, and you are at liberty to make use of this if you see fit.

We shall be glad to personally write any one desiring our opinion first hand.

Also will say, we have specified your work in another Court House which we have now in course of construction.

With best wishes for your continued success, we are

Yours very truly,

WING & MAHURIN,

Architects.

Fire-Proof Doors.

LOS ANGELES, CAL., August 18th, 1898.

GENTLEMEN,—The Homer Laughlin Building of this city is now entirely completed and partially occupied. The doors and trim look very well indeed and are proving satisfactory in every respect.

I expected that the doors, with the weight of metal upon them, would jar the light partitions in which they are hung and probably break the door and partition lights, if at any time the door should be violently closed. I am therefore pleasantly surprised to find that the doors close very gently, in fact, it is more pleasant to close them than the ordinary wood door, as a result of the sense of firmness which the weight of the door gives.

As a factor of resistance to fire, for neat appearance and durable character of the work, for fire-proof structures, I heartily endorse the system.

Very truly yours,

JOHN PARKINSON.
Architect.

MINNEAPOLIS, MINNESOTA, November 14th, 1896.

GENTLEMEN,—In answer to your enquiry as to what we think of your fire-proof doors, after having them in use in our building, the *Phoenix*, for eighteen months will say, as we have always been glad to say, that we are entirely satisfied with the doors in every respect.

They make our building fire-proof. They secure us a very low rate of insurance. They have materially aided us in renting our offices at good rentals while so many offices in the city are empty. Not a door in the building has warped, shrunken, sagged or troubled us in the least.

We cheerfully recommend your doors, jambs, casings, etc., to intending builders as the "missing link" in fire-proof construction, and we can see no reason why they will not be as well satisfied with them as we are, and we consider the money invested in your doors the best investment we made in connection with our building.

Yours very truly,

THE NEW ENGLAND ASSOCIATION,
HENRY T. PLANT, *President.*

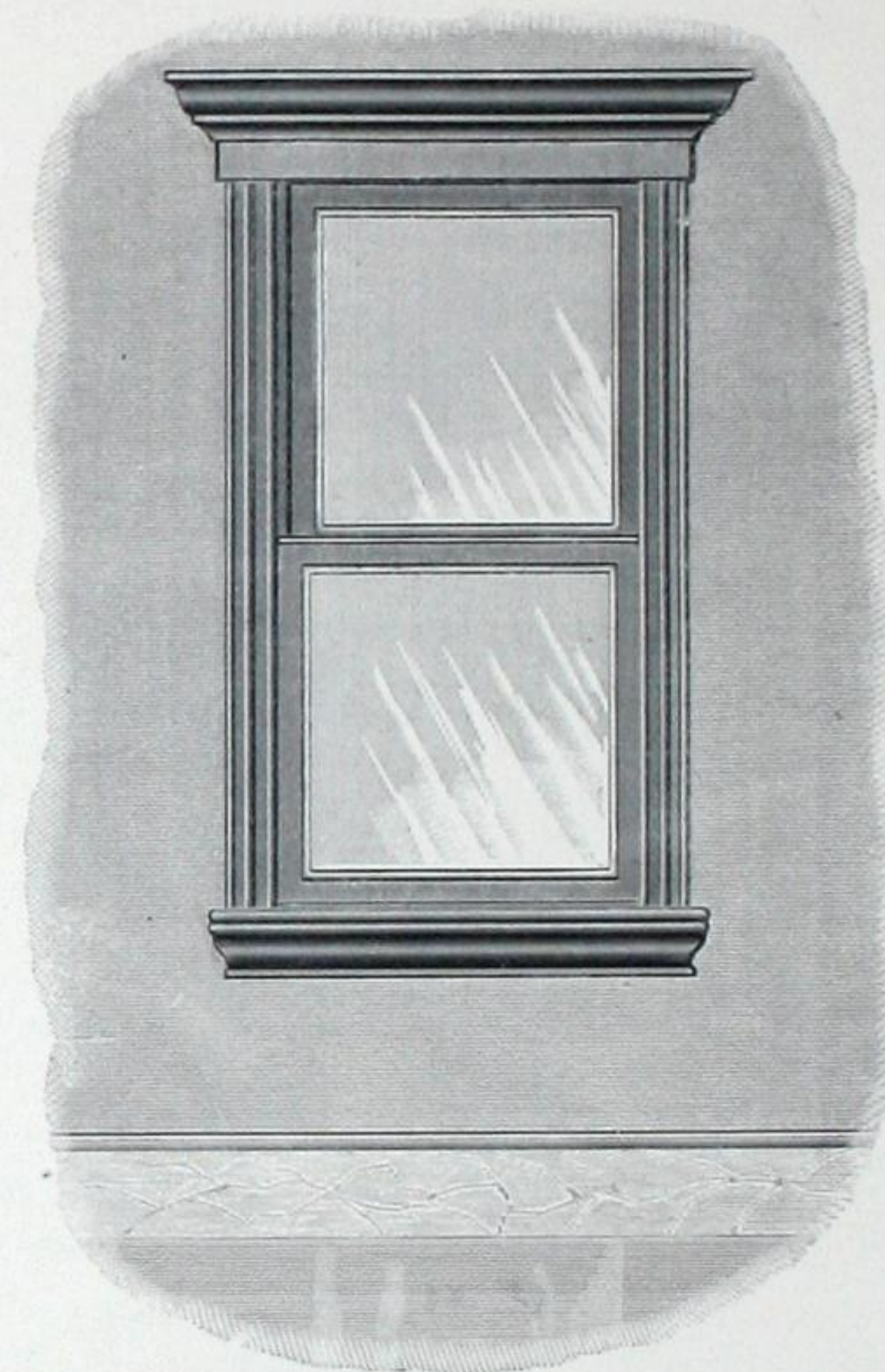

Fig. 154.

Shows Fire-Proof Trim for a window. May be made to any detail. Over one thousand windows in Temple Building, Toronto, done in this manner.

The "Metallic Roofing Co." Fire-Proof Windows.

(PATENT APPLIED FOR.)

Fire-Proof Windows, Lights in Fire-Proof Doors, Lights In Fire-Proof Elevator Shafts, and wherever Light is Required, and the Progress of Fire Retarded.

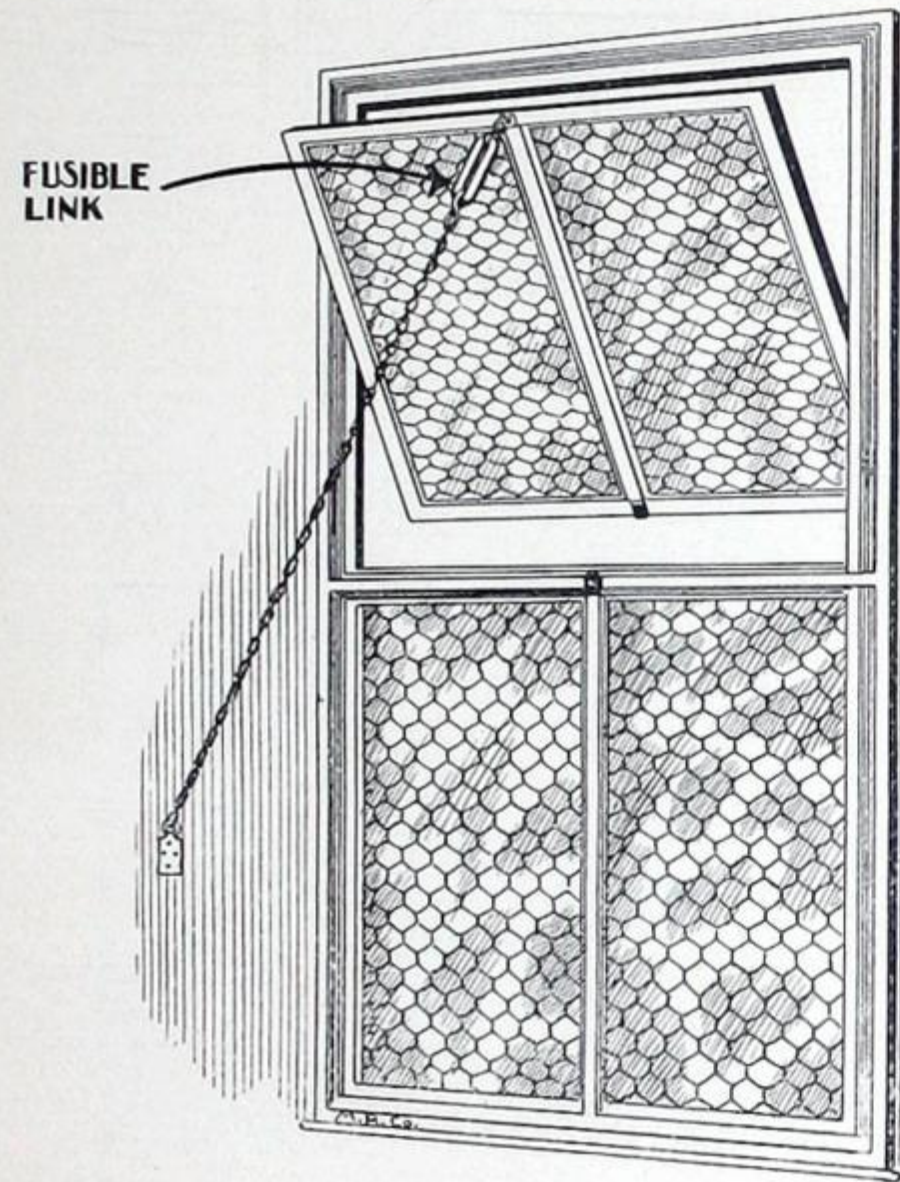

Fig. 155.

150°) the sash is instantly released and automatically closes and locks itself. This apparatus obviates the danger of any neglect in omitting to close windows, or, as might happen in a sudden conflagration, the impossibility of being able to do so; the construction of the window being such that the **automatic action of closing and locking** the window in the event of fire, **is absolutely sure and certain.**

Figs. 156, 157, 158, 159 and 160, illustrate different suggestive constructions applicable to our fire-proof windows.

FIG. 155 shows the application of our **automatic closing and locking device.** By means of this

device, when so desired for ventilation, the sashes are held open, as shown, by a chain in which is a **soft fusible link** which readily melts when subjected to the slightest heat, on the same principle as the sprinkler systems in such common use. **The moment this fusible link melts** (which is only at

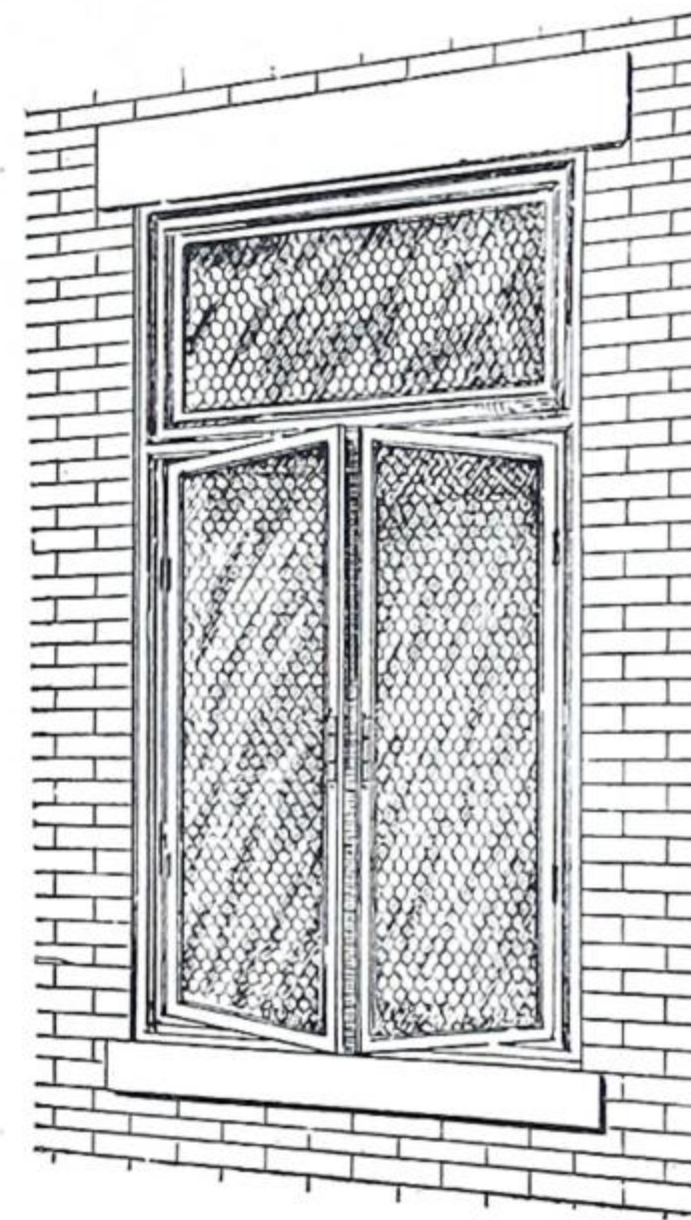

Fig. 156.

The construction of the **frames and sashes is of hollow sheet metal**, formed in such a manner as to be perfectly stiff and rigid, and **as all parts are interlocked securely, and bolted together** (the use of solder being for the purpose only of finishing the joints), **they will remain intact when subjected to fire.**

This frame is much more fire-proof than if it were made from solid iron, where the natural consequence in a great body of metal is the greater susceptibility to derangement by expansion in case of heat, this being relative to the actual quantity of metal employed, while by using a hollow bar of proper form we arrive at the result of dispensing with the amount of solid matter and preserving the original strength without its weight and liability to derangement.

It has been demonstrated by actual tests made over and over, that a solid iron bar would warp and twist out of shape, while a hollow metal bar would remain perfect, both being subjected to the same heat. The windows are made so they may be built into the brickwork as the building progresses, or they can be put in buildings already erected.

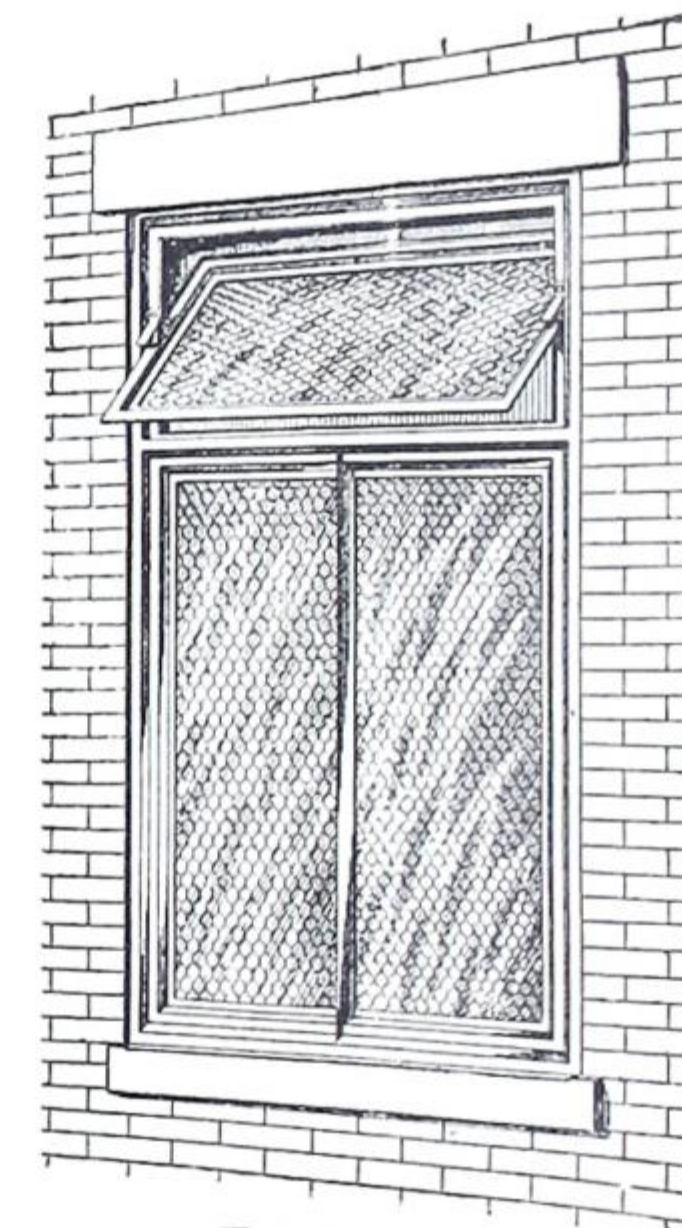

Fig. 157.

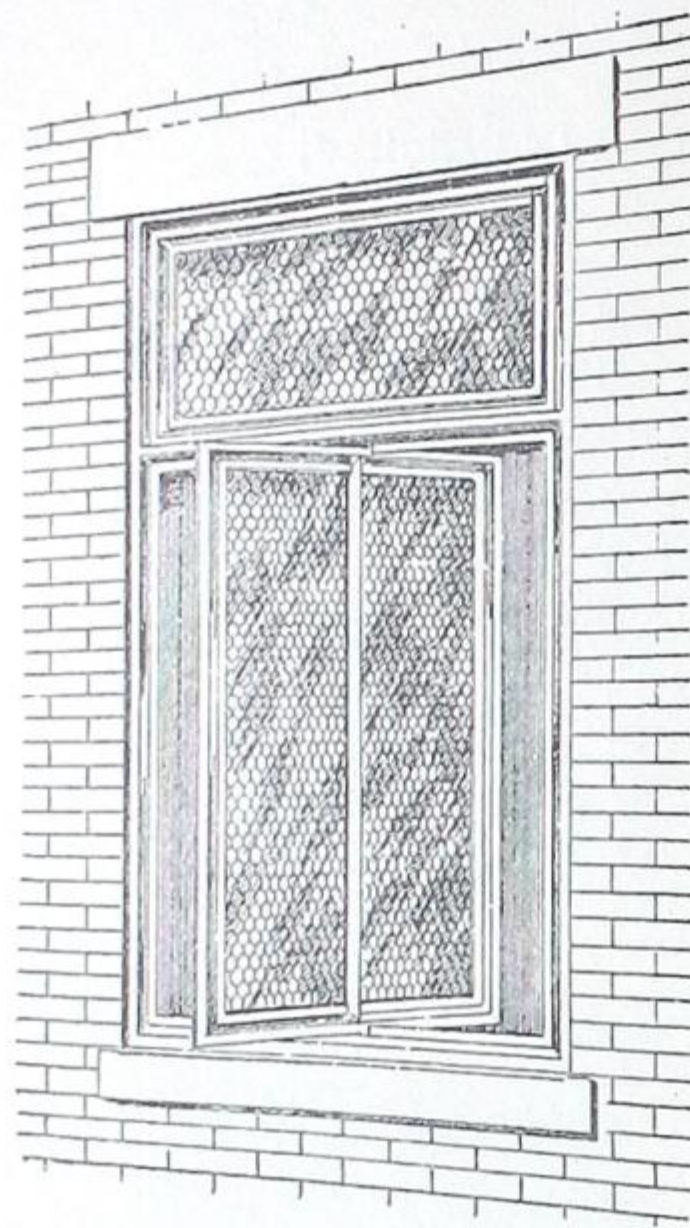

Fig. 158.

glass. The glass is securely held in the frame in such a manner that by merely inserting it in the grooves provided for that purpose, it will remain without other means, but a pocketed rebate is also provided so that the finishing of the glazing is effected by simply pointing up the joint. Asbestos or other putty may be used, but common putty is all that is necessary, as the glass does not depend on the putty at all for holding it in place.

Many practical tests of the fire-resisting efficiency of this window have been made, and they are universally endorsed by the various Boards

They are made to any form of opening or stationary sashes, hung, hinged or pivoted on the sides, or at the top and bottom.

The windows are glazed with glass $\frac{1}{4}$ -inch thick, in which wire is embedded through the centre, so that if the glass does break the wire still holds it in its place, effectually resisting intense heat and withstanding the application of water upon the heated glass, when used to extinguish fire. The diffusion of light is not retarded in the slightest, but is quite equal to ordinary plain

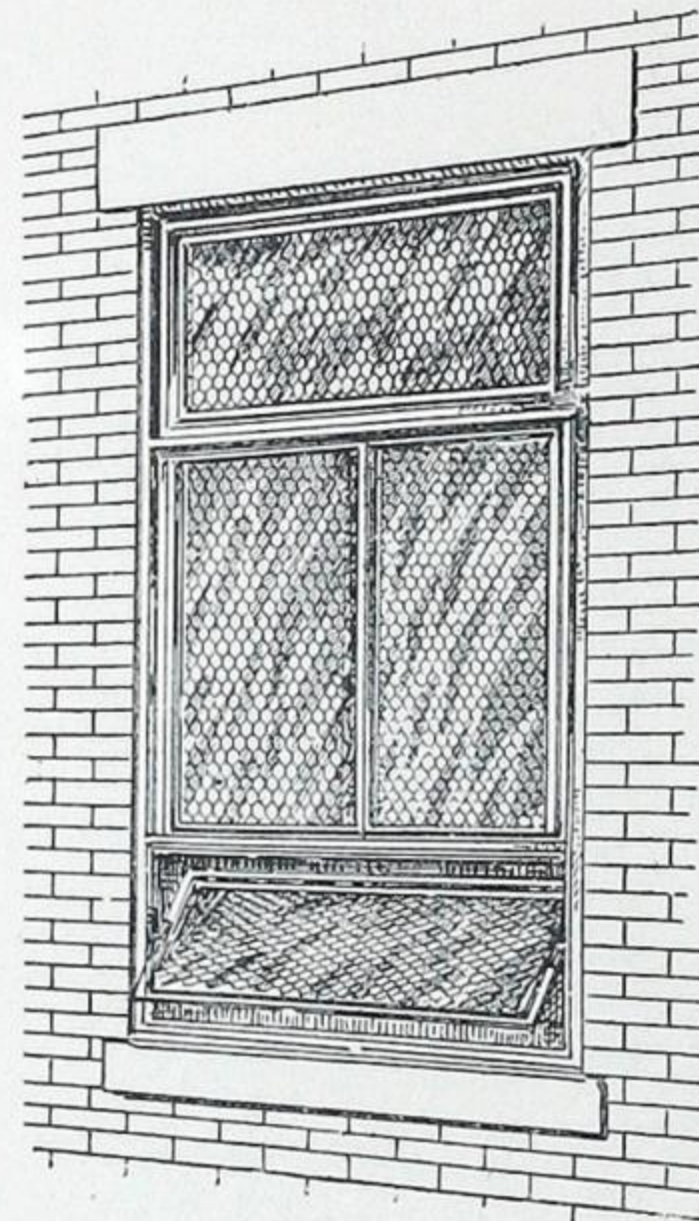

Fig. 159.

of Fire Underwriters, who give reduced insurance rates where they are used.

These windows obviate the use of iron shutters, which often overcomes the necessity of striking matches or of carrying artificial light in a darkened room during daylight, and they also overcome the objection of firemen against shutters when fighting fire, of offering obstruction, as if necessary they may be chopped away, and an opening effected.

The sheet metal frame, when properly constructed and cared for, when made of galvanized or tinned iron, will last as long as any other part of the building, and when cold rolled copper is used, its duration is without limit.

Price on receipt of specification giving number of windows, description of the kind of sashes required, and size of opening.

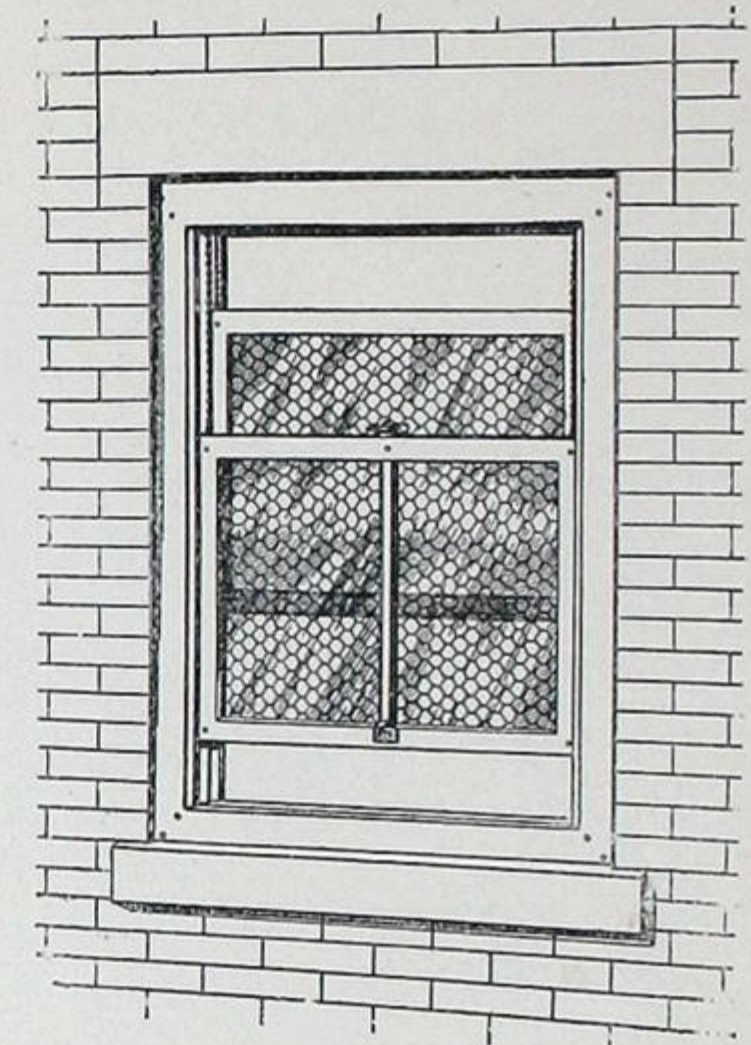

Fig. 160.

The original and genuine fire-proof windows all have our name-plate securely attached to them.

THE "HAYES" PATENT METALLIC LATHING.

AND SYSTEM OF FIRE-PROOF CONSTRUCTION.

Patented—January, 1889; October, 1891; October, 1891; December, 1891.

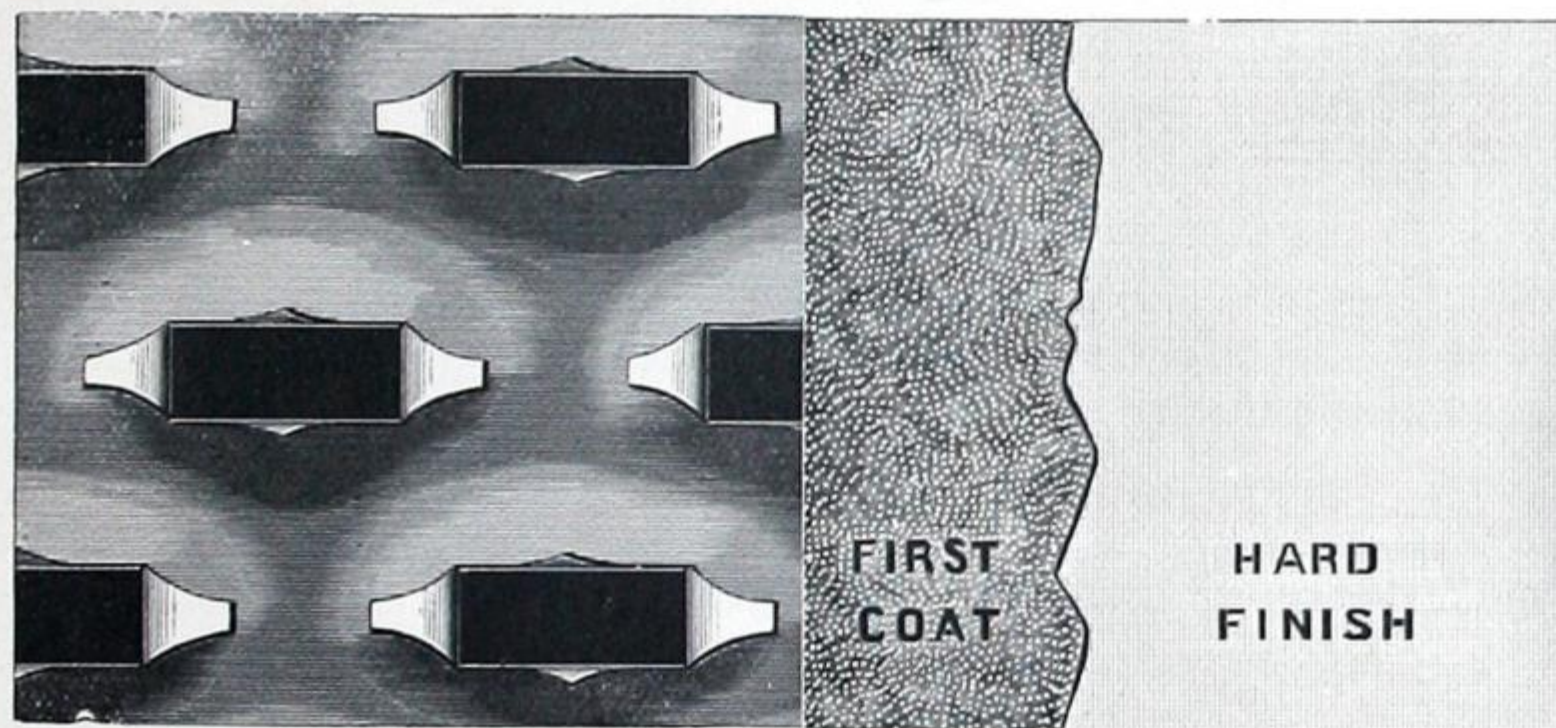

Fig. 161.

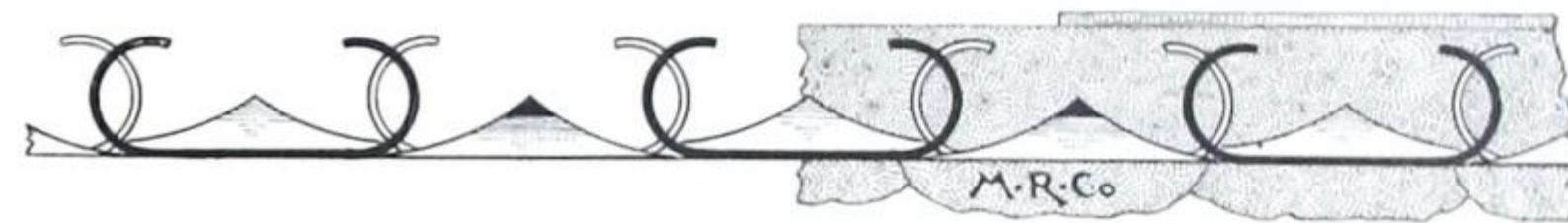

Fig. 162.

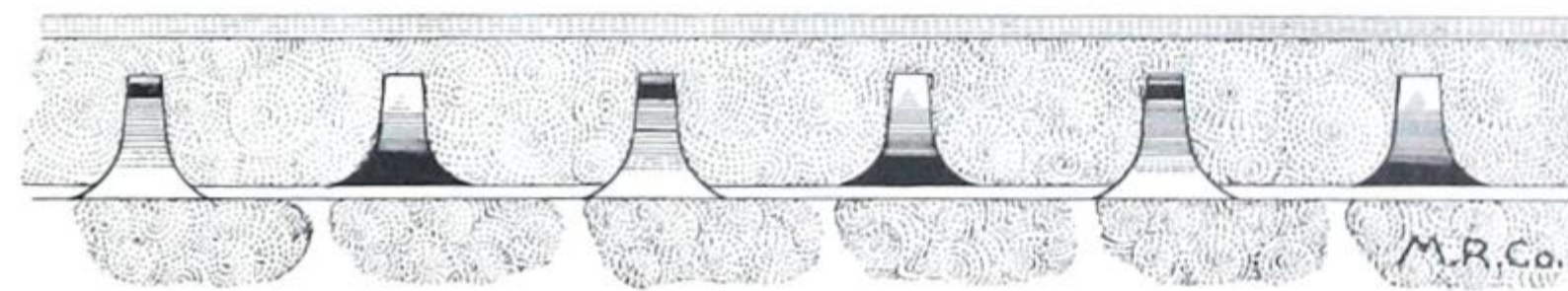

Fig. 163.

Fig. 161, elevation of lathing having a portion of its face covered with "one coat," and a portion with "hard finish" as second coat, with Figs. 162 and 163 sections of same.

Standard sizes of sheets are 15 x 72 inches and 15 x 48 inches.

Special sizes, 30 x 48 inches, 30 x 72 inches, 30 x 96 inches, and 15½ x 96 inches.

Standard weight of lathing is about 5½ lbs. per square yard. Packed in bundles containing ten square yards each.

Amount of Lathing we give for ten square yards: 18 sheets, 15 x 48 inches; 12 sheets, 15 x 72 inches; 9 sheets, 30 x 48 inches; 9 sheets, 15 x 96 inches; 6 sheets, 30 x 72 inches; 4½ sheets, 30 x 96 inches.

Description.

THE "Hayes" System of Lathing, for which we own all Canadian patents, is composed of sheets of iron or steel, over the surface of which at near intervals are openings $\frac{5}{16} \times \frac{3}{4}$ of an inch, produced by a process of puncturing. The flanges around the openings are pressed forward and curled backward, forming lips and hooks which clinch or hold the mortar to the surface of the sheets, while at the base of each opening is formed a matrix into which the mortar is pressed, and by which perfect dovetailed clinches or bonds are obtained. The process imparts to the sheets an undulated surface, giving additional strength thereto. The mortar or plastering material is spread over the surface of the sheets, embedding the lips and hooks and filling the matrix, thereby permitting a degree of coalescence which insures most perfect and substantial work, without sagging or deflection, and imparting a most surprising solidity and firmness, that of a stone-like character. Ribs are also introduced at intervals over the surface of the sheets. The rigidity is not equalled in any other known method of hollow wall or ceiling construction.

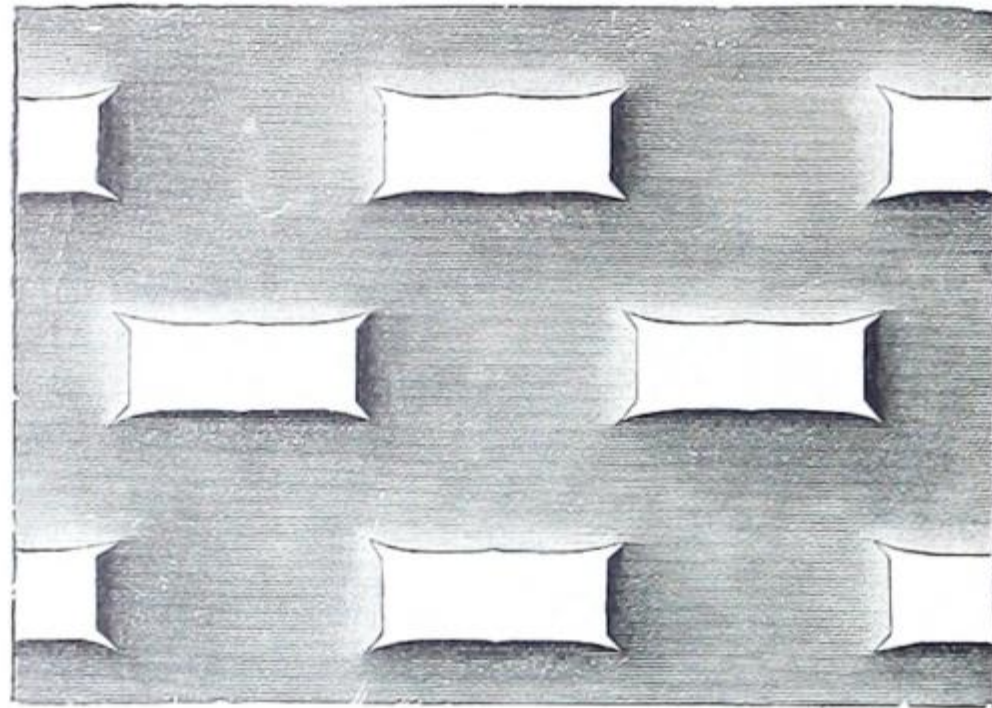

Fig. 164.

The above illustrates the back of the apertures (full size) of our lathing, showing that no sharp edges occur, but that the tongues or clinches of mortar rest upon an easy bearing.

No cracking or falling away of the surface of wall or ceiling can occur, neither can it be removed in any other manner than by the mechanical operation of picking it off by particles.

How Supplied.

THE lathing is supplied either in plain black iron or painted on both sides. Where lime mortar is used it is not necessary to use the painted lathing, as the alkali in lime completely neutralizes corrosion, but where plasters are used in which alum, muriatic or other acids are substituted for lime, then the painted sheets should be used.

Expansion and Contraction.

THERE is an entire freedom from expansion or contraction or any organic action which will disrupt, strain or in any manner injure the bond. A plain plate of iron when subjected to great heat will become distorted; but a perforated or punctured plate is that assumption of form which cannot in itself be destroyed or affected by fire or water, separately or combined, no matter how fierce the action may be.

Fire, Water and Vermin-Proof.

IT is borne out by practical experience that timber, when encased with this lathing and covered with good mortar, is perfectly safe in fire-proof construction, and it is utterly impossible for fire to reach the timber so long as the mortar is held to its surface, and when the apertures are provided with the projecting features which characterize this lathing, and become embedded with plastering material, the most obdurate attacks are effectually

THE METALLIC ROOFING COMPANY OF CANADA, LIMITED, TORONTO, CANADA.

resisted. It also equally resists the combined and antagonizing elements, fire and water, and further demonstrates that no matter how a ceiling or wall may be deluged by water, whether from a leaky roof, bursting of pipes, or in the extinguishing of fire, the coating of plastering material can only be removed mechanically, and will hold firmly to the lathing so tenaciously that little damage can arise under any circumstances, and a saving in the cost of fire insurance is effected.

It is manifest that rats, mice and other vermin cannot gnaw their way through a partition or ceiling, neither can they be harbored therein.

Covering Pipe Chases.

THIS lathing is extensively used in the heating trade for covering pipe chases, hot-air flues, and for purposes where great variation of temperature exists. Steam boilers and steam pipes have been most successfully jacketed, and, when subjected to critical examination, both in a cold and heated condition, have proven under every circumstance to be very satisfactory, thus setting at rest any question as to the organic action of expansion or contraction.

Supports Required.

FEWER supports are necessary than for any other mortar-holding device. This lathing makes rigid and substantial work when applied to supports up to sixteen-inch centres.

The plastic nature of these lathing sheets is such that any form is readily made (upon which to make a plastered face) from a simple internal or external angle to the most complex shapes, including those required in the formation of pilasters, columns, capitals, bases, girders, niches, groins, cornices, wainscotings, casings, trimmings, etc. Large, heavy and bold mouldings, coves, etc., may be formed without the usual bracketing or support, and oftentimes by merely bending by hand when in the act of securing it in its place, and at no expense other than its plain surface measurement. Where extraordinary large coves are required, a most simple support at their back can be provided by intercepting the cove at the centre of its periphery with a lateral bar secured to an iron support at right angles thereto, attached to the wall and ceiling diagonally and placed at certain intervals, thus avoiding the usual wooden supports, which render a building liable to fire by having so much open and unprotected woodwork arranged in a most effective manner for igniting and communicating fire.

Another method which is adopted is to reinforce the back of the moulded lathing with bar iron bent to conform to the general outline in the same manner as exterior metal cornices are held to their shape, and another by forming a skeleton framework of bar iron, to which the lathing sheets are wired.

Lathing Readily Applied.

A workman can, in the same space of time, apply a great deal more of this than he can of wood lathing. The single sheets contain from one-half to over two yards each, and ordinary skill only is necessary in applying it.

Portable Forms in Lathing.

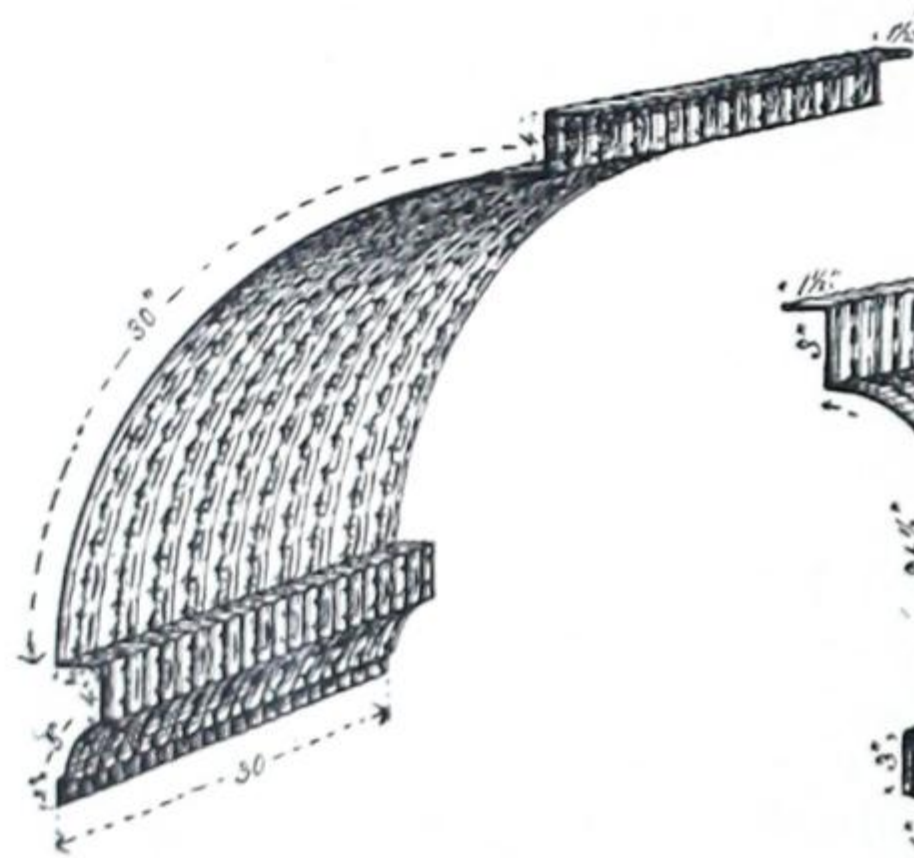

Fig. 165.

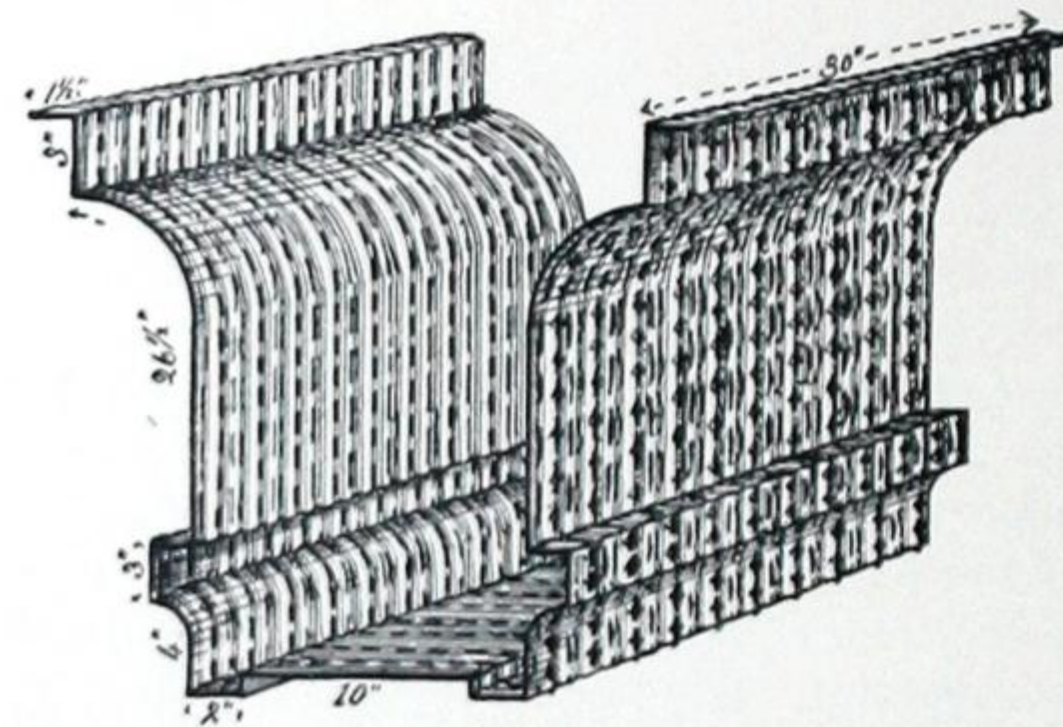

Fig. 166.

Fig. 165 shows a form into which our lathing may be bent in thirty-inch lengths, by a girth of forty-nine inches.
Fig. 166 shows a form thirty inches long by a girth of ninety-six inches, or the whole length of the sheet being bent crosswise.
It is obvious that light, yet strong and reliable work is accomplished by this method, with no unnecessary waste of plaster.
These examples are given simply to show how indefinitely this system may be carried out, and to what advantage.

Brick Walls.

When the lathing is applied to the interior of exterior walls the ordinary furring strip may be used; the fire-proof qualities of the lathing will protect them in the same manner as it does the wood studs, or metal furring strips may be used if preferred.

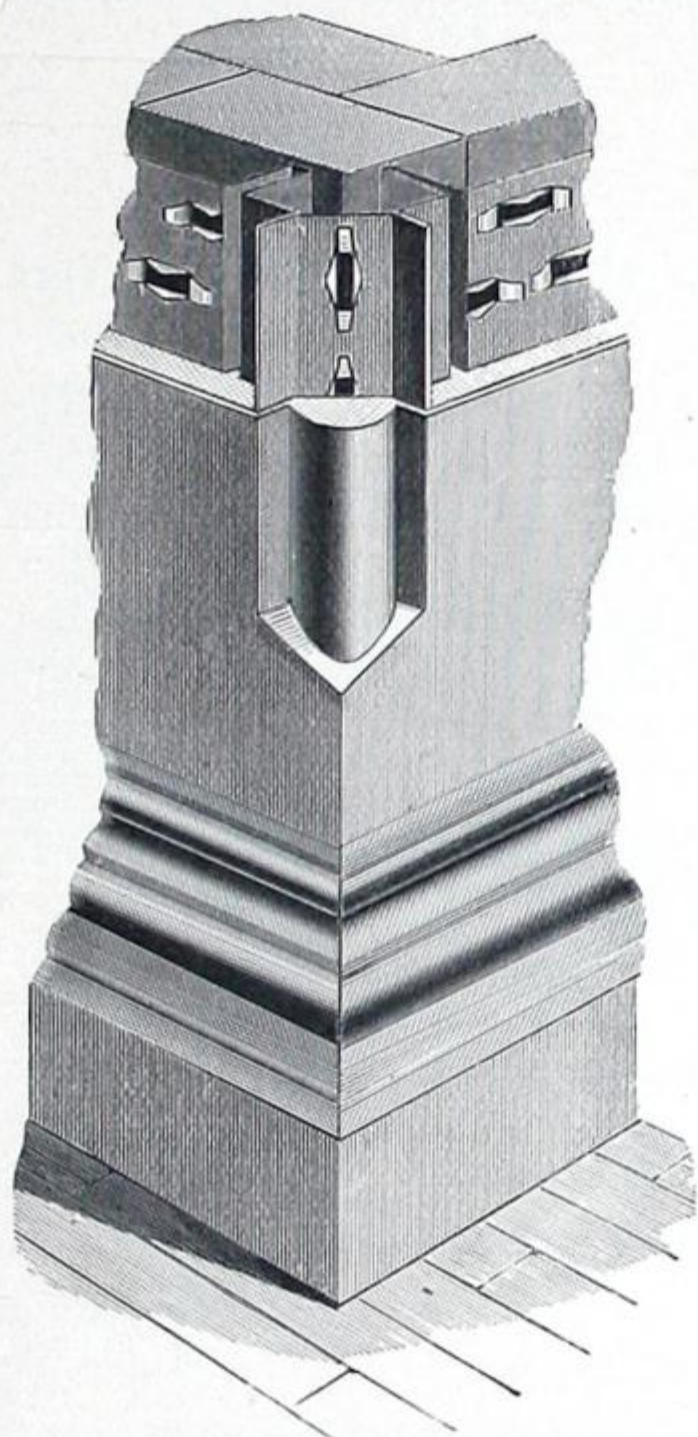

Fig. 167.

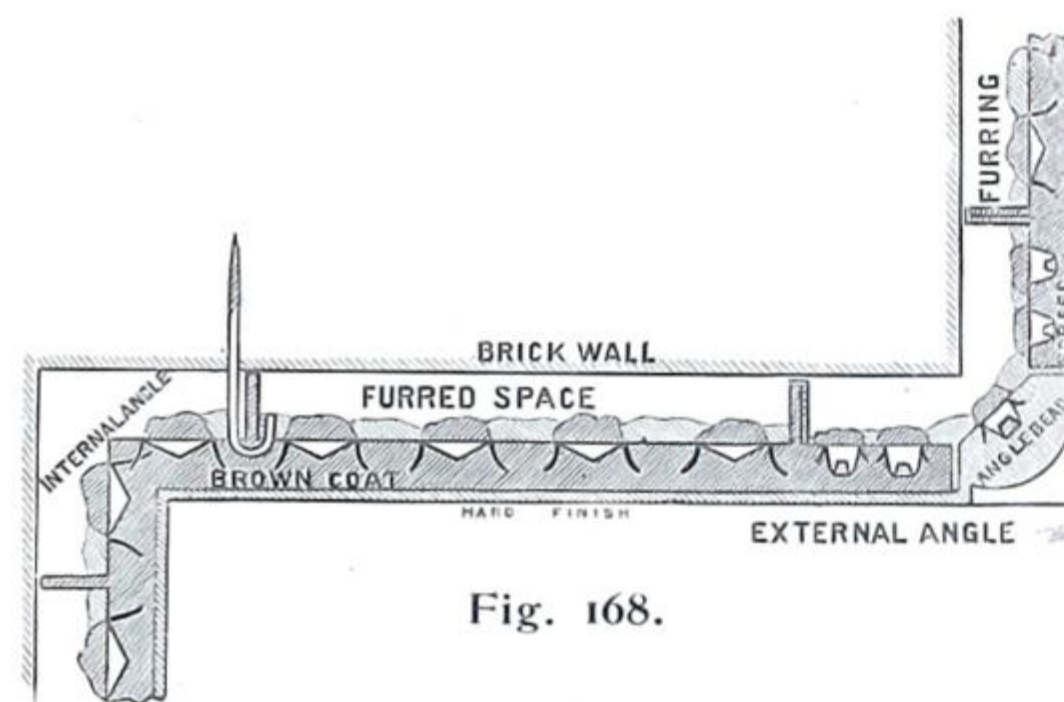

Fig. 168.

Fig. 167—Perspective, showing external angle of brick wall with lathing, furring, screeding, stopped-off angle bead, and cement base.

Fig. 168—Section of lathing applied to brick wall, showing the combination of lathing, furring and screeding, also an internal and external angle, with stopped-off angle bead, and two coats of plaster.

Cutting New Doorways.

In the event of a doorway or other opening being required to be made in a finished wall where this lathing has been used, no difficulty will be encountered. The mortar or face can be cut to the line with a sharp tool, the lathing can then be cut down with a sharp chisel or hacking knife and the whole piece taken out at once, thus avoiding the floating dust usual in such an operation.

Hanging Pictures to the Walls.

NAILED may be driven indiscriminately into the surface of the wall without regard to the studs. Screws or screw hooks, or other devices, with either nail or screw shanks, can be effectually applied without injury to the wall or bond. No attachment to a wall is more secure than a screw properly applied where this lathing forms part; the tenacity with which the mortar is grasped and held by the lathing effects such a degree of coalescence that this important requirement is effectually accomplished.

Ventilating Cornice.

THE ventilating cornice in the banqueting room of the Scottish Rite Hall, corner of 29th Street and Madison Avenue, New York City (the room is forty feet by seventy feet), is formed as follows: The side walls are composed of a series of piers about four feet wide. Between each pier a chamber is formed by a skeleton frame, the vertical face of which receives the cornice. This cornice is run all around the room and between the pier and at other points where a soffit is presented, instead of being plastered it is left open, forming a grating through which the heated air and tobacco smoke pass up into the back of the cove of the cornice, which forms a duct, conveying it to two large tubes connected with heated flues, affording an escape.

Ventilating Flues.

AT the Young Women's Lodging House (Y.W.C.A.), in 16th Street, New York (R. H. Robertson, architect), sets of ventilating flues were most successfully formed as follows: Commencing each set at the first floor with two flues, and increasing one flue to each room (provided with a register), to the fifth floor, opening into the space between the ceiling and the roof, where sufficient provisions were made for carrying off the vitiated air. The flues formed the partition walls and were in section, thus:

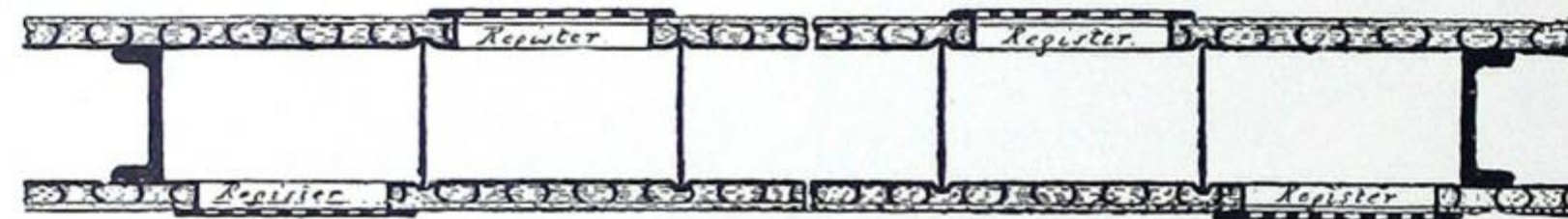

Fig. 169.

Fire-Proof Ceilings where "I" Beams are Employed.

IT is of course desirable that every portion of a building when attacked shall not only resist fire, but shall be equally invulnerable against water, and also the combined effect of both, when one element is used to combat the other. It is also essential to so arrange the structural parts that they will not contribute to the demolition of the building—as, for instance, unprotected iron columns or the iron beams of a floor filled in between them with arches of brick or tile or other material that will, under the action of the iron when influenced by fire and water, thrust out horizontally, and otherwise cause the whole structure to collapse, and which will also, when charged with excessive weight and thrusting power, settle and cause the beams to deflect, binding and holding them fast in that condition.

THE METALLIC ROOFING COMPANY OF CANADA, LIMITED, TORONTO, CANADA.

Brick Arches and Corrugated Iron Arches filled in with concrete weigh about seventy-five pounds to the square foot; the Flat, Hollow Tile Arches from thirty to sixty pounds to the square foot. In order to dispense with these excessive weights, we furnish a substitute that will weigh but fourteen pounds to the square foot, including Metallic Lathing Blocks, Plastering and Concrete, and which will not contribute in the least degree to the derangement of a building by thrusting in any direction, and which will also resist the attacks of both fire and water, protecting the beams therefrom.

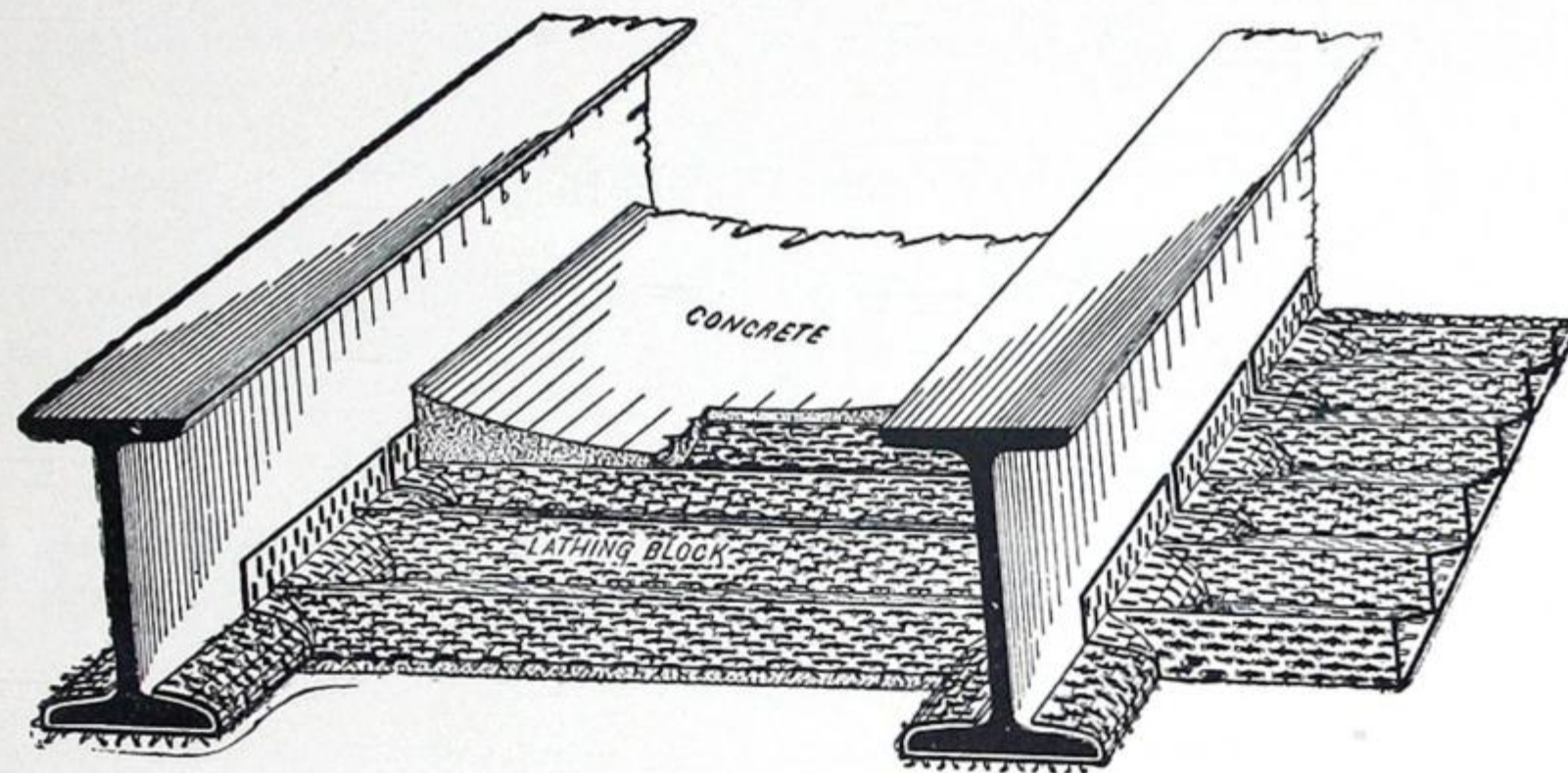

Fig. 170.

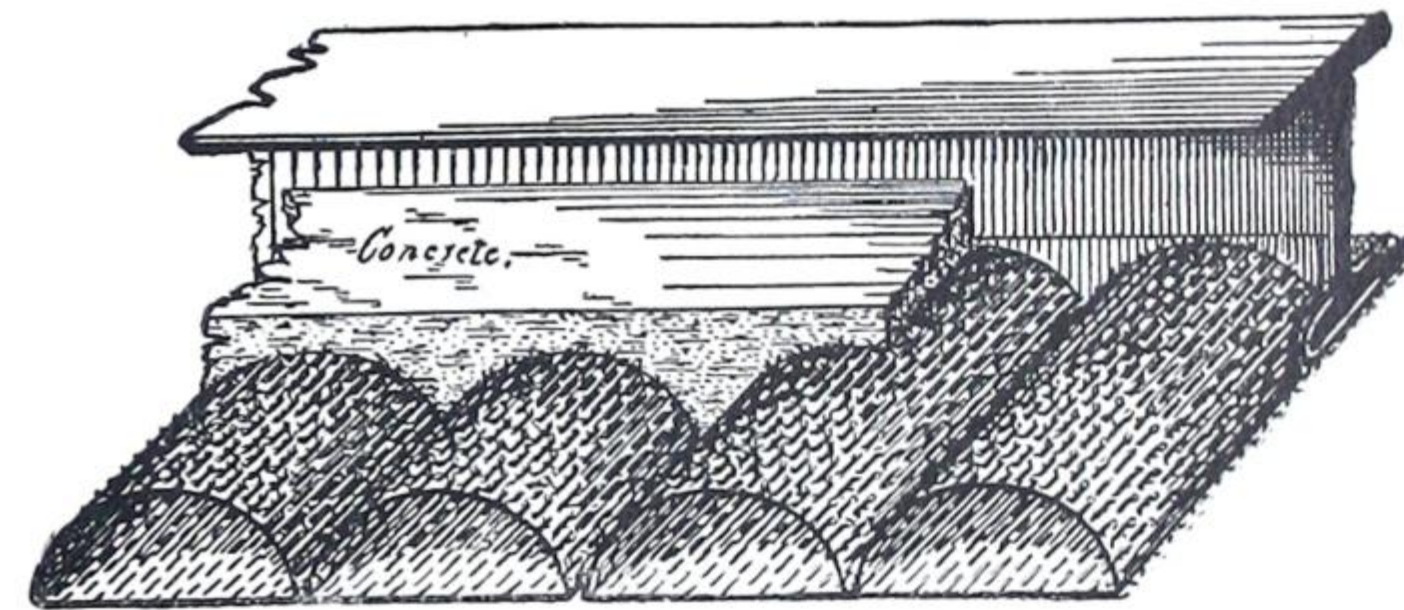

Fig. 171.

Figs. 170 and 171 illustrate portions of ceiling in which the lower flanges of the beams are clothed with lathing, and resting upon the flanges are a series of hollow blocks formed up out of the sheets of lathing of the desired depth, laying side by side and across the opening. Over these is spread a layer of concrete, which is received into the punctures and held by the hooks or clinches in such a manner that, when the concrete is set, a substantial lintel is acquired, which is even with the bottom of the clothed flanges of the beam, presenting an even surface to receive the plastering coat constituting the ceiling, and deafening with the essential dead-air chambers, which may be made to occupy almost all of the centre space between the flanges of the beams. The union of the parts is complete, firm and thoroughly fire-proof.

No fastenings or other means are necessary to attach or secure the blocking to the beams, the concrete and plastering material performing that office thoroughly.

These blockings are made of various depths so as to accommodate the various spaces between the beams, or to receive an intermediate bearing for the floor or floor supports. Where deep blockings are arranged a large amount of dead-air space and at the same time a very rigid lintel block is acquired.

THE METALLIC ROOFING COMPANY OF CANADA, LIMITED, TORONTO, CANADA.

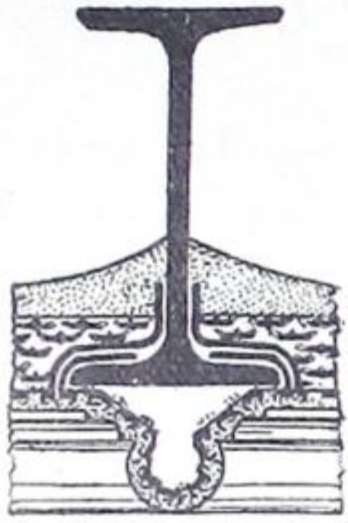

Fig. 172.

For level ceilings (composed of iron or steel beams, and where the blockings or lintels before described are not used), we adopt a malleable iron carrier which supports an angle, **T** or bar iron bearing, and which is secured to the flanges of the beam running transversely, and to which the lathing sheets are securely wired.

A very beautiful effect may be produced by forming a series of groined arches instead of a level ceiling, by bending the lathing sheets into the desired form, over the upper side of which the concrete is spread, while the under side receives the plastering coat. The flanges of the beams may be encased with the lathing, moulded, and forming the abutment of the arches, as shown in Fig. 172.

Lathing Readily Plastered.

A WORKMAN will, in the same space of time and with greater ease, plaster a considerably greater area on this lathing than he can upon any other. It is obvious that the moment the mortar comes in contact with the surface it is grasped by the tongues and held in the apertures, causing instantaneous adhesion, and no dropping or falling off occurs, consequently there is no waste and no undue thickness of coat on either the face or back of the lathing.

Saving of Mortar Effected.

A given amount of mortar will cover a much larger surface on this lathing than on any other, excepting those which afford a very indifferent or inadequate key, and which in consequence, saves mortar at the expense of the key or bond.

Saving of Floor Space.

Partitions, as elsewhere described, occupy from one to two and one-half inches, while possessing the strength of brick walls.

Economy by the Use of this Lathing.

THE many advantages this lathing possesses over wood or other lathings, combined with its fire-resisting qualities and consequent saving in insurance and also saving in quantity of mortar used, should recommend its use in buildings of the most ordinary character, and it will be found that, all things considered, our lathing is the cheapest in the end to use. As compared with other metallic lathings it is a conclusion freely expressed by the trade that "it is the best lathing on the market."

Wood Construction Rendered Fire-Proof.

WOOD as a building material is undoubtedly the most useful of all structural agencies, being easily shaped and readily applied, and but for the lack of its fire-resisting qualities would be perfect. This deficiency, however, has been overcome, and buildings may be rendered fire-proof even when timber-framed.

This lathing is exceedingly well adapted to the protection of wood **columns, girders, beams, studded partitions**, etc., or when the entire construction is of timber, and which may be made substantially **fire-proof** without materially (if at all) increasing the cost of the most ordinary

THE METALLIC ROOFING COMPANY OF CANADA, LIMITED, TORONTO, CANADA.

construction. This applies to the exterior as well as the interior of buildings, and obviates the necessity of resorting to the expensive and manifestly inadequate so-called fire-proof construction, where unprotected iron forms so conspicuous a part. Better results are attained without the incidental and costly outlay of such.

Buildings constructed of brick and timber, properly protected, are much less liable to destruction.

The heads of the various fire departments, both in this country and in Europe, have often referred to this fact and always exercise great caution in entering or approaching so-called fire-proof buildings during a conflagration for fear of falling walls.

A good brick and timber-constructed building, lathed with Hayes' Metallic Lathing, will be found to be more thoroughly fire-proof and less expensive than any other known method. In every case it is of the utmost importance that the lathing and plastering should extend to the floor line, and that all wainscoting, base, etc., should be placed against a plastered ground.

Angle Beads.

Where wood lathing is used, our "Hayes" Steel Lathing may be used to great advantage at the corners of rooms to prevent the mortar cracking or dropping off, as our lathing makes the very best angle beads.

Wood Studded Partitions.

WHEN the lathing is nailed upon wood studding, ceiling beams or wood furring it is secured with steel wire nails one or one and one-quarter inches long—or the ordinary slating nail will do—taking care to nail in a vertical (straight) line down the centre of stud, beam or furring strip in such a manner as will allow them to shrink without conflict; where the sheets overlap each other the same rule should apply. For interior and exterior angles the sheets are bent to conform, and thus prevent any cracking of the plaster at these points. Sheets should always be applied horizontally.

Ceilings (Wood Beams).

IN applying this lathing to wooden beams the same rule should be observed as in nailing to wooden studs. It is advisable to begin at the floor line, working up the walls to a point where the cornice commences, bending the sheets to the approximate form of the moulding, continuing along the beams to the completion of the ceiling. The spaces between the studs, as also between furring strips, where such are used, should be filled in with plain sheet iron, or bricked up two or three courses, so as to cut off all draughts. Flues are inadvertently formed of this and many other points in the structural parts of a building, but should be zealously guarded against, as there lies the cause, in very many instances, of the rapid communication of fire. This precaution will also bar the accessibility of rats, mice, and other vermin.

The weight of this lathing, when plastered, is from four and one-half to five pounds per square foot.

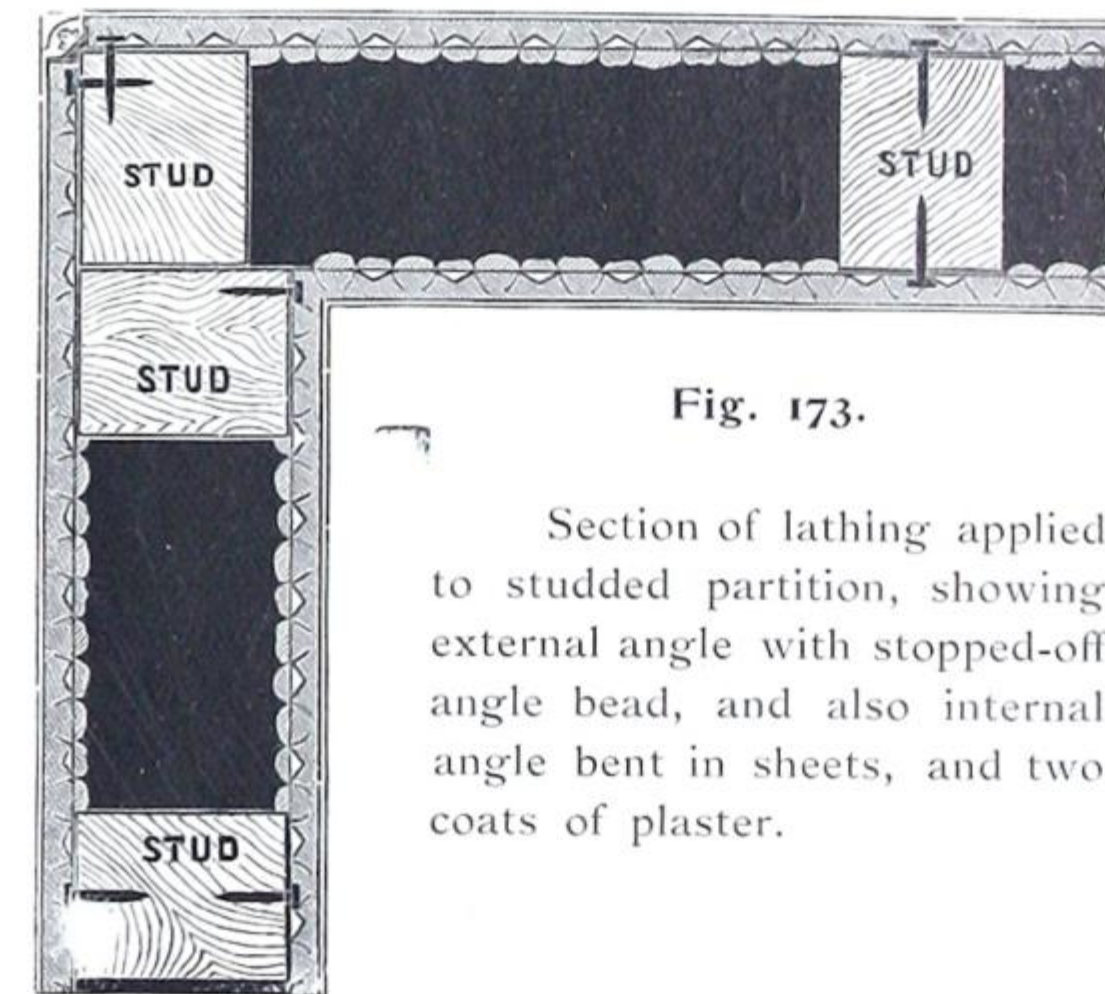

Fig. 173.

Section of lathing applied to studded partition, showing external angle with stopped-off angle bead, and also internal angle bent in sheets, and two coats of plaster.

Iron Girders, Columns, Etc.

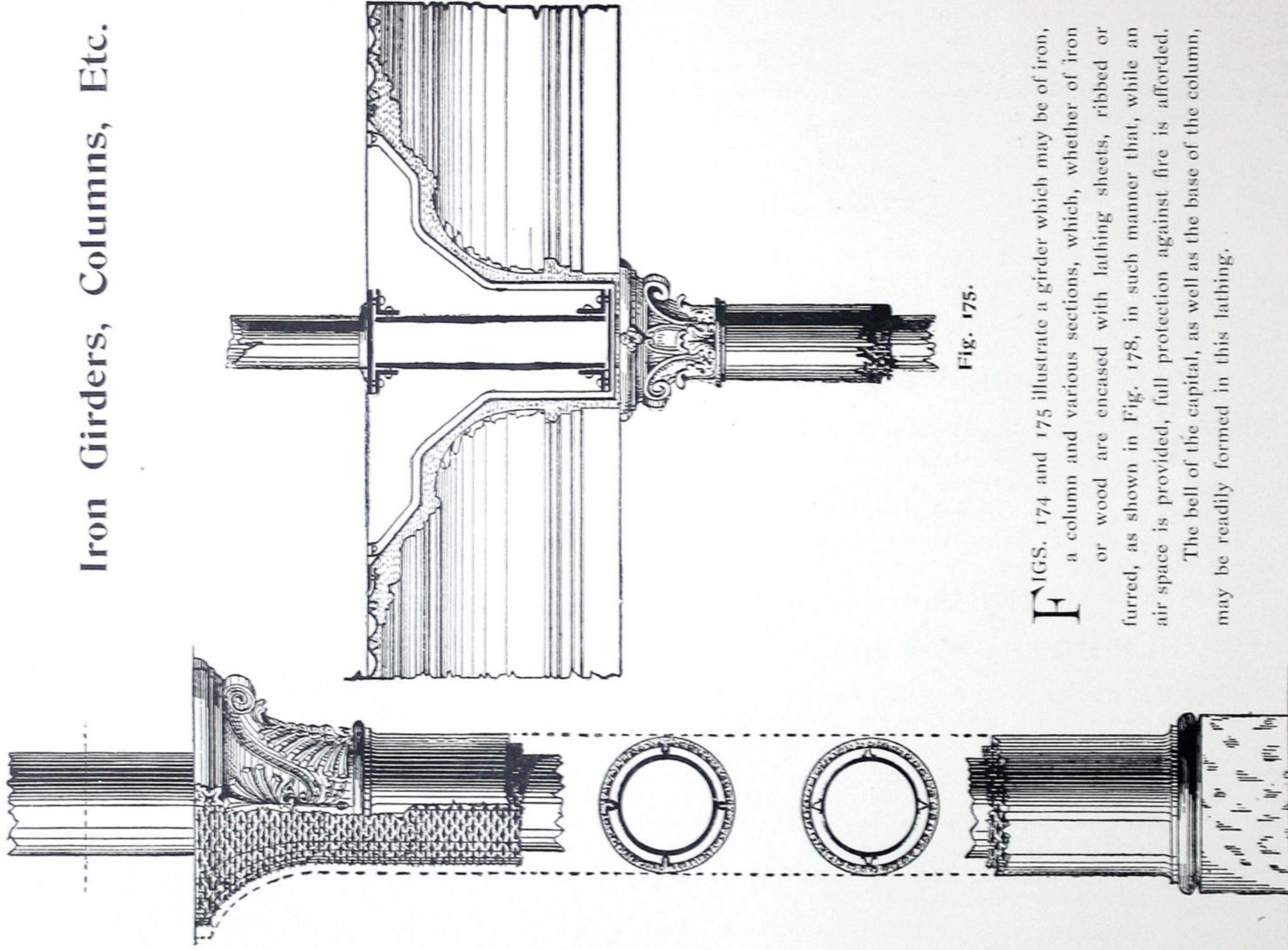

Fig. 174.

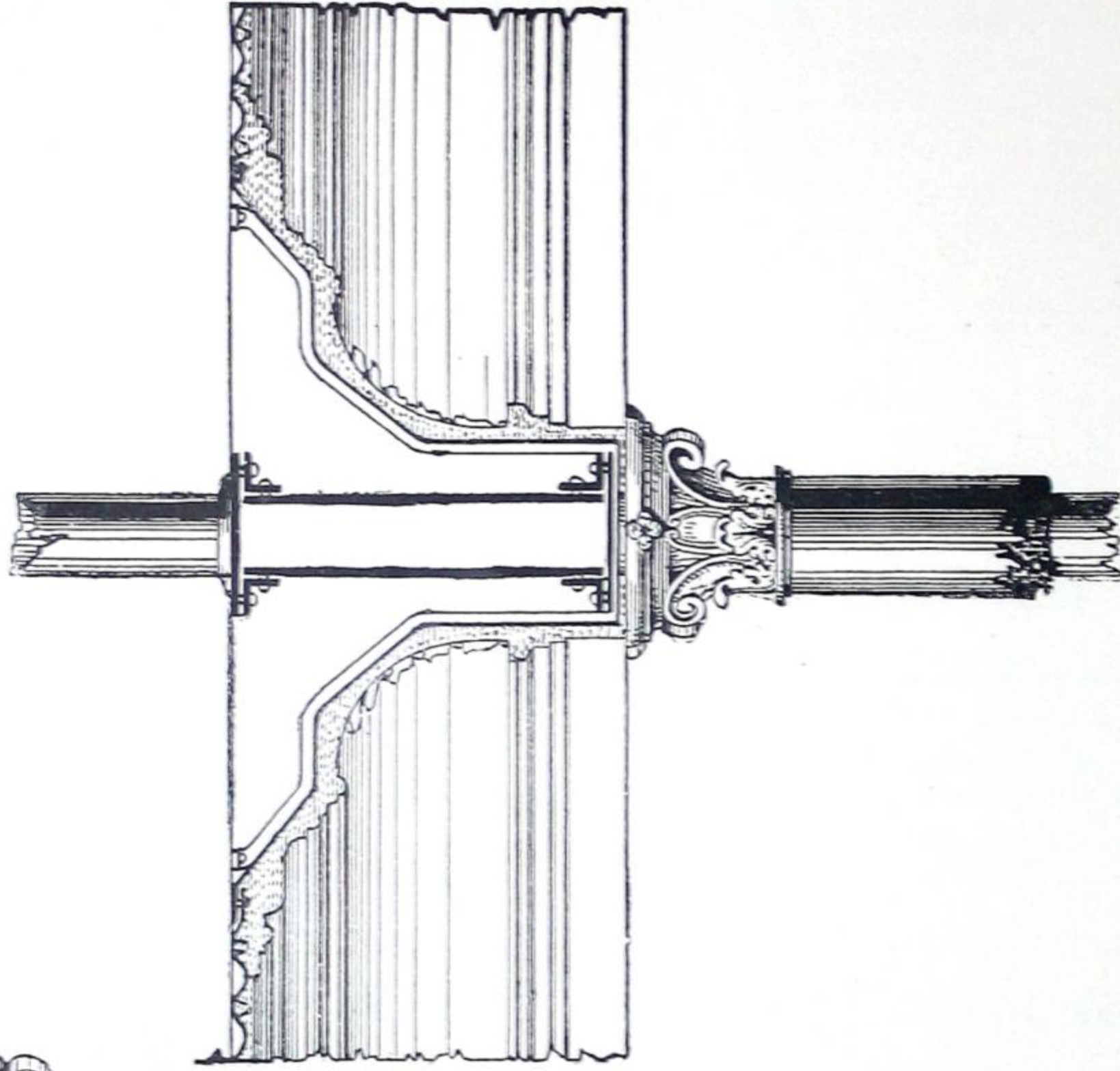

Fig. 175.

FIGS. 174 and 175 illustrate a girder which may be of iron, a column and various sections, which, whether of iron or wood are encased with lathing sheets, ribbed or furred, as shown in Fig. 178, in such manner that, while an air space is provided, full protection against fire is afforded.

The bell of the capital, as well as the base of the column, may be readily formed in this lathing.

Fire-Proof Floors on Wood Beams and Flooring.

A FIRE-PROOF floor may be made by nailing the lathing sheets over the boarded surface, and then with a proper mixture of gravel, sand and cement, or other suitable concrete, a permanent and effective fire-proof floor will be produced, which may be arranged in variegated colors or ornamental design, or may be laid in tiles of tessellated pavements.

This, in conjunction with a furred and cemented base, most effectually cuts off fire and prevents its spreading. By making halls and stairways fire-proof in this manner the natural and most accessible escape in case of fire is preserved. This may be accomplished in old buildings by covering the walls, floors and ceilings as they are with this lathing and then apply a second plaster coat.

Troughed or Water-Proof Floors.

FOR bath-rooms, wash-rooms, laundries, etc., by covering the floors as before described, and by turning up the lathing on the walls, a perfect cemented troughed floor may be made. A good result is obtained in kitchens, hall-ways, closets, etc., where the walls up to the surbase are subject to much wear or dampness, by covering this lathing with Portland cement, which may be painted and can be easily kept clean.

Partitions Composed of Angle Iron, Metallic Lathing and Mortar.

WHERE economy of space in the construction of buildings is now such an important factor, partitions as hereafter shown and described should prove worthy of the earnest consideration of architects and builders.

Partitions constructed in accordance with the method here presented, though but $1\frac{1}{2}$ to $2\frac{1}{2}$ inches in thickness, and very light in weight, are thoroughly fire-proof, and can be used to great advantage in many ways. Dead-air chambers, non-conductors of sound, heat and moisture, are acquired throughout, also convenient means for communicating gas and water pipes and electric wires, or when required the dead-air chambers may be converted into live-air chambers. If desired the chambers may be filled in with concrete, mineral wool, asbestos or other filling.

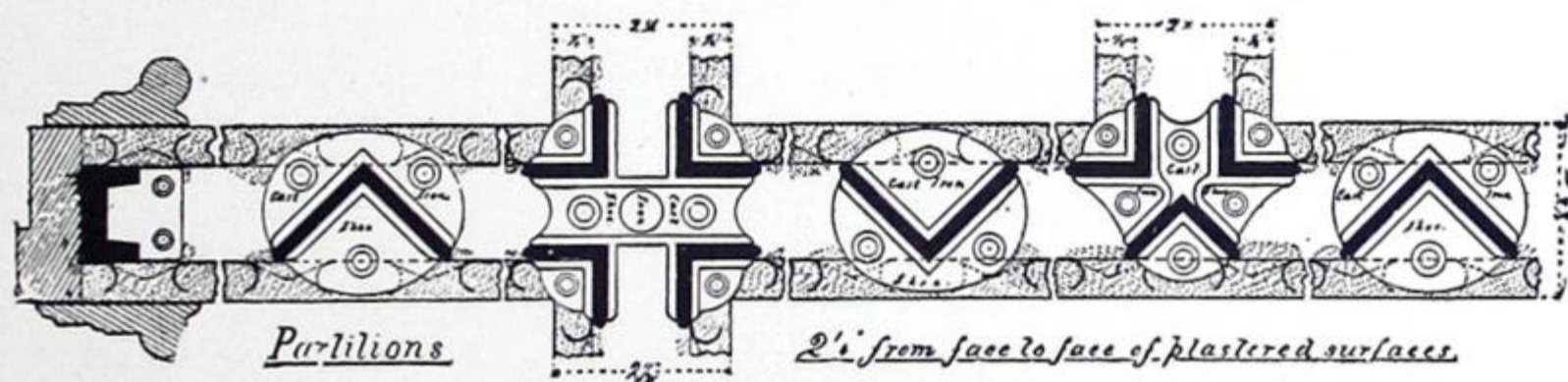

Fig. 176.

Shows a horizontal section of a partition constructed at the Harlem Opera House, New York, which formed the walls of the private boxes. It consisted of cast-iron shoes, which were secured to the floor and the ceiling, into which one-inch angle iron studs were placed alternately, thus— $V \wedge V$, so as to give a good bearing to the metallic lathing, which was securely wired to these studs on both sides, and where cross-partitions intersected, shoes shaped to the requirement, as shown, were applied conforming to the line and angle of the main partition. This partition, when plastered on both sides, was $2\frac{1}{2}$ inches in thickness, and was very substantial and thoroughly fire-proof.

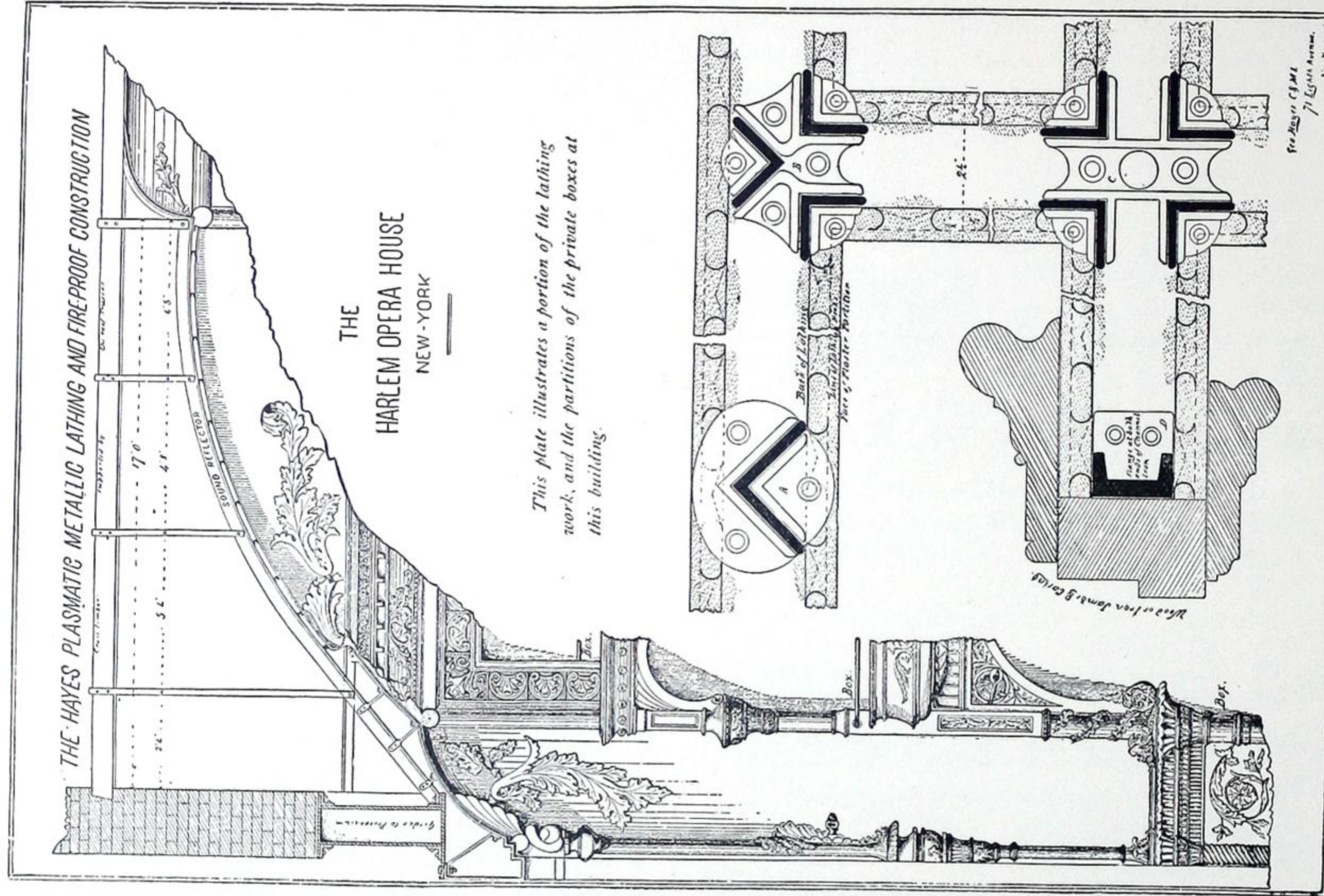

Fig. 177.

Iron Furring Strips.



Fig. 178.

Illustrates in cross section furring strip $2\frac{1}{2}$ or 3 inches wide, formed out of sheet iron in any length required. It is used on all places where a dead-air space is wanted, and can be furnished with crimps in sheet any distance apart.

Non-Radiating Jackets.

For Retaining Heat in Steam Boilers, Hot Air and Water Heaters, Flues, Pipes, Sugar Dryers, Kilns, Drying Rooms, or any other Heat-Retaining Devices affording Dead-Air Chambers.

THE "Hayes" Patent Lathing can be used to great advantage for the above work.

The furring strip, as illustrated in figure 178, is used to keep the lathing away from the boiler, thus providing dead-air chambers, the best means of non-radiating heat therefrom, as well as keeping the cooling atmosphere outside, and the lathing is then plastered.

When desired, the jackets may be made portable by bending flanges in the lathing upward above the surface, where the two sections join, which enables the sections to be bolted together through the flanges thus formed, making a ready means for removing or uncovering the boiler for any purpose that may be necessary.

The plastering material may be of the most ordinary kind, mixed rather stiff, as the hooks or apertures in the lathing will grasp and retain it to the surface most effectually.

This application takes up very much less room than brick work and costs considerably less, producing a most perfect result.

Walls and Ceilings Sheeted with Wood.

IT is almost **criminal** to sheet either walls or ceilings with wood, unless upon a **lath and plaster** ground, as it may, through the non-fire-resisting qualifications, be the means of causing **loss of life**. Besides, it often happens that fire is communicated by immediate contact with electric wires, where they are not intercepted by plaster. Mr. F. C. Moore, president of the Continental Fire Insurance Company of New York, and a member of the Board of Underwriters, in his Treatise on Buildings, says:—

"Hard Wood Finish, Wooden Ceilings, etc.—Probably few persons are aware of the increase in the number of fires resulting from the modern practice of constructing buildings, especially offices and dwelling houses, by substituting ornamental woods, often yellow pine, with varnished surfaces, for ordinary lath and plaster. The latter is a resistant of fire; the woodwork, as may be well understood, contributes to its ignition and to its spread. Moreover the necessity of oiling the woodwork from time to time, by

THE METALLIC ROOFING COMPANY OF CANADA, LIMITED, TORONTO, CANADA.

servants ignorant of the dangers of spontaneous combustion, leads to many fires whose cause is never known or even suspected. It is natural for a servant to cast an oily rag, after using it, into some out-of-the-way place or rubbish barrel, where the conditions of confined air ensure a sufficient rise in temperature to cause spontaneous ignition. This is exceedingly liable in the case of linseed oil, or any of the vegetable oils, kerosene oil alone being free from the danger of spontaneous ignition.

"It is bad enough where wooden ceilings are thoroughly backed up by lime mortar, so as to prevent the draft incident to hollow spaces, but where, as is generally the case, the wooden ceiling is simply fastened to the wooden floor beams, the construction is most dangerous and the progress of a fire exceedingly rapid, as in the case of the burning of the dwelling house of Hon. Benj. F. Tracey, Secretary of the Navy, in Washington, in 1890, in consequence of which Mrs. Tracey lost her life. In this instance not only were the dados and ceilings of ornamental woods, but the parlor walls themselves were finished in hardwood from floor to ceiling, with air spaces behind the panels. Notwithstanding that the fire caught a few minutes before the breakfast hour in the morning, while men servants were actually at work in the adjoining dining-room, the spread of the flames was so rapid as to defy the efforts of the fire department to save life and property.

"Wherever wooden ceilings are employed, a ceiling of plaster and metallic lath should be first fastened to the beams. To this plastering the wooden ceiling may be attached. In this case the wooden ceiling itself might be burned, with large chances in favor of saving the building itself."

Metal Lathing.

The Chicago Post Office.

"The Chicago post office building has for the past few months been in process of demolition, to be succeeded by a larger and finer structure on the same site. It was erected in the years 1872 to 1876, and was thoroughly fire-proof, having granite walls cast-iron columns, iron beams, **corrugated sheet iron floor arches with concrete top covered with tiles, metal lath** and iron roof frame work covered with slate. From the beginning of the work of demolition, frequent inspections of the metal parts have been made by engineers interested in noting what ravages had been made by rust. **A committee was appointed by the Western Society of Engineers to report upon the condition in which the iron was found.** This report has not yet been made, but much information has doubtless been secured which will be of great value. Other engineers have pursued independent investigations with results highly reassuring to those having faith in the permanence of iron and steel structures. **The metal lath taken from the partitions was found only slightly rusted from actual contact with the moisture of the mortar. It presented no evidence of progressive and continuing rust.** The side towards the partition was almost without deterioration. The **corrugated sheets** taken from the floors were of poor quality and exhibited numerous defects, clearly of mechanical origin, but **showed no damage from rust.** The upper side, on which concrete had been laid, showed bright metal when the adhering cement was scraped off. The under side, which had been painted, was well preserved. Pieces of the corrugated sheets taken from positions in which concrete had not been filled, leaving hollow spaces, had not sensibly rusted when exposed to such cavities. The beams and columns were all found in excellent condition, with even less indication of rust than would be shown if they had been lying for a short time in a builder's yard.

"A notable feature demonstrated was the fact that all iron work exposed to cement had been well preserved, indicating the indestructibility of metal foundations imbedded in cement. The metal lath on partitions covered with lime mortar had been slightly attacked by rust, as above mentioned, but the progress of oxidation had been temporary and not indefinitely continued as might have been presumed. The only places showing deep seated rust were a few locations in the roof, at which points there had evidently been leakages of long standing, but even in these instances the strength of the metal parts had not been materially affected. **The result of the inspection of the iron salvage from this building was particularly gratifying to those who use sheets in interior construction,** against which a prejudice has existed because of their presumed liability to rapid destruction by rust owing to their thin body. The makers of metal lath have also been benefited by the demonstration of the very slight ravages of rust. It seems reasonable to presume that, **if practically no damage was found after twenty years, the life of the metal parts of a building could be considered practically unlimited.** Importance is attached by the engineers from whom this information has been obtained to the fact that the iron used in this building had been well painted before it was covered."—*Metal Worker, New York, March, 1897.*

Metallic Lathing.

An Interesting Fact.

"Architects and plastering contractors will be interested in a test which was recently made by a plasterer in Toronto of the qualities of metal lath. The test was the outcome of the offer by a firm of manufacturers to supply metal lath at a considerably lower price than that of a competing firm. The plasterer, who is one of the most experienced men in his line in the city, undertook to decide for himself which material would in the end prove the cheapest and, all things considered, the best. In the presence of the agent of the company offering the cheapest lath material, he had two pails filled with plastering material made up in exactly the same manner, and with this he proceeded to plaster a piece of each kind of lath measuring forty-eight by fifteen inches. **The result showed that about sixty per cent. more plaster was required to cover the cheaper lath than was necessary to cover the more expensive kind**, and that by using the more expensive kind of material the contractor would effect a saving equal, if not greater than that which it was claimed the use of the cheaper lath would give him. There was an additional advantage due to the fact that it required much less labor to apply. **The actual amount of plaster used for the pieces, forty-eight by fifteen inches, was nineteen pounds as compared with thirty-one pounds.**"—*The Canadian Architect and Builder, March, 1899.*

The "Hayes" Patent Steel Lathing is one of the makes alluded to in the above test, and needless to remark is the one referred to as taking only nineteen pounds of plaster, as compared to thirty-one pounds of the opposing make.

We were not even cognizant of any test being made until after the contractor had satisfied himself and given us the order for the "Hayes" lathing.

Another point not brought out in the above paragraph, was that the sheet of "Hayes" lathing after plastering was a complete job, while the opposing lathing would have to be all levelled up over again to make a passable job, involving a considerable further outlay for time and material.

Not only this, but the opposing lath required a great many more supports, and cost considerably more to apply than the "Hayes" lathing, which can be applied up to sixteen-inch centres and is simply nailed to the joisting or studding with ordinary wire nails.

Mr. John M. Gander, contracting plasterer of Toronto, is the gentleman who made the test, and he estimates that outside altogether of the relative merits of the two lathings, that from his own standpoint, as a question of which would be the cheaper for him to use, there was a difference of at least eight cents a square yard in favor of the "Hayes" lathing.

Further comment is unnecessary.

"The above statements fairly represent the test as made by me."

TORONTO, April 20th, 1899.

[Signed],

J. M. GANDER.

To Prevent Death from Suffocation.

A PRACTICAL AND EFFICIENT FIRE ESCAPE.

By George Hayes, C. and M. E., New York.

"The following suggestions were published by me *pro bono publico* nearly twenty years ago, and as they have not been adopted or superseded and hundreds of lives have in the meanwhile been lost, which probably could have been saved, I now reiterate them for what they may be worth. The system of fire-proof construction herein set forth will very much facilitate the adoption of such an arrangement:—

"It is a fact that, in burning buildings, very few persons lose their lives by being burned; the immediate cause of death is due to suffocation by smoke, and their bodies are afterwards consumed by fire—the means of escape are often shut off by smoke, and not actually by fire. This was especially the case at the Newhall Hotel, Milwaukee, and the Brooklyn Theatre, the Hotel Royal, the Windsor Hotel, New York, and a long list of others. Experience should force upon us the necessity of providing easier and safer means of exit from burning buildings to the exclusion of the many unsightly and incompetent devices which disfigure the building, and too often lure the victim to a death more horrible than suffocation or burning, and which are applied only to fill the letter and not the spirit of the law.

"A fire escape should consist of a device that should not be a source of study to unravel its intricacies, or to the exercise of greater agility or courage than persons even under ordinary circumstances can command, and at a time, too, when persons are about to avail themselves of its use while under excitement, or indeed at any time.

"The arrangement I refer to consists of a communication from the street provided through the cellar or basement, separate and distinct from the other portions of a building, to the base of the stairway or elevator shafts, which should be used as a special ingress and egress in case of need, and all approaches to the stairways or elevator shafts should be guarded by Smoke Locks. This term I use in contradistinction from "Compressed Air Locks," as used in entering or leaving a submarine tunnel during its construction, being check valves. The smoke lock, as it would not have to contend against force, would simply be a smoke-tight vestibule, with an escape for any smoke which may enter with the person in passing through the doorway, and which would guard and be the only communication through which every person must pass in going to or from the body of the building on each floor to the stairway. The stair shaft would be furnished with sliding skylights, as are already provided for by the Building Laws of the City of New York, over elevator shafts, the stages of theatres, etc., having a rope extending down the shaft to the bottom, holding the sliding skylights closed, but upon its (the rope's) severance they would immediately open, and thus provide an escape for any smoke which may have found its way into the stair shaft and lock. The same arrangement should apply to the elevator shafts. Smoke locks or check valves may also be placed in the corridors. Persons finding themselves surrounded by smoke, and having the presence of mind to crawl along the floor, keeping their heads as low as possible, would pass the locks or check valves in safety under the most adverse circumstances.

"By this arrangement, perhaps with some modification, every person going to any part of the building above the ground floor or basement would unconsciously pass through the smoke lock; hence the way of escape **via the stairway** would be the **natural** and **familiar** one. Of course the smoke locks, stairways and elevator shafts should be strictly fire-proof. The arrangement throughout would not mar or affect the harmony of the building. Plate glass may be used in the doors or fanlights of the locks, as it would not suffer until after every person had escaped.

"While affording an exit and an escape for the occupants, and while remote from danger, yet in the heart of the building, great facilities would be afforded for the firemen to enter the building and rescue persons, and to fight the fire from a point otherwise unattainable.

"Signs directing strangers to the stairways as a safe exit in case of fire, would be all that would be necessary.

"In hotels, warm dresses may be kept within the smoke locks or stairways for the use of guests not having time to dress themselves, thus avoiding delay, hesitancy and excitement, incident upon going into the street in a night robe. This may be announced upon a printed notice placed in the rooms."



Fig. 179.—City Hall and Court House, Toronto
In which the “Hayes” Patent Lathing was used.



Fig. 180.—Toronto University, Toronto
In which the "Hayes" Patent Lathing was used.



Fig. 181.—Toronto University Library, Toronto

In which the "Hayes" Patent Lathing was used.



Fig. 182.—St. Michael's Hospital, Toronto
In which the "Hayes" Patent Lathing was used.

THE METALLIC ROOFING COMPANY OF CANADA, LIMITED, TORONTO, CANADA.

SOME BUILDINGS IN WHICH THE
"Hayes" Patent Fire-Proof Lathing
HAS BEEN USED.

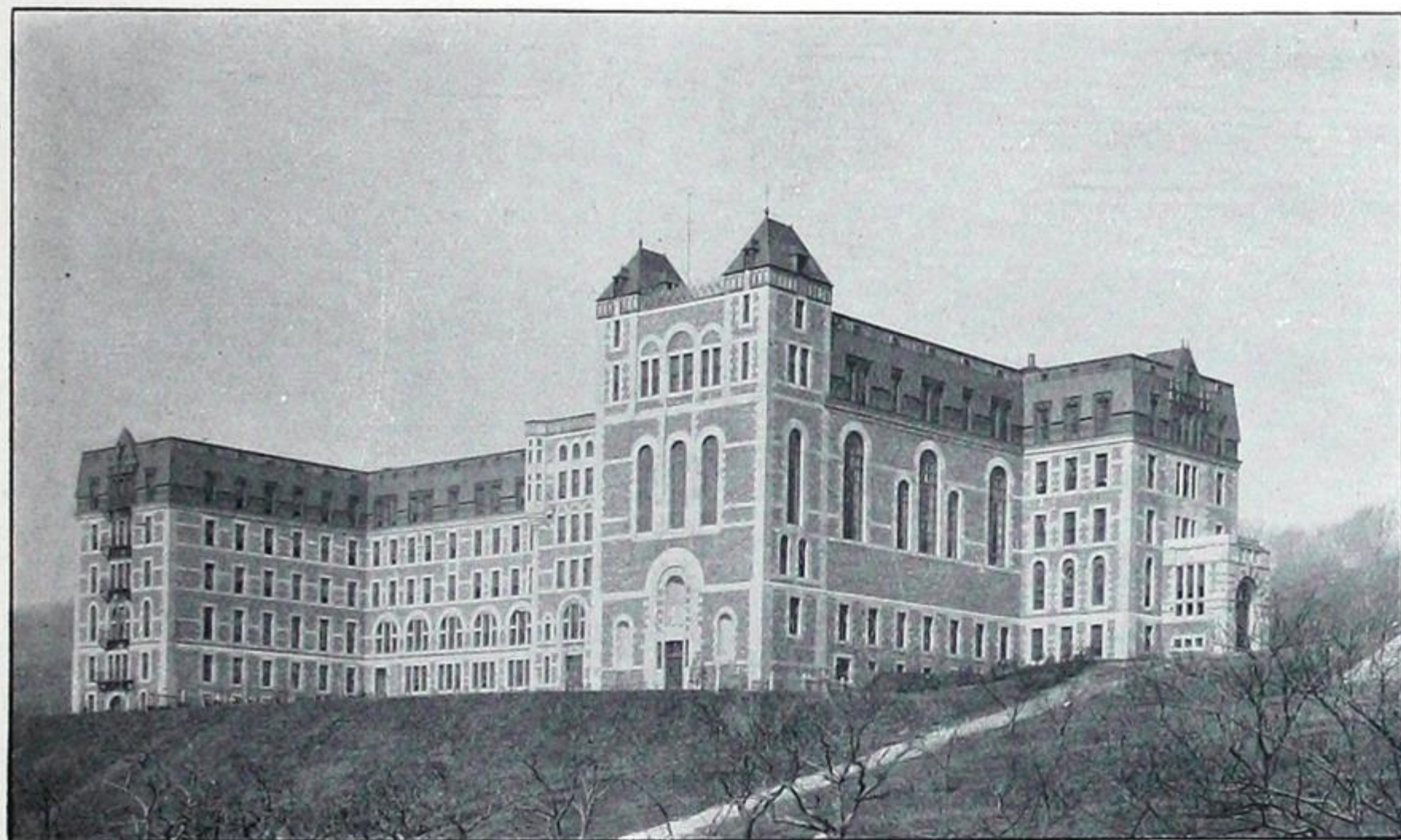

Fig. 183.—Le Grand Seminaire, Montreal.

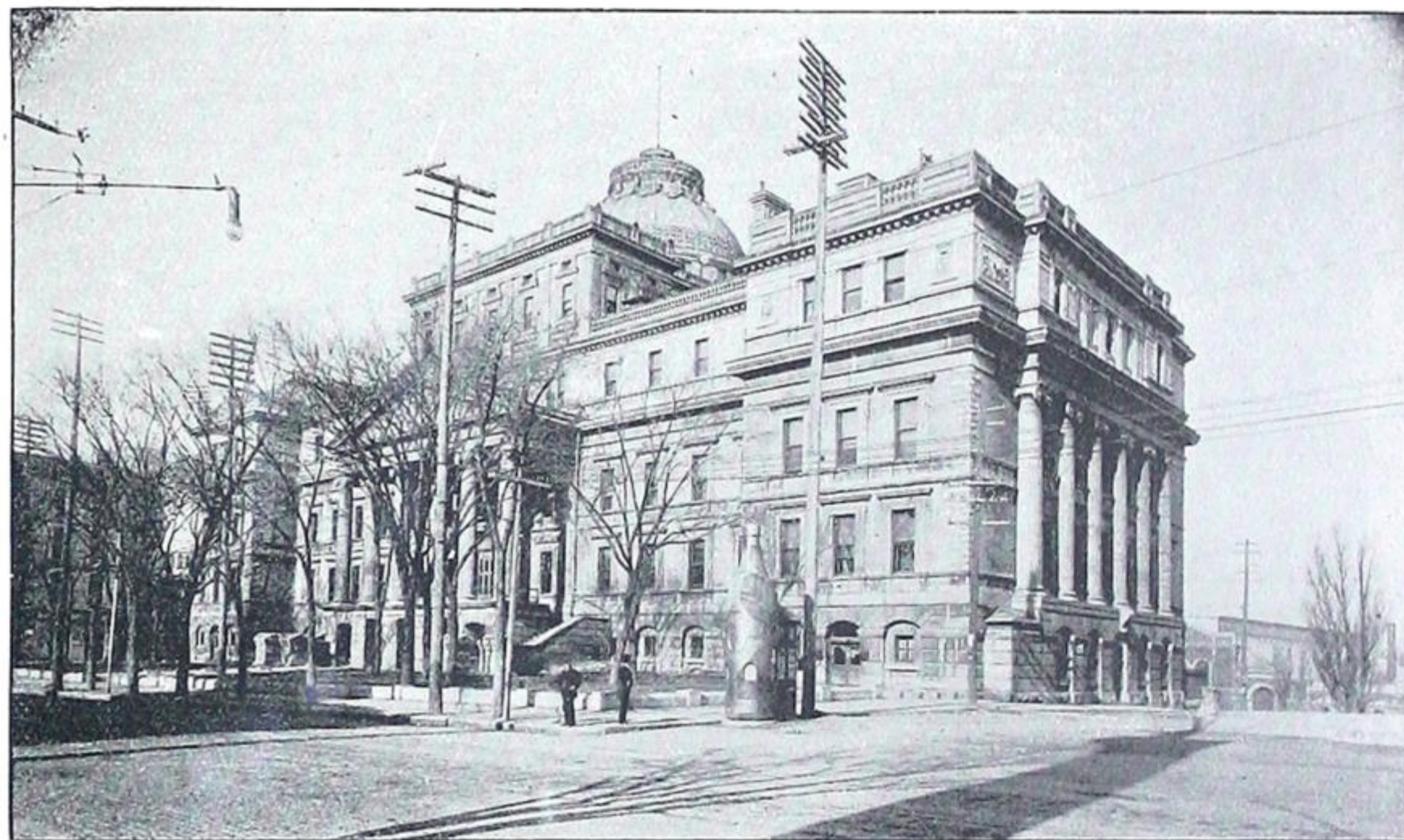

Fig. 184.—Court House, Montreal.

THE METALLIC ROOFING COMPANY OF CANADA, LIMITED, TORONTO, CANADA.

SOME BUILDINGS IN WHICH THE
"Hayes" Patent Fire-Proof Lathing
HAS BEEN USED.



Fig. 185.—Le Monument Nationale, Montreal.



Fig. 186.—Jas. A. Ogilvy & Sons' Store, Montreal.

THE METALLIC ROOFING COMPANY OF CANADA, LIMITED, TORONTO, CANADA.

SOME BUILDINGS IN WHICH THE
"Hayes" Patent Fire-Proof Lathing
HAS BEEN USED.



Fig. 187.—General Hospital, Montreal.



Fig. 188.—Parliament Buildings, Ottawa.

THE METALLIC ROOFING COMPANY OF CANADA, LIMITED, TORONTO, CANADA.

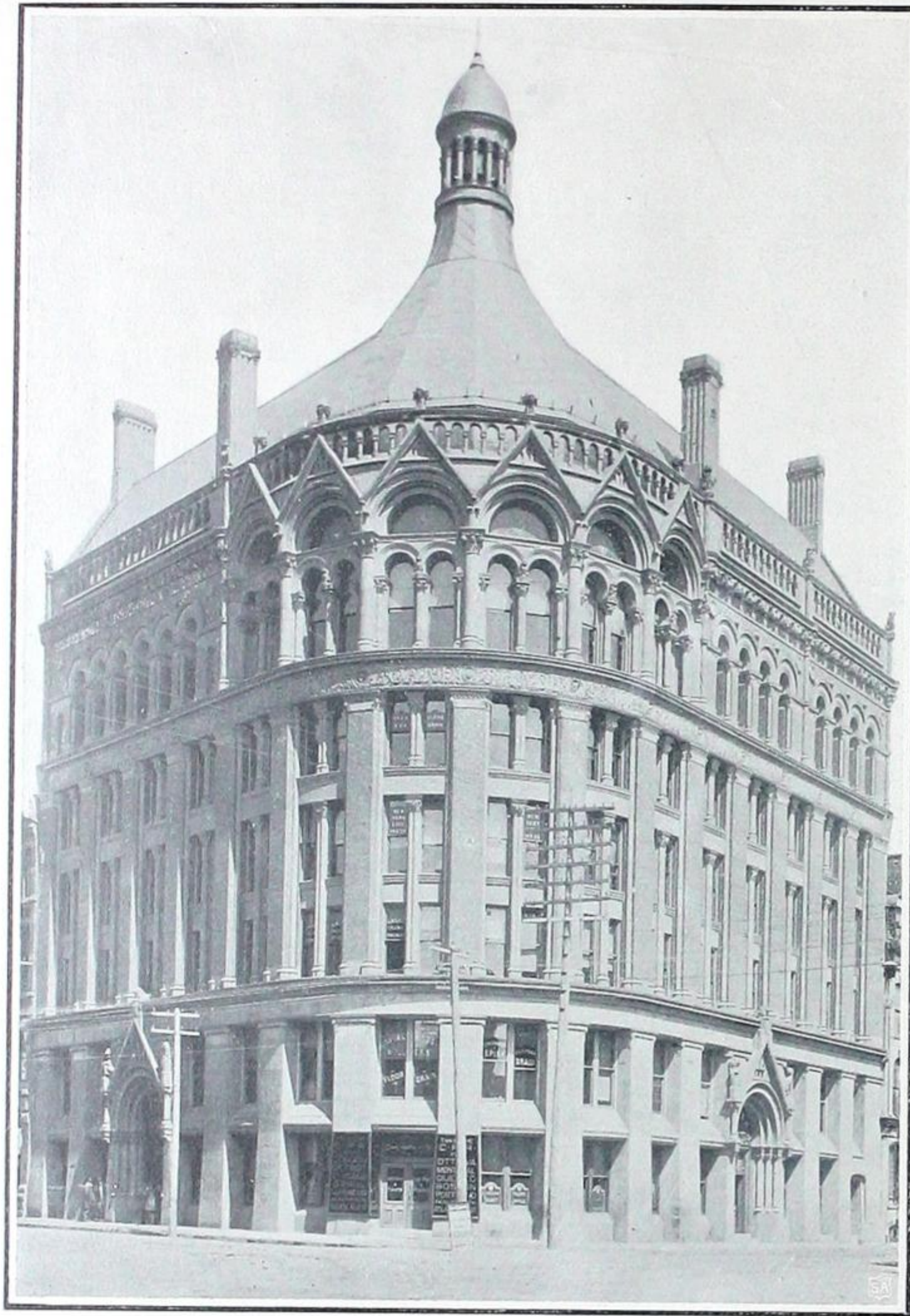

Fig. 189.—Board of Trade, Toronto
In which the "Hayes" Patent Lathing was used.

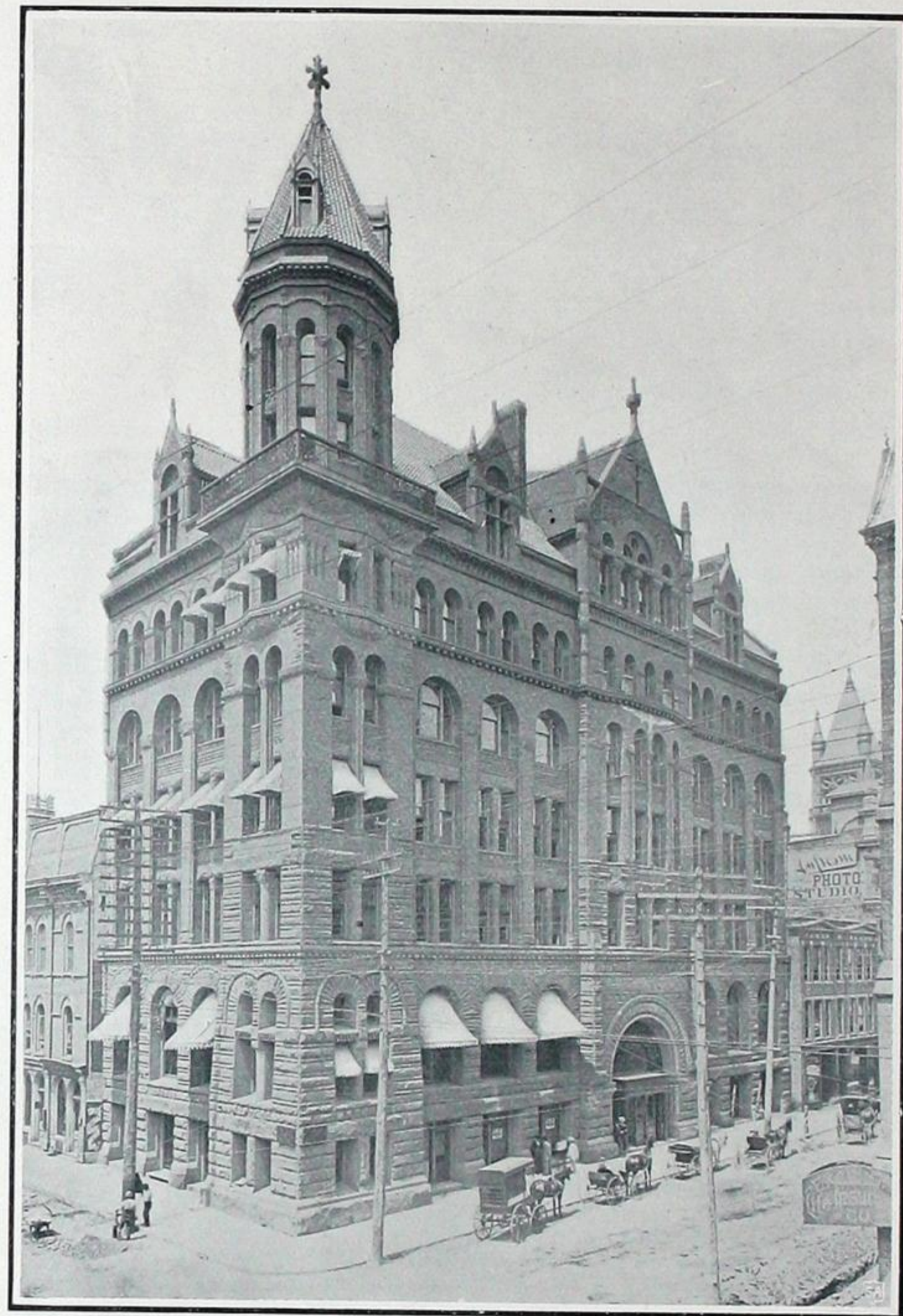

Fig. 190.—Freehold Loan and Savings Company, Toronto
In which the "Hayes" Patent Lathing was used.



Fig. 191.—Union Station, Toronto
In which the "Hayes" Patent Lathing was used.



Fig. 192.—Dominion Bank, Toronto, (Head Office)
In which the "Hayes" Patent Lathing was used.

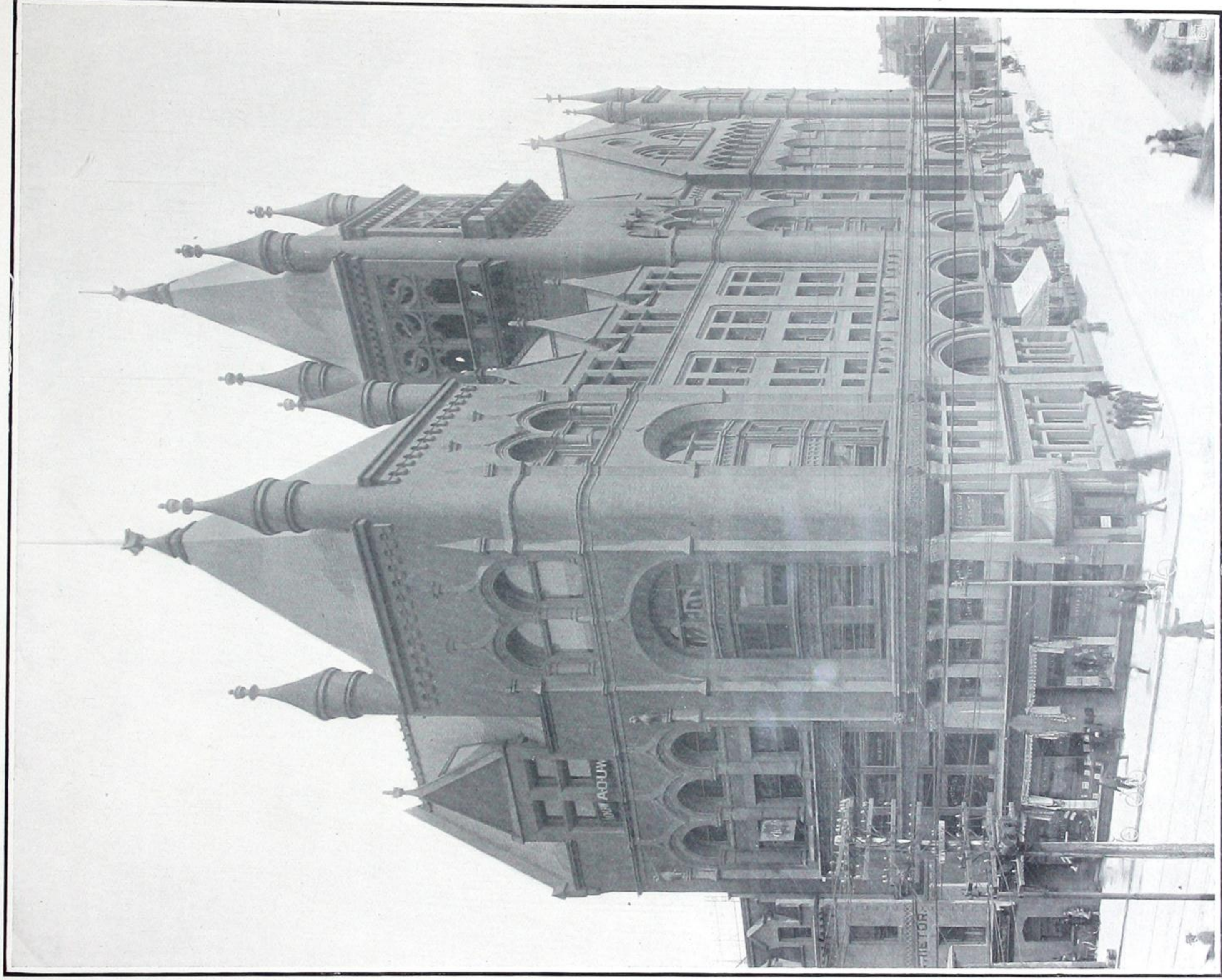

Fig. 193.

Confederation Life Association, Toronto

In which the "Hayes" Patent Lathing was used.

Some Buildings in which the "Hayes" Patent Fire-Proof Lathing has been Used.

Court House, Montreal, Que.	Dominion Bank, (Spadina Avenue Branch), Toronto, Ont.	Bank of Hamilton, Hamilton, Ont.
Monument Nationale, " "	Imperial Bank (Head Office), " "	Royal Hotel, " "
La Banque du Peuple, " "	Freehold Loan Building, " "	Court House, Woodstock, "
Le Grande Seminaire Theologique, " "	Confederation Life Association, " "	Sir Alex. Galt Hospital, Lethbridge, N.W.T.
Queen's Hotel, " "	Board of Trade, " "	Bank of British North America, Vancouver, B.C.
Erskine Church, " "	Young Women's Christian Guild, " "	Town Hall, Port Hope, Ont.
General Hospital, " "	St. Michael's Hospital, " "	Trinity College School, " "
Home for Incurables, " "	Residence, Mrs. Cameron, " "	St. Joseph's Church, Ottawa, "
Peel Street High School, " "	John Kay, Son & Company, Building, " "	Department of Public Works, " "
McGill Model School, " "	Consumers' Gas Company, " "	Collegiate Institute, " "
Sacred Heart Convent, " "	McConkey's Restaurant, " "	Parliament Buildings, " "
Mount Royal School, " "	"Evening Telegram" Building, " "	St. Luke's Hospital, " "
Laval University, " "	Union Station, " "	Kingston Infirmary, Kingston, "
Bell Telephone Building, " "	Robert Simpson Company Store, " "	High School, Aurora, "
St. Patrick's Church, " "	McKinnon Building, " "	Rosamond Woollen Company, Almonte, "
St. Gabriel's Church, " "	Temple " " "	Hiram Walker & Sons' Pala- tial Offices, Walkerville, "
Jas. A. Ogilvy & Sons' Store, " "	Jamieson " " "	Montreal Cotton Company, Valleyfield, Que.
Henry Morgan & Co., Store, " "	Ontario College of Dental Sur- gery, " "	General Hospital, Guelph, Ont.
Residence, Sir Wm. Van Horne, " "	Lawlor Building, corner King and Yonge Streets, " "	St. Joseph's Hospital, " "
" Hector Mackenzie, Esq., " "	Toronto Railway Company Building, " "	Hospital, Sarnia, "
" Duncan McIntyre, Esq., " "	Court House and City Hall, " "	English Church, Amherstburg, "
" R. B. Angus, Esq., " "		Exhibition Main Building, Halifax, N.S.
" Late Sir Hugh Allen, " "		Sun Life Building, Sherbrooke, Que.
Toronto University, Toronto, Ont.		
Toronto University Library, " "		
Dominion Bank (Head Office), " "		

INTERIOR FINISH IN SHEET METAL.

A Modern Practical Substitute, and Infinitely Preferable in every way to Plaster, Wood or any other Inside Finish yet Devised. Suitable for Private Residences, Stores, Opera Houses, Asylums, Hospitals, Schools, Churches, and every description of building.



OUR embossed ceilings are made from annealed steel plate, of the finest quality, and of sufficient thickness to make them rigid and stiff, and so retain their shape. Each part is subjected to a pressure equal to **five hundred tons**, ensuring every detail of the work being brought out. **The joints are perfect and unnoticeable**, in each case becoming part of the general design. The ceilings are all well painted before shipping, receiving a **priming coat** on both sides of **pure white zinc paint**, mixed with pure linseed oil and turpentine, which protects the metal; and after they are up in position they may be decorated in any manner to suit the taste. There is practically no limit to the decoration that may be put on our goods, the embossing and relief affording the decorator unlimited scope for his abilities; or the painting may be of the plainest kind, the lines of light and shade formed by the relief of the ornamentation in themselves constitute an effectual scheme of decoration.

Some designs of plates have deep, raised edges, and these must be laid on furring strips, whether the ceiling is sheeted or not; the others may be laid on sheeting or furring strips, as preferred. In old buildings our ceilings are put up without removing the plaster, being secured to wood furring strips nailed over the plaster through to the joists.

For arched, pointed or groined ceilings, most of the plates may be curved to any desired radius to meet the situation.

Illustrations are photographic reproductions taken from the goods themselves, so that they show them exactly as they are.

If we have a sketch of work to be done, showing exact shape, with accurate measurements and necessary information, we are always glad to submit a sketch showing what treatment we would propose, together with a bulk figure for sufficient material to do the work all complete.

Before ordering or asking for quotations read page 134 carefully. This is very important.

POINTS OF EXCELLENCE WORTH CONSIDERING.

LIGHT IN WEIGHT.
NO DANGER OF FALLING PLASTER.
NO CRACKING NOR DROPPING OFF, LIKE MORTAR.
NO OPENING UP NOR UNSIGHTLY SEAMS, LIKE WOOD.
ACOUSTIC PROPERTIES UNEXCELLED.
NOT INJURED BY WATER. PRACTICALLY FIRE-PROOF.
ARTISTIC IN DESIGN. PERFECTLY SANITARY.
A PERMANENT BASIS FOR DECORATION.
LASTING QUALITIES INDEFINITE.
CAN BE APPLIED BY ANY MECHANIC.

Instructions for Ordering.

IF CUSTOMERS will send us a sketch of the work to be done, showing the exact shape, with accurate measurements marked on it, and mention description of goods required, we lay the work out and send a plan, with the invoice, or for approval before shipping the goods, if so desired. Our plans are carefully drawn to scale, and show distinctly the proper spacing of the furring strips, (where such are used), the location of all of the different parts; and, in cross section, illustrate the method of joining the various cornice, border, mouldings and plates together, making it a very simple matter for any mechanic to put the work up.

It is absolutely imperative, however, that we have accurate measurements (figured dimensions are preferable to simply scale drawings) and the fullest possible information regarding the work to be done. If for a ceiling, send a ceiling plan, not a floor plan, and give exact location of any beams, skylights, chandeliers, stairways, or other offsets or openings, also whether it is intended to apply ceiling to furring strips or sheeting. If a cornice is desired, mention how far it may come down on the walls without interfering with window frames or other woodwork, and where there are stairways, elevator openings, etc., make a note whether the cornice can or cannot finish around same. Sections showing the drop of the different cornices are given opposite the illustrations of same.

For walls, send an elevation of each wall with figured dimensions and showing location of any doors, windows, etc., and give exact height from top of base to ceiling.

Where there are divided measurements on a ceiling or wall, the total lengths and widths should also be given, and all measurements should agree. Where there are any circles, always give exact figured radius.

These are all very important matters, and a little care and attention in ordering will save time and annoyance, and enable us to get results that might not otherwise be obtainable.

In mentioning designs always designate them by their numbers in the Catalogue.

When required, we furnish thoroughly competent workmen to put up, decorate and complete our work in any part of the country, either at so much per day and expenses, or we contract for the work complete.

Customers will please bear in mind that the work has to be laid out to a plan by our draughtsmen after the order is received, even before we can start getting the material ready, therefore **all orders should be placed at least one week before shipment is expected.**

If suitable nails are wanted, mention them on the order.

Special designs made to any detail, prices for which will be quoted on receipt of specifications giving necessary information.

Supports and Furring for Metal Ceilings.

SOME of the designs of ceiling plates require to be laid on furring strips, whether the ceiling is sheeted or not. These plates are so marked under their different numbers in this catalogue. With other designs, where the ceiling is not already sheeted with wood, it will require to be furred with wood strips one inch thick, surfaced on one side, so as to be all of a uniform thickness, and placed the proper distance apart to suit the design, as shown on blue print sent with each ceiling.

Furring strips or sheeting should always be carefully levelled up with small wooden wedges, so as to present a perfectly level and smooth surface on which to apply the metal.

Where ceilings are plastered, the furring strips are placed on top of the plaster and nailed with three-inch nails through to the joisting, without disturbing the plaster.

Walls should always first be sheeted with wood, surfaced on one side to an even thickness. Cull lumber is quite suitable, so long as it is reasonably seasoned and sound.

The proper spacing of furring strips is always shown on blue print sent with each ceiling, where we lay the work out, and must be adhered to.

Directions for Applying Metal Ceilings.

CEILING PLATES LAID DIAGONALLY.

First Consult Plan Carefully.

FIRST put up cornice, border and mouldings (where such are used), all around room, overlapping the lengths **from the light**, to make the pattern match perfectly.

Our plans show in cross section the method of uniting the cornice, border and mouldings together, and this must be carefully followed out.

Commence laying centre field plates, by first finding the exact centre of ceiling and drawing a line through that point lengthwise of room, and another through the same point, at right angles to the first line. Then put up first plate so that all four corners of it will touch these lines, and work in all four directions from that point, so that the pattern will finish the same up against the moulding on the two sides of room, and the same on the two ends of room.

Our plans always show in cross section the method of joining the plates together. (See also pages 137, 138 and 139.) In most cases with plates laid diagonally the beads do **not** overlap each other, but the beads on the two squared edges of each sheet overlap the plain flanges and butt up against the beads on the adjoining sheets. Metal Ceiling Plates should always be laid **from the light**, that is, the plate nearest where the light enters the room should overlap the adjoining sheet. In this way all **joints are from the light** and are not noticeable.

Where plates are cut on the job, we always figure that all pieces will be worked in. That is, if there is a corner comes off a plate and there is sufficient stock in it by trimming it down to work in somewhere else, we figure that this will be done, and only send material accordingly.

Directions for Applying Metal Ceilings.

CEILING PLATES LAID SQUARE.

First Consult Plan Carefully.

COMMENCE laying centre field plates at back end of room furthest from the light, at a point that will allow the border to be the same width on the two sides of room, and the same width on the two ends of room, as indicated on plan. Lay the courses so that the plate nearest the light overlaps the adjoining one, using the proper joint as shown on plan. In this way **all joints** are **from the light** and are not noticeable. The moulding between the centre field and the border has to be put up at the same time as the plates, as the flange of it goes under the centre field plates. Some plates are made with just two beaded edges, which are squared, and the squared edges of each sheet always overlap the plain edges so that the design will be completed when put together. Other designs have squared edges all around and either side may be the overlapping one.

The proper joints of all plates are always shown in cross section on our plans. (See also pages 137, 138 and 139.)

After the centre-field is in position, put on the cornice and mouldings, overlapping the lengths **from the light** to make the pattern match perfectly. Then fill in the remaining space between the two rows of mouldings with the border.

WALL DESIGNS.

Commence putting on plates at the top of wall next the ceiling, running the courses across the space and working downwards. All plates should be laid so that the side lap joints are **from the light**. The top edge of the lower course overlaps the bottom edge of the upper course, unless there is a joint below the line of vision, in which case the upper sheet would be the overlapping one.

NAILING.

Plates Nos. 413, 431, 432, 433, 434, 435, 436, 437, 438, 439, 440, 441, 442, 443, 444, 445, 446, 476, 477, 482, 483, 484, 485, 486, 487, 801, 805, 806, 809 and 815 should be nailed in the exact centre of each of the small button finishes, with $1\frac{1}{8}$ -inch 14-gauge cone-headed wire nails. This completes the design. Plates Nos. 405, 406, 407, 408, 409, 410, 411 and 478 should also be nailed with these cone-headed nails in the small indentations stamped in the beads.

For all other designs use 1-inch 16-gauge wire nails.

For single flange mouldings use $1\frac{1}{2}$ -inch 16-gauge wire nails.

GENERAL.

Intersections of cornices, borders and mouldings should be neatly mitred, where stop blocks or stamped mitres are not used. In mitring an embossed design the pattern should always be cut to mitre with the pattern on the adjoining sheet. Care should be taken that all lines are kept perfectly straight and true, and that all joints are properly made.

Where we lay the work out it is necessary that our plan be strictly adhered to, as any alteration made may necessitate the rearrangement of the whole design.

Sections of Joints. (Full Size.)

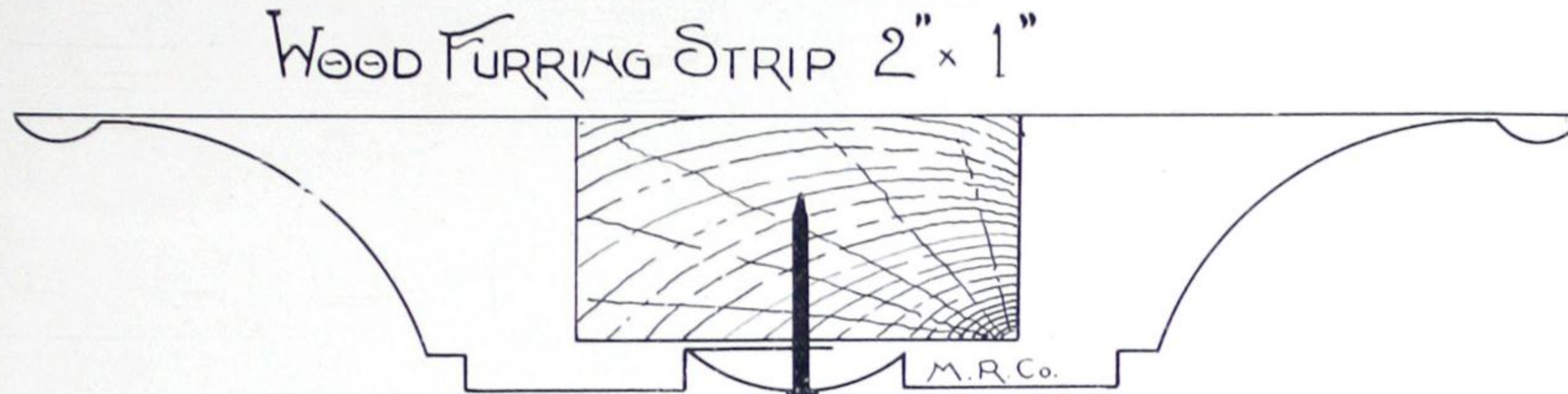

Fig. 3400.—Section of Joint on Plates Nos. 400, 401, 402, 403, and 479.

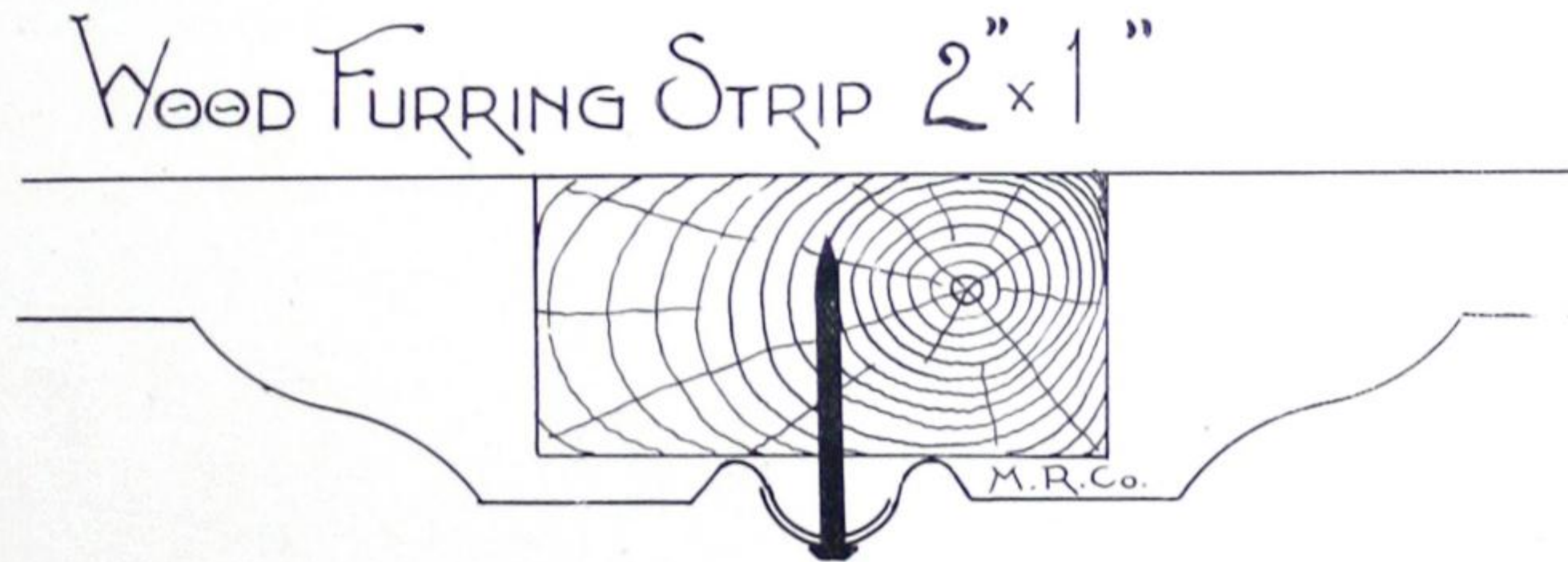

Fig. 3401.—Section of Joint on Plates Nos. 405, 406, 407, 408, 409, 410, 411, 415 and 478.



Sections of Joints. (Full Size.)

WOOD FURRING STRIP 2" x 1"

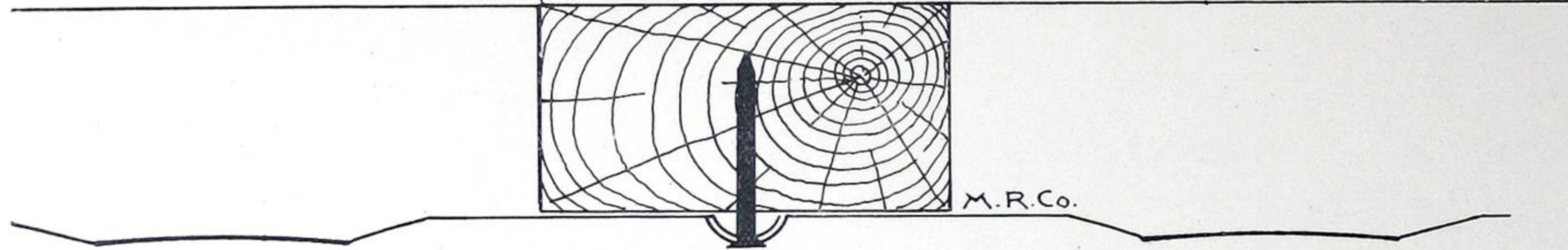

Fig. 3403.—Section of Joint on Plates Nos. 417, 488, and 489.

WOOD FURRING STRIP 2" x 1"

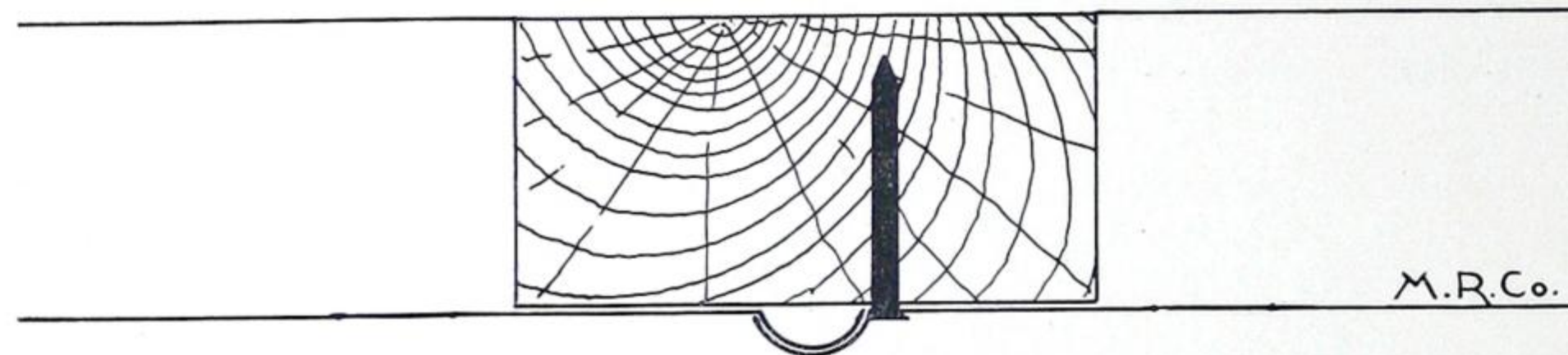

Fig. 3404.—Section of Joint on Plate No. 423.

WOOD FURRING STRIP 2" x 1"

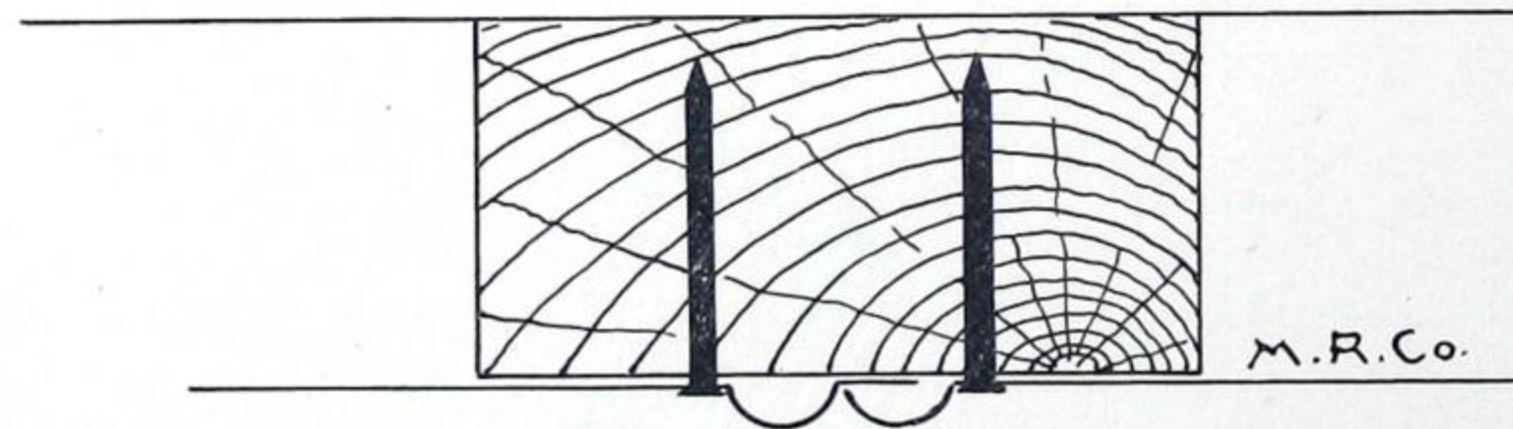

Fig. 3405.—Section of Joint on Plates Nos. 419, 420, 421, 425, 426, 427, 428, 429, and 430.



Sections of Joints. (Full Size.)

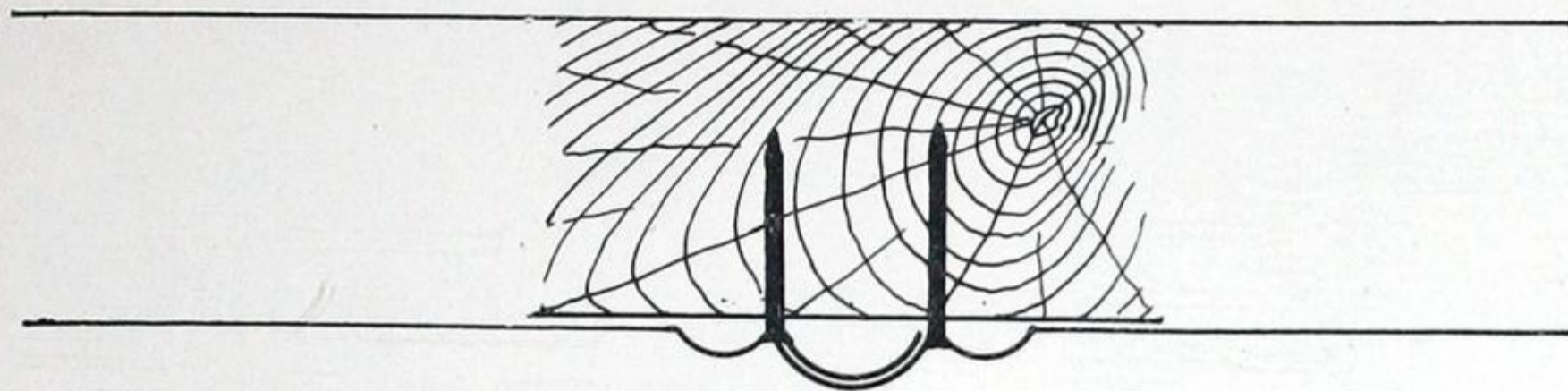

Fig. 3406.—Section of Joint on Plates Nos. 454, 455, 456, 457, 458, and 459.



Fig. 3407.—Section of Joint on Plates Nos. 416 and 422.

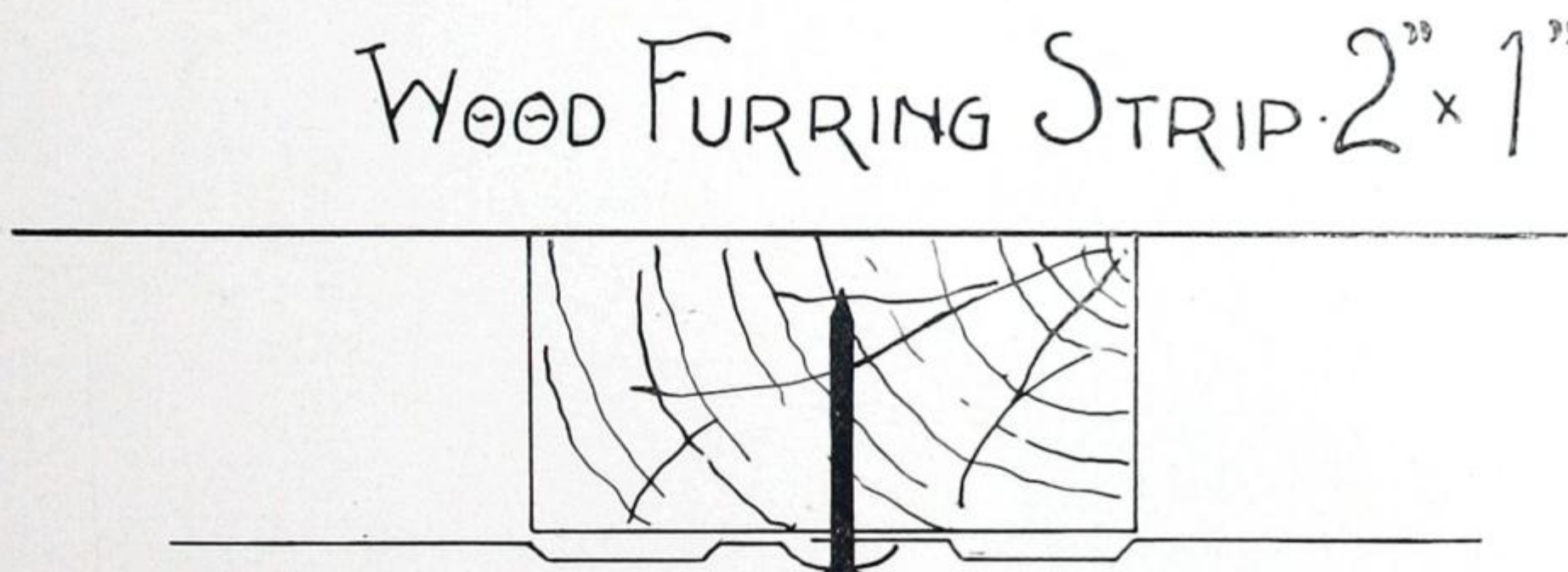

Fig. 3408.—Section of Joint on Plate No. 424.

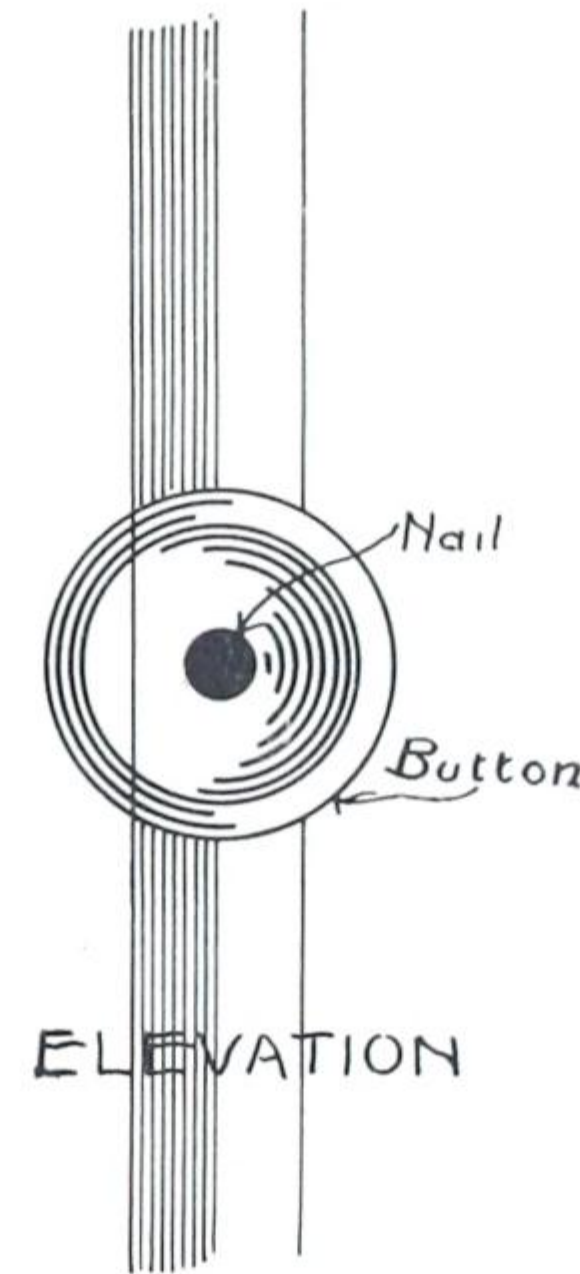
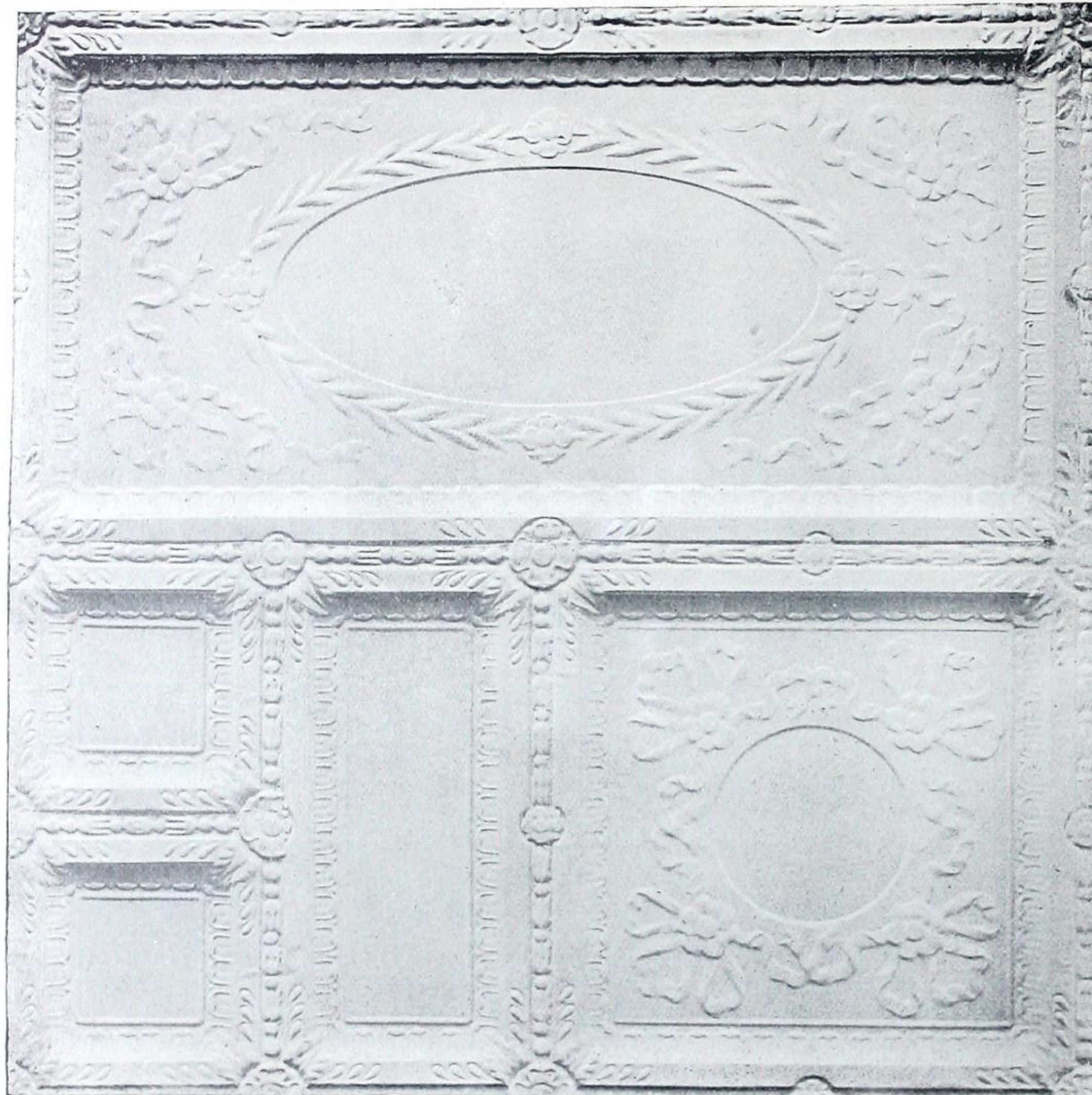

Fig. 3409.—Section of Joint and elevation, showing button finish on Plates Nos. 413, 431 to 446 inclusive, 476, 477 and 482 to 487 inclusive; Cove No. 301; Friezes Nos. 801, 806, and 815.

Always use cone-headed wire nails for all these plates.



Deep Ceiling Plates.

“EMPIRE” OR “COLONIAL”
STYLE.

Require to be laid on furring strips.

Plate No. 400,	covering	24 x 48 ins.,	1 in. deep.
“ No. 401,	“	24 x 24 “	1 “
“ No. 402,	“	12 x 24 “	$\frac{7}{8}$ “
“ No. 403,	“	12 x 12 “	$\frac{7}{8}$ “

These Plates may be used separately or in combination.

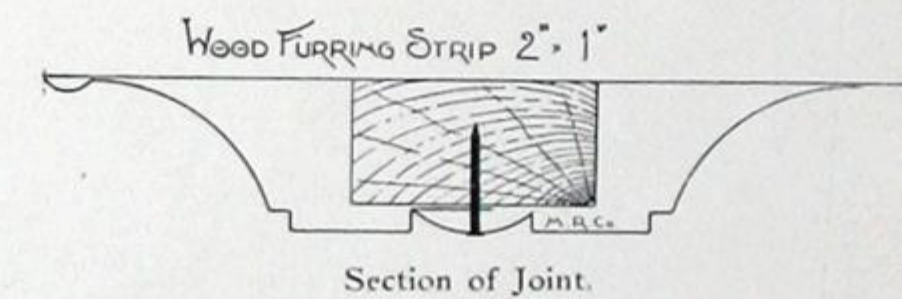



Deep Ceiling or Centre Plate.

“EMPIRE” OR “COLONIAL” STYLE.

Plate No. 404.

Forty-eight by forty-eight inches, one inch deep.

Centrepiece for Plates Nos. 400, 401; or without the mouldings on the edge as a centrepiece for other plates. Also suitable for entire ceilings.

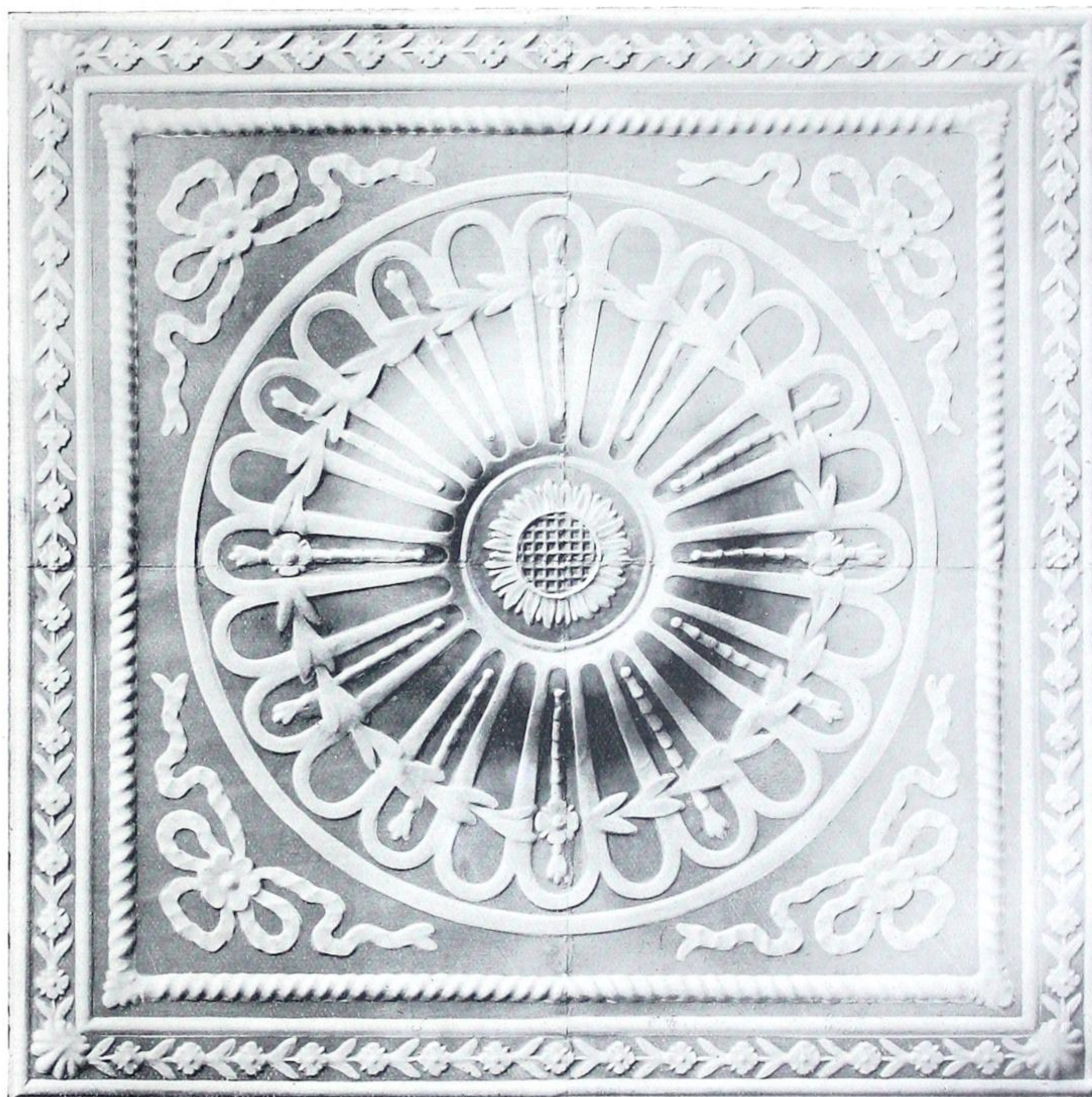

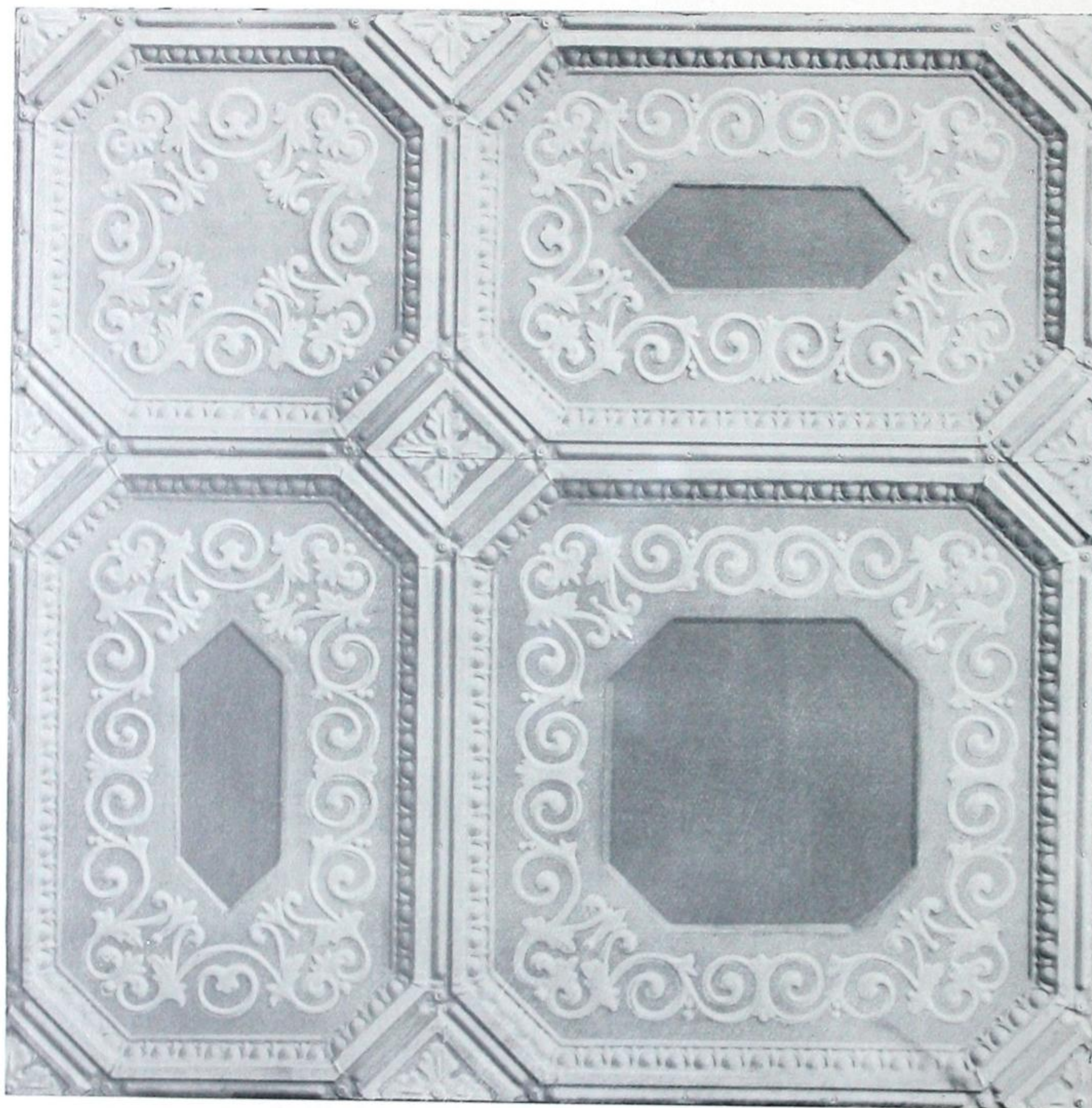

Deep Ceiling Plates.

COMBINATION DESIGN.

Require to be laid on furring strips, two inches wide.

Plate No. 405, covering 27 x 27 ins., $\frac{5}{8}$ in. deep.
" No. 406, " 18 x 27 " $\frac{5}{8}$ "
" No. 407, " 18 x 18 " $\frac{5}{8}$ "

These Plates are all of similar design, with raised seams and sunken panels, and may be laid separately or in combination. The nails are not noticeable, being driven in small indentations in the beads which ornament and conceal the seam.

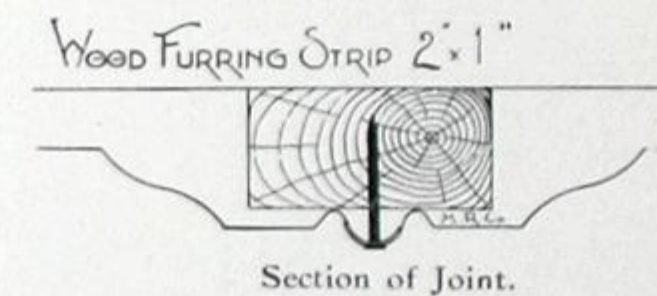

Deep Ceiling Plates.

COMBINATION DESIGN.

Require to be laid on furring strips, two inches wide.

Plate No. 408, covering 27 x 27 ins., $\frac{3}{4}$ in. deep.

“ No. 409, “ 19 x 27 “ $\frac{3}{4}$ “

“ No. 410, “ 19 x 19 “ $\frac{3}{4}$ “

These plates are all of similar design, and may be laid separately or in combination. The nails are driven in small indentations stamped in the bead and become part of the design.

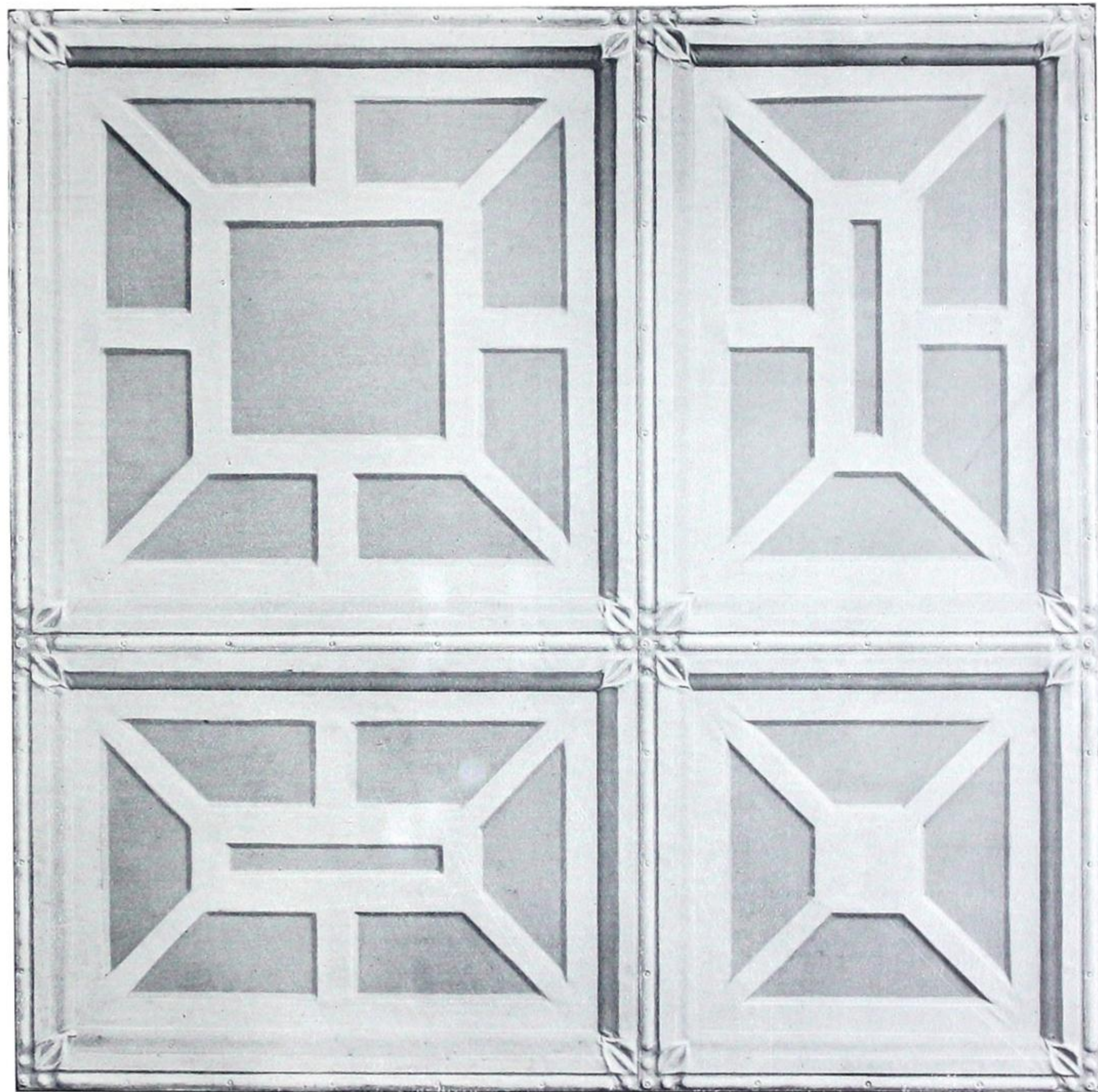
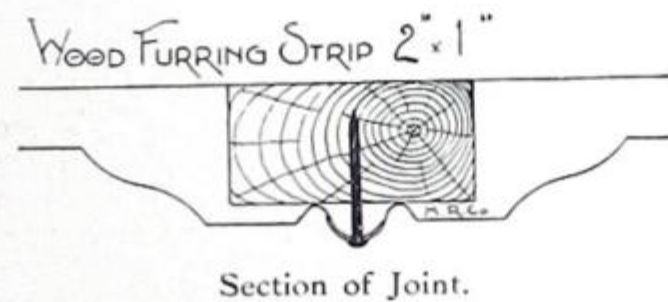

Deep Ceiling Plates.

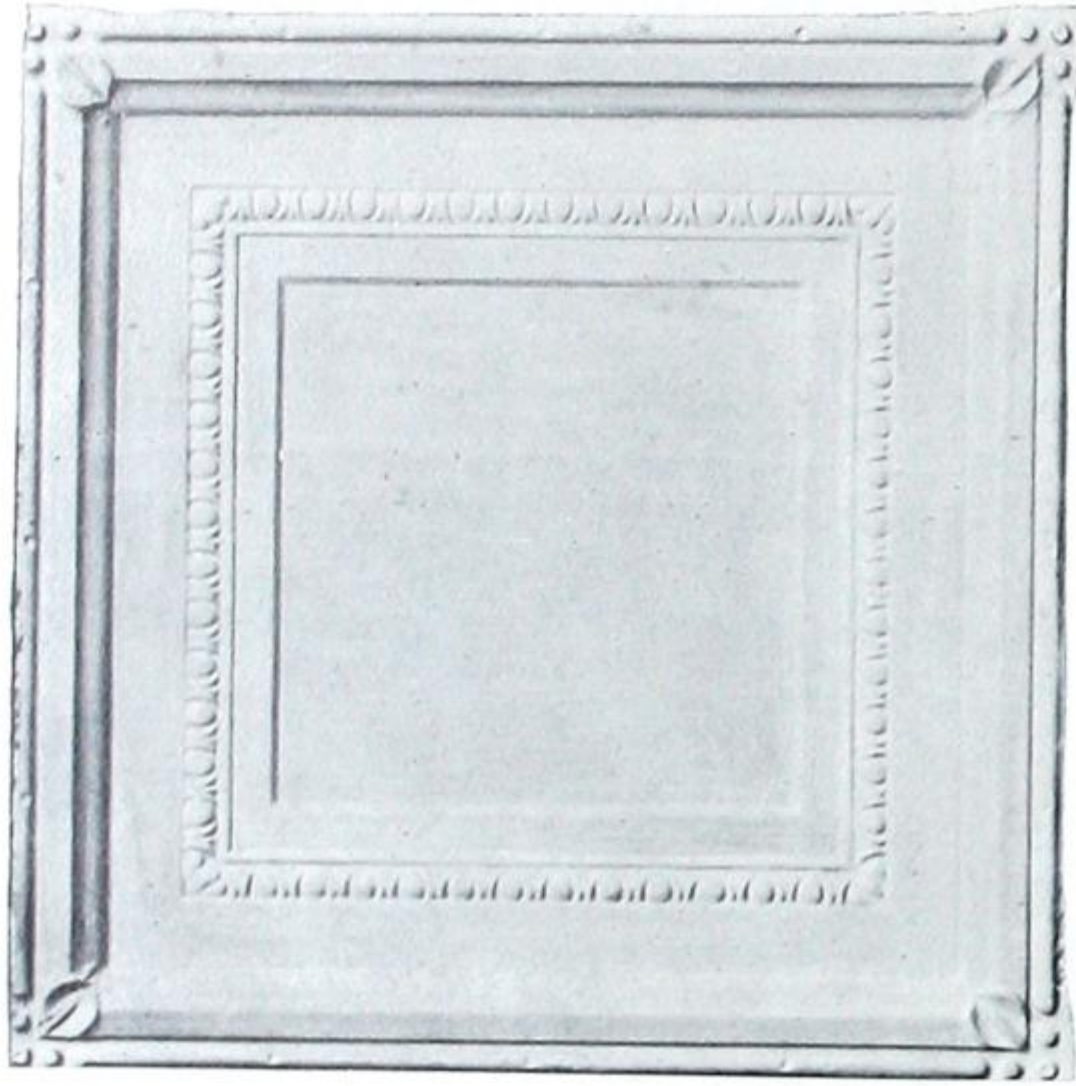
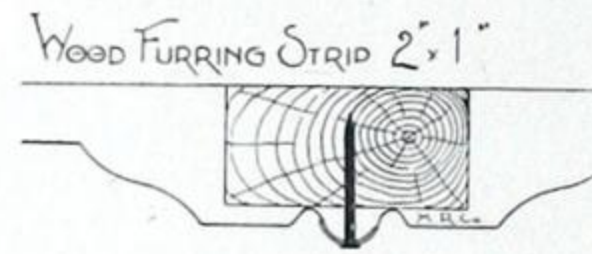

Plate No. 411.

Covering 24 x 24 inches, $1\frac{1}{8}$ inches deep.

Requires to be laid on furring strips.



Section of Joint of Plates Nos. 411 and 415

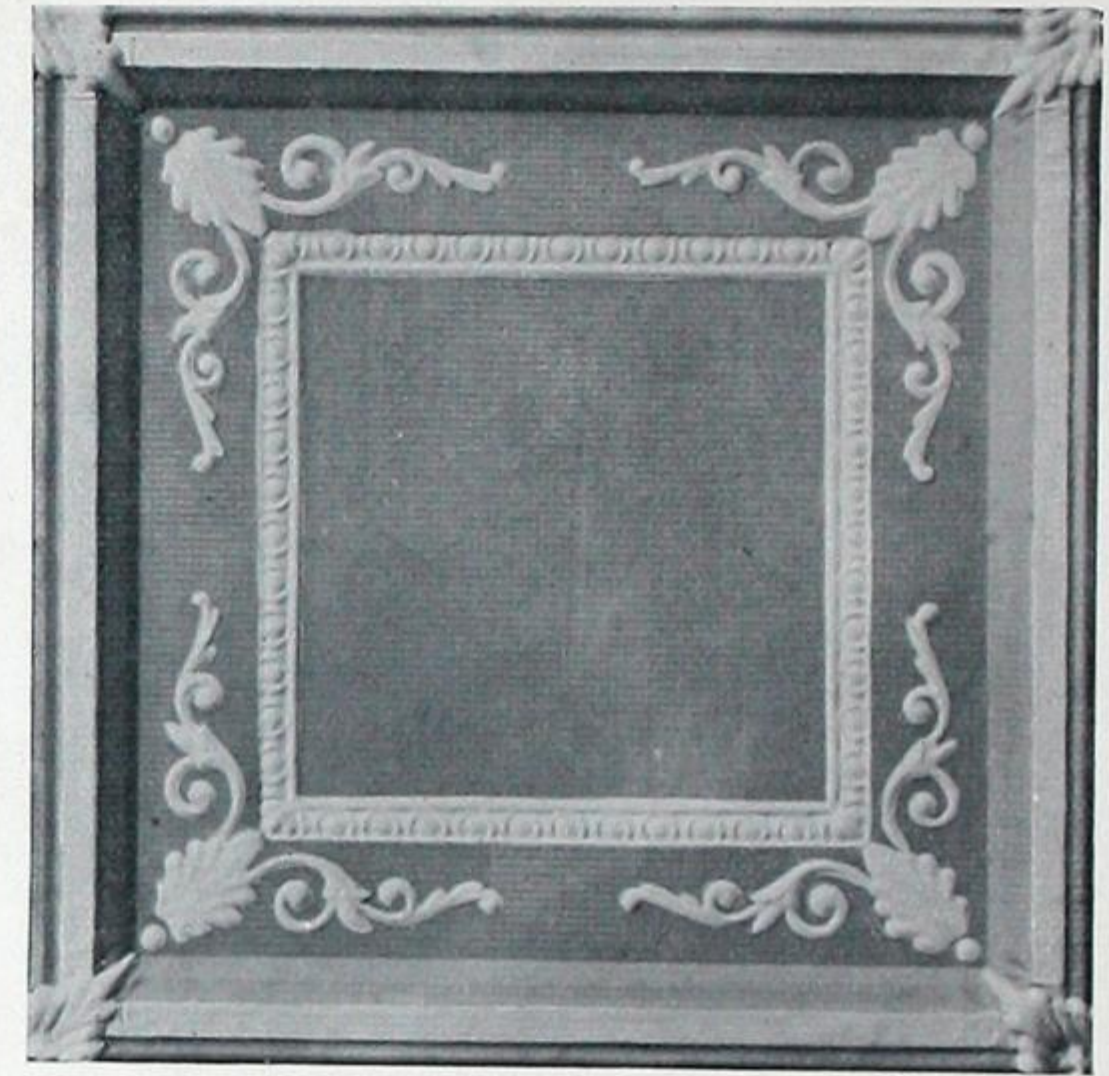

Plate No. 415.

Covering $25\frac{1}{2}$ x $25\frac{1}{2}$ inches, 1 inch deep.

Requires to be laid on furring strips.

“ENGLISH RENAISSANCE” DESIGN.



Plate No. 416.

Covering 27 x 27 inches.

See also Fig. 3008.

“ELIZABETHAN” DESIGN.

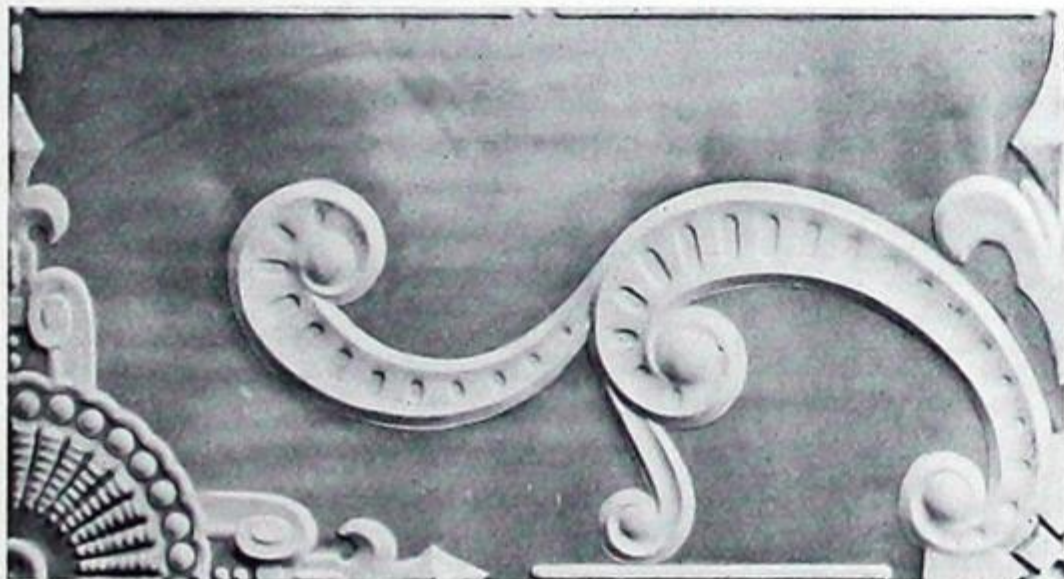
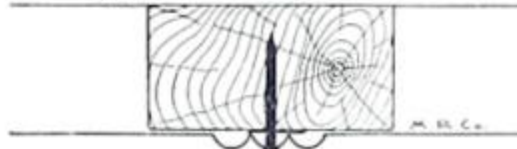

Plate No. 488.—Covering 13 x 24 inches. Used with Plate No. 489, or as a combination with Plate No. 417, see Fig. 3105.

Ceiling Plates.

FURRING STRIP 2" x 1"



Section of Joint of Plate No. 416.

“ELIZABETHAN” DESIGN.



Plate No. 417.—Especially suitable for covering large rooms or high ceilings. Covering 24 x 24 inches. Design is 4 x 4 feet when completed, see Fig. 3000.

Also used in combination with Plates Nos. 488 and 489, see Fig. 3105.

“ELIZABETHAN” DESIGN.



Plate No. 489.—Covering 13 x 24 inches. Used with Plate No. 488, or as a combination with Plate No. 417, see Fig. 3105.

WOOD FURRING STRIP 2" x 1"



Section of Joint of Plates Nos. 417, 488 and 489.

Ceilings and Walls.

"FLEUR DE LIS."



Plate No. 412.

Made in sheets 24 inches wide, and any length up to eight feet. Suitable for walls or ceilings.

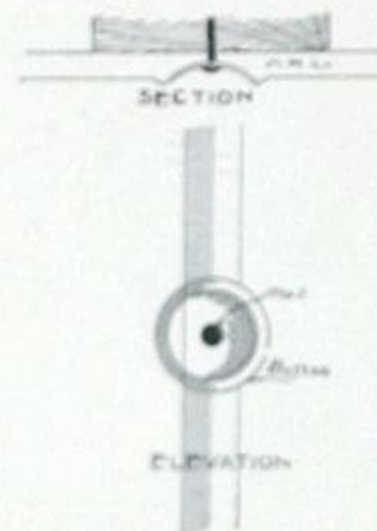

Section and Elevation of Joint
of Plate No. 412.

"FLEUR DE LIS."



Plate No. 418.

Made in sheets 29½ inches wide, and any length up to eight feet; size of flower 7 x 10 inches. Suitable for walls or for the pitched and Gothic ceilings of churches, halls, etc.

Ceilings and Walls.

"LOUIS XVI" DESIGN.

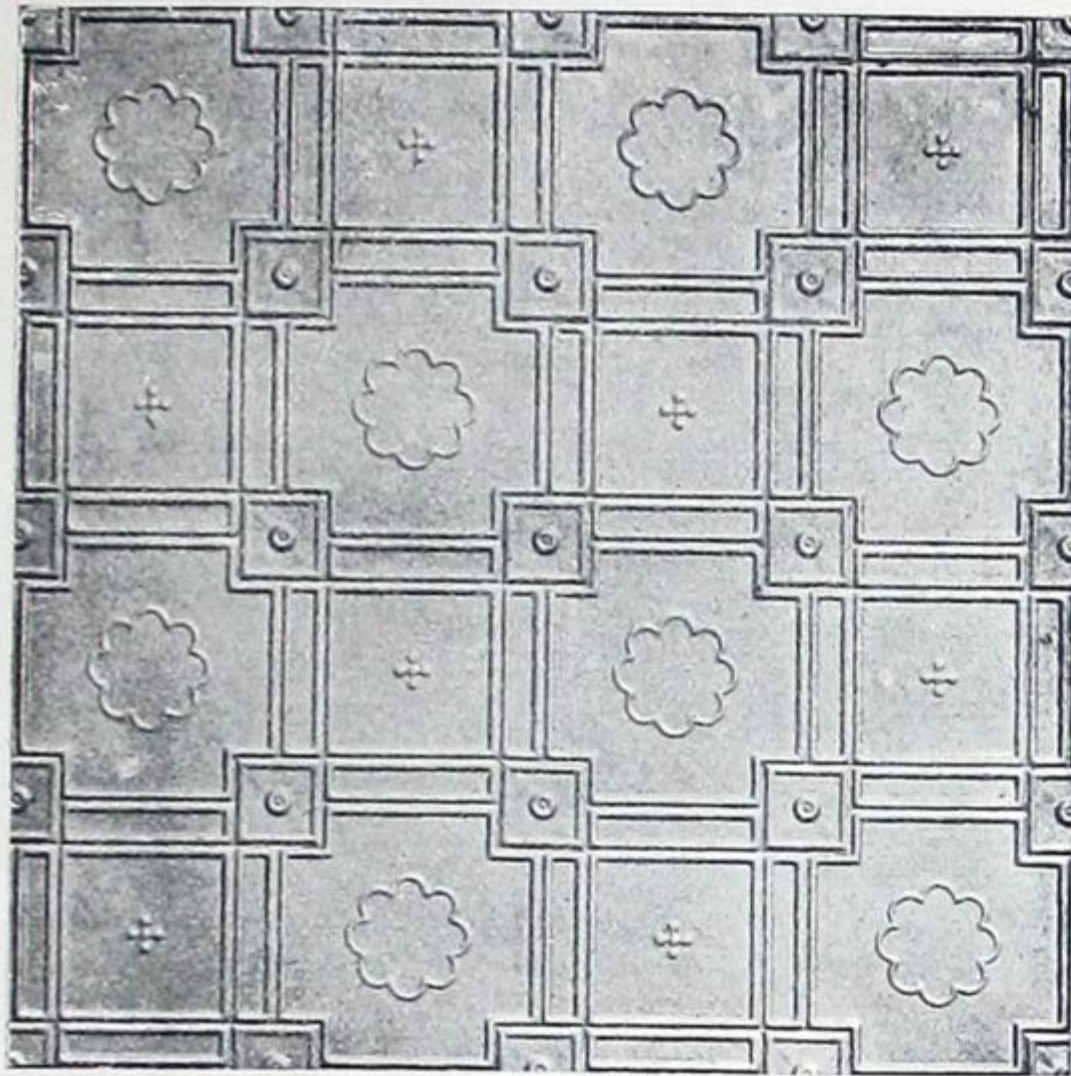
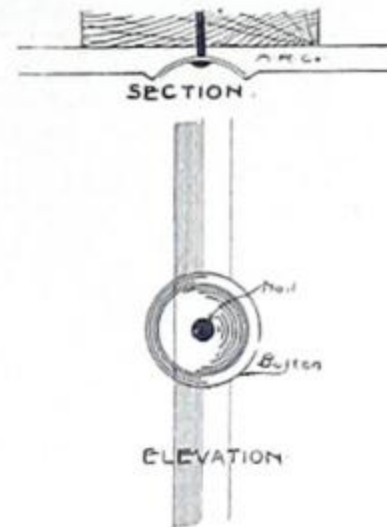

Plate No. 413.
Covering 24 x 24 inches. For ceilings or walls.



Section and elevation of Joint
of Plate No. 413.



Plate No. 419.
Covering 23 1/4 x 23 1/4 inches.

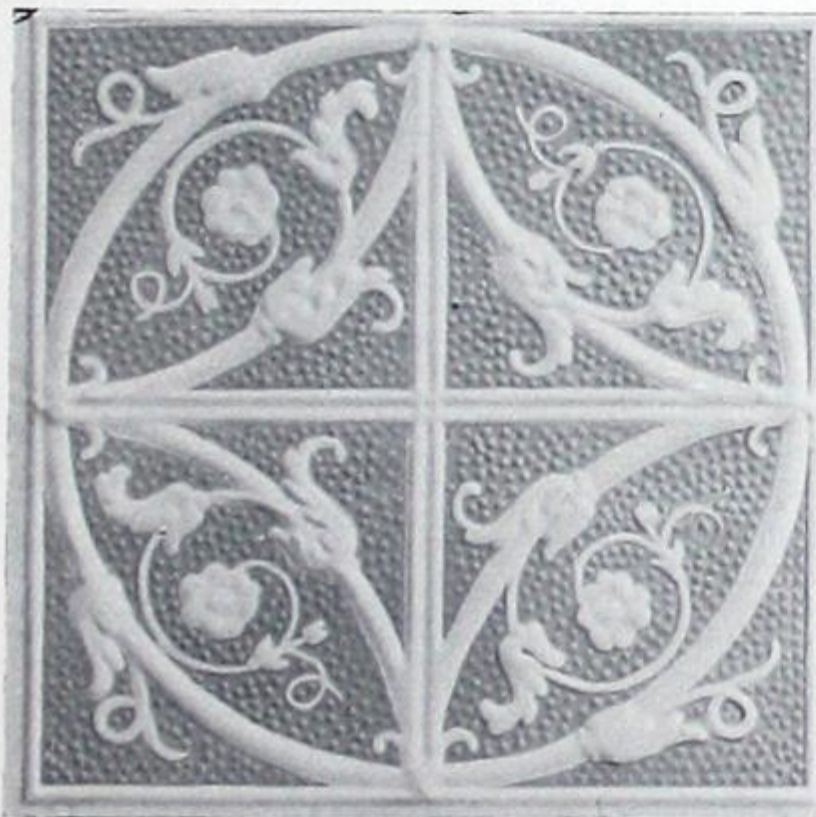

Plate No. 420.—Covering 19 1/2 x 19 1/2 inches.



Section of Joint on Plates Nos. 419, 420, 421.

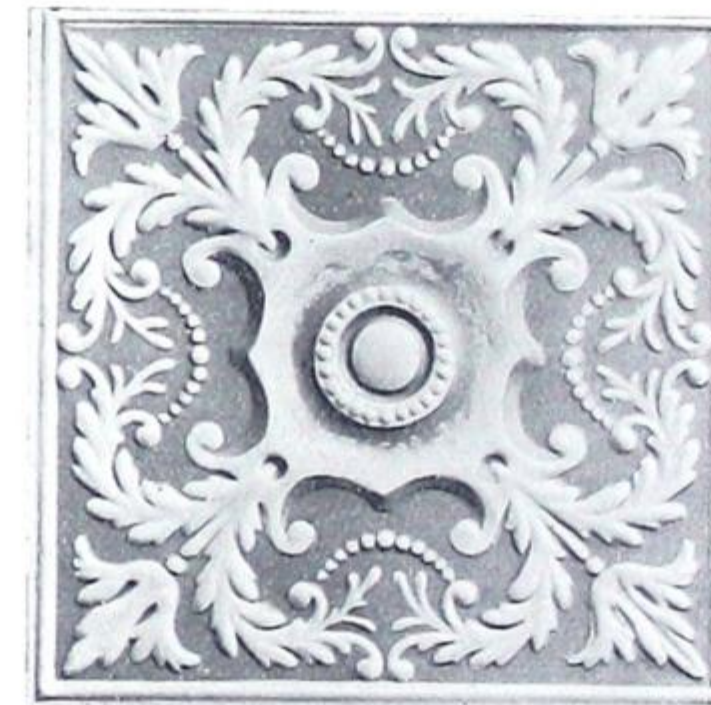

Plate No. 421.—Covering 13 1/2 x 13 1/2 inches.
Design Registered 1898.

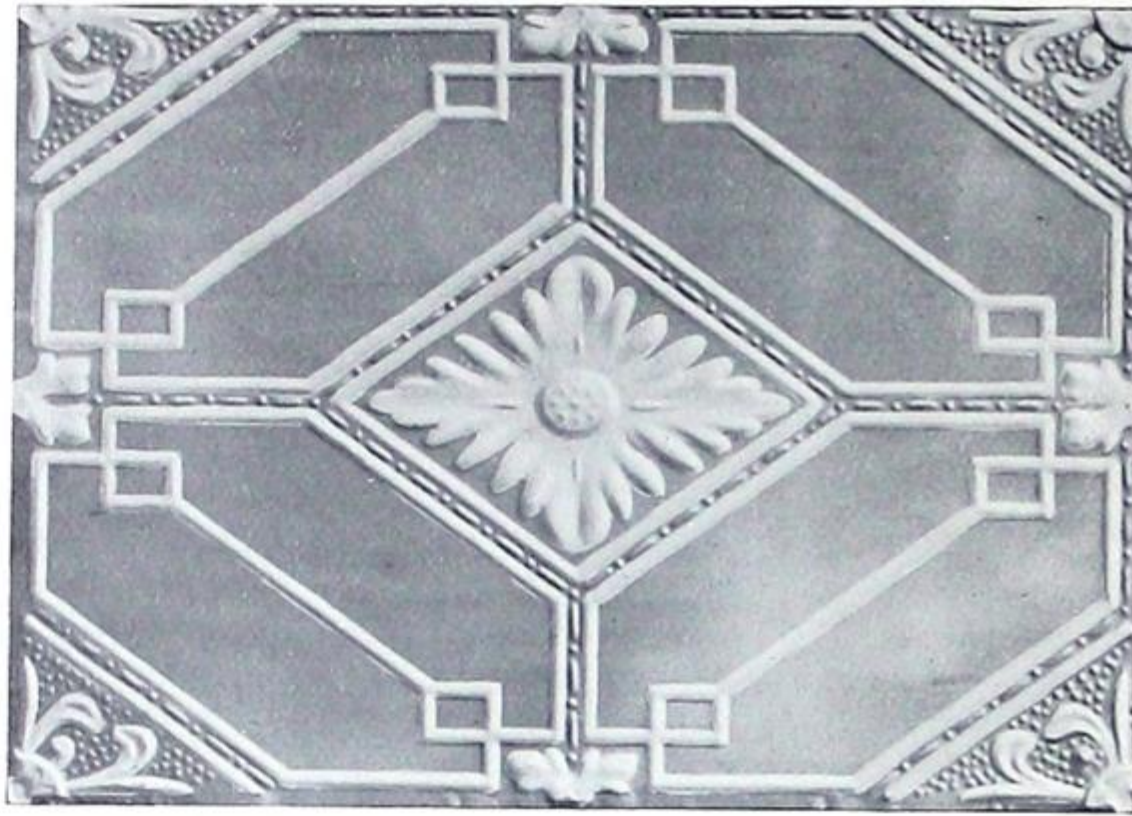

Plate No. 422.—Covering 19½ x 27½ inches.

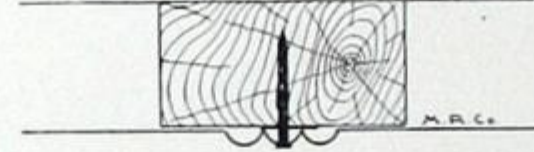

Plate No. 423.—Covering 23 x 35 inches.



Plate No. 424.—Covering 24 x 24 inches.

FURRING STRIP 2" x 1"



Section of Joint of Plate No. 422.

WOOD FURRING STRIP 2" x 1"



Section of Joint of Plate No. 423.

WOOD FURRING STRIP 2" x 1"



Section of Joint of Plate No. 424.

Ceiling Plates.

GRAPE VINE.

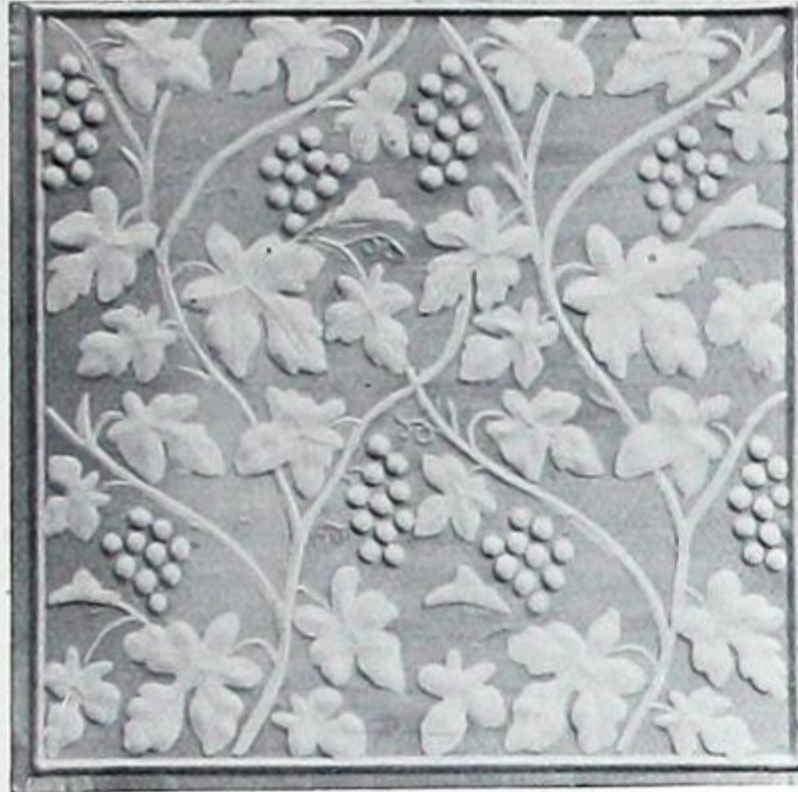

Plate No. 425.—Covering 19 x 19 inches.

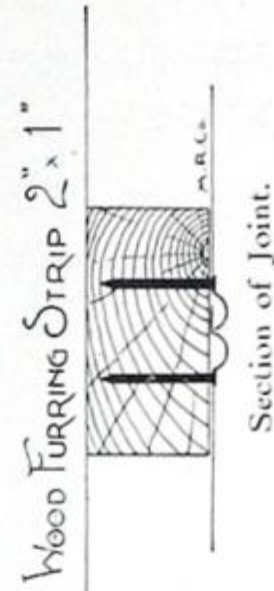

Plate No. 426.—Covering 19 x 19 inches.

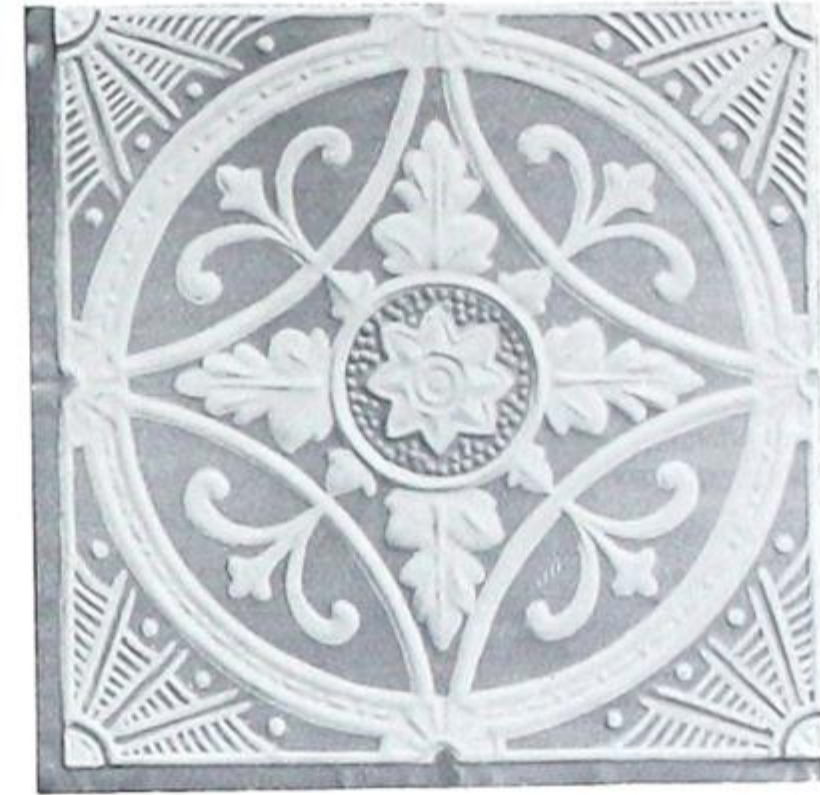

Plate No. 427.—Covering 19 x 19 inches.

“JAPANESE” DESIGN.



Plate No. 428.—Covering 23 x 23 inches.



Plate No. 429.—Covering 19 x 19 inches.

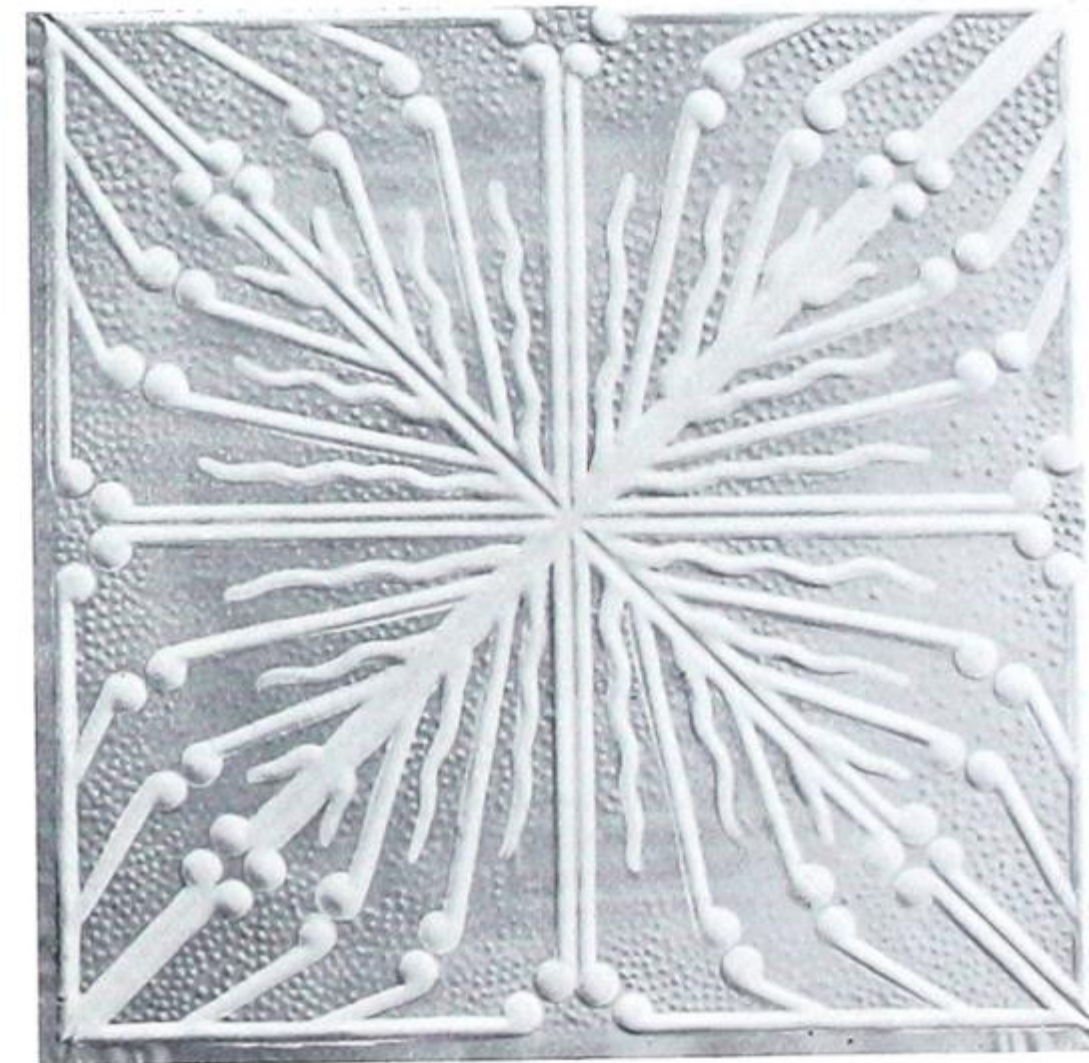

Plate No. 430.—Covering 23 x 23 inches.



Plate No. 431.

Covering 24 x 24 inches, $2\frac{3}{8}$ inches deep. Generally used as a centrepiece.



Plate No. 433. Covering 24 x 24 inches. Heavily embossed, for high ceilings.

Ceiling and Wall Plates.

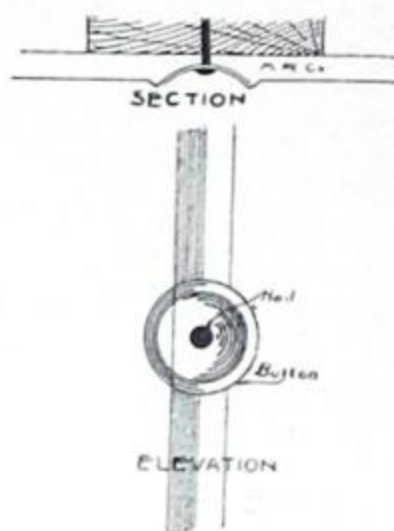

Section and Elevation of Joint.

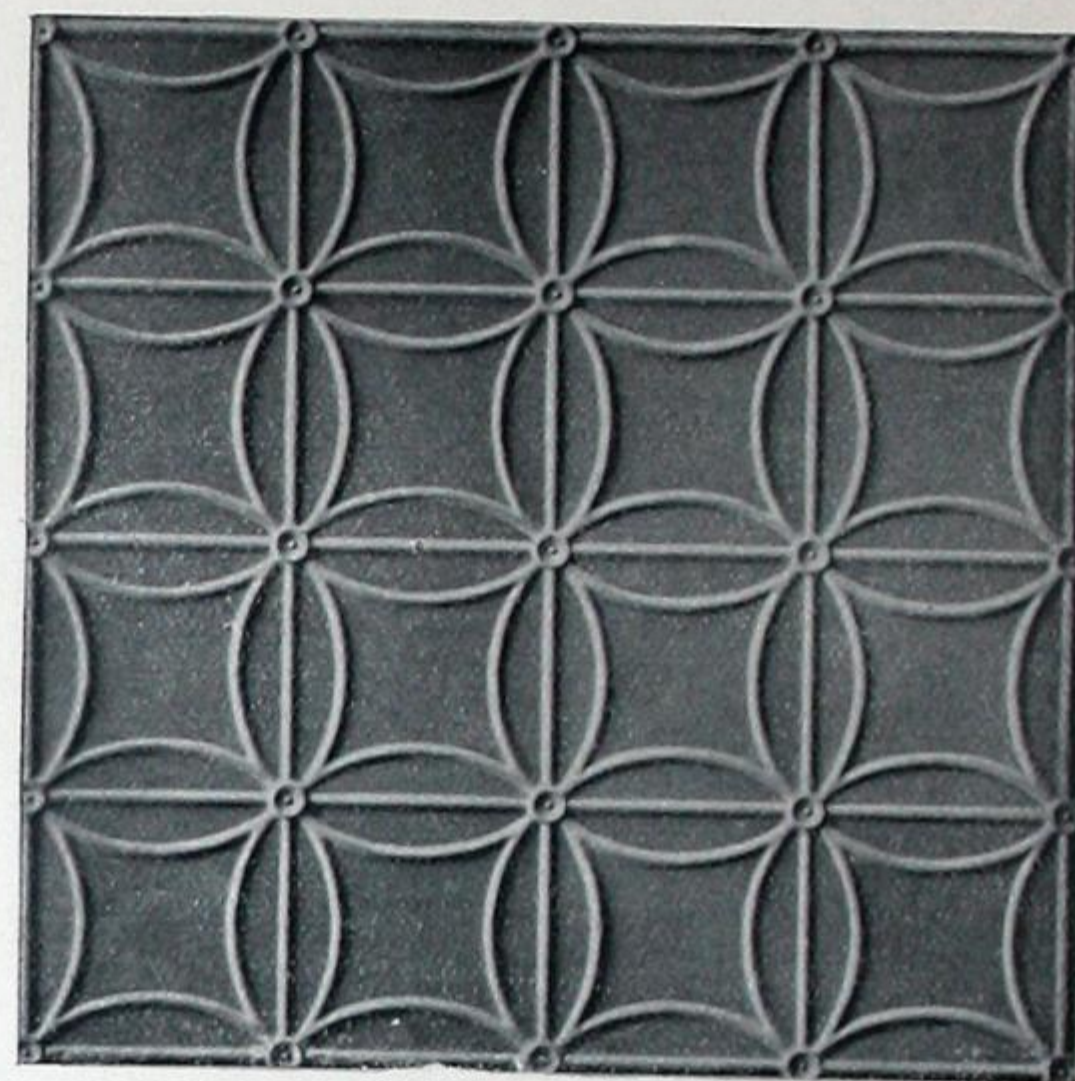

Plate No. 432.

Covering 24 x 24 inches.

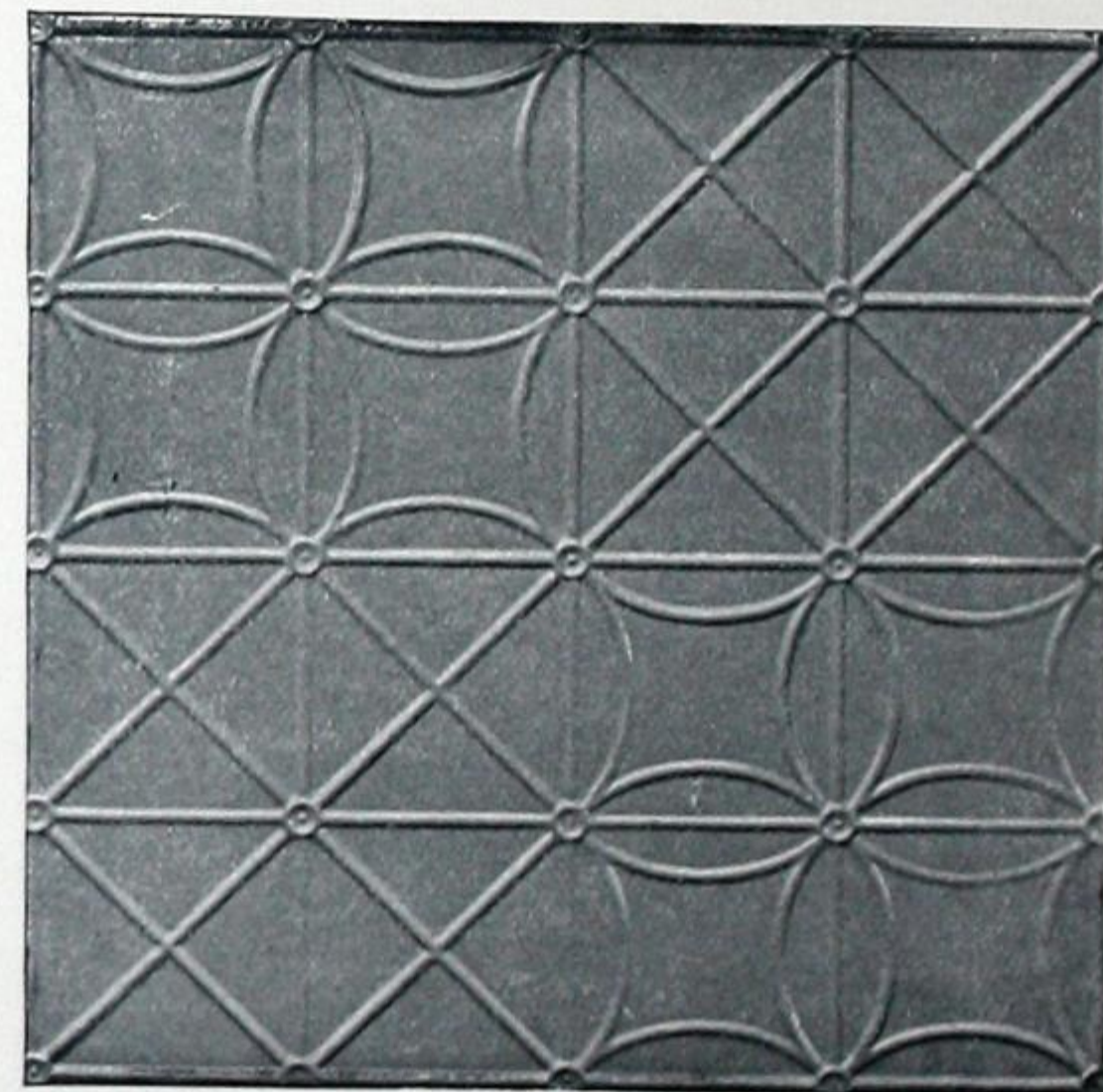

Plate No. 434.

Covering 24 x 24 inches.

Ceiling and Wall Plates.

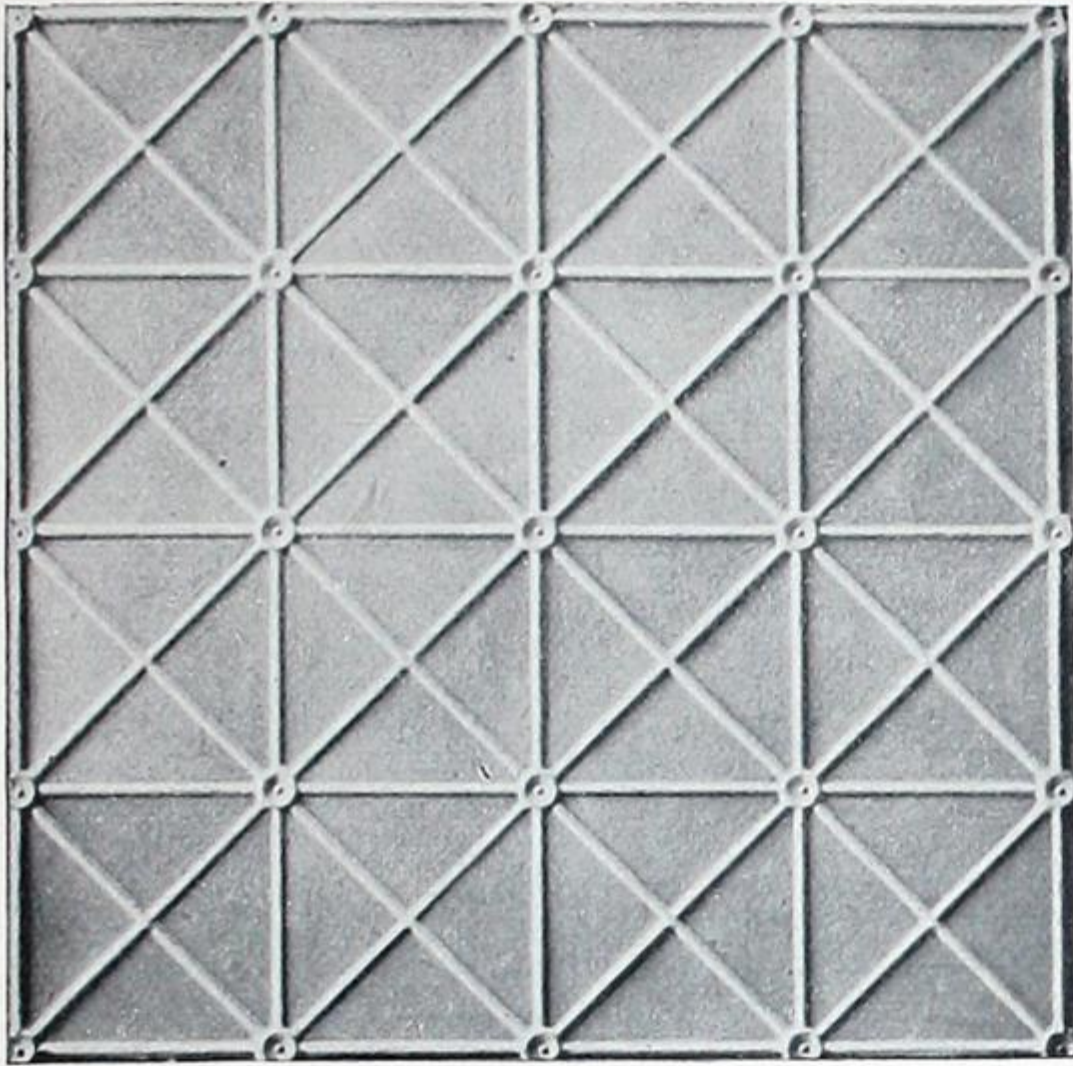
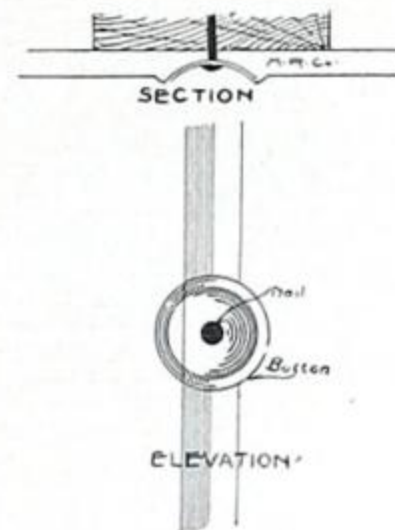

Plate No. 435.—Covering 24 x 24 inches.



Plate No. 436.—Covering 24 x 24 inches.
Size of tile, 6 inches.



Section and Elevation of Joint.

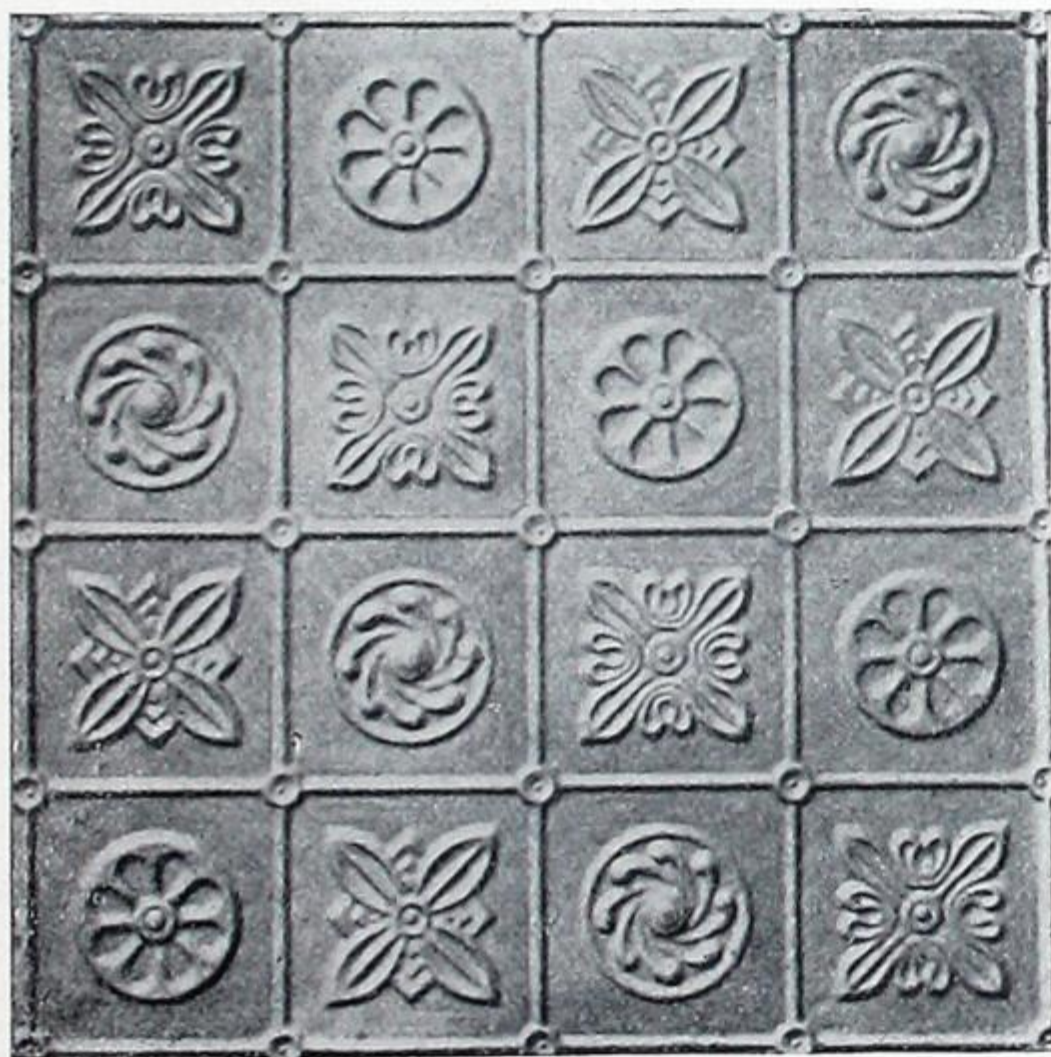

Plate No. 437.—Covering 24 x 24 inches.

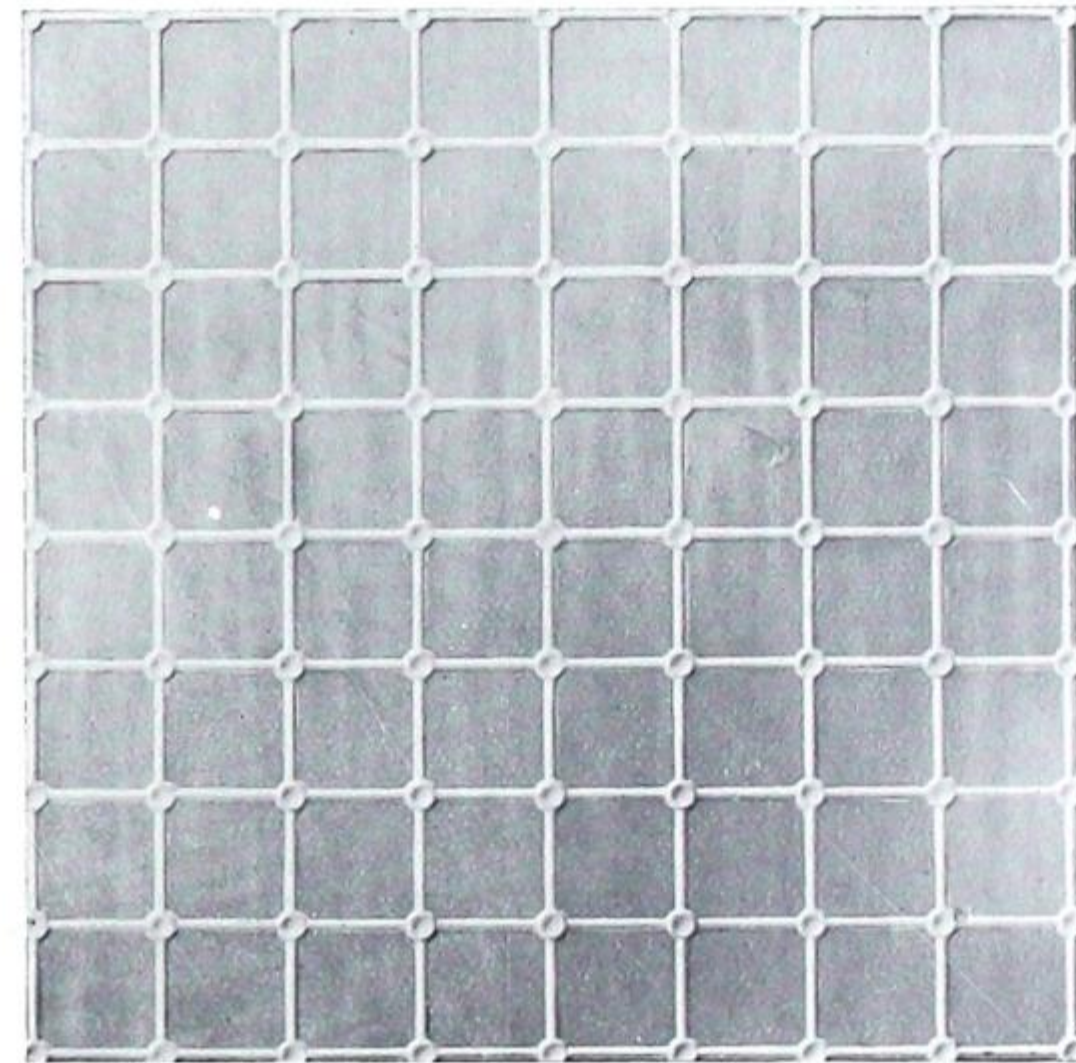

Plate No. 438 —Covering 24 x 24 inches.
Size of tile, 3 inches.

Ceiling Plates.

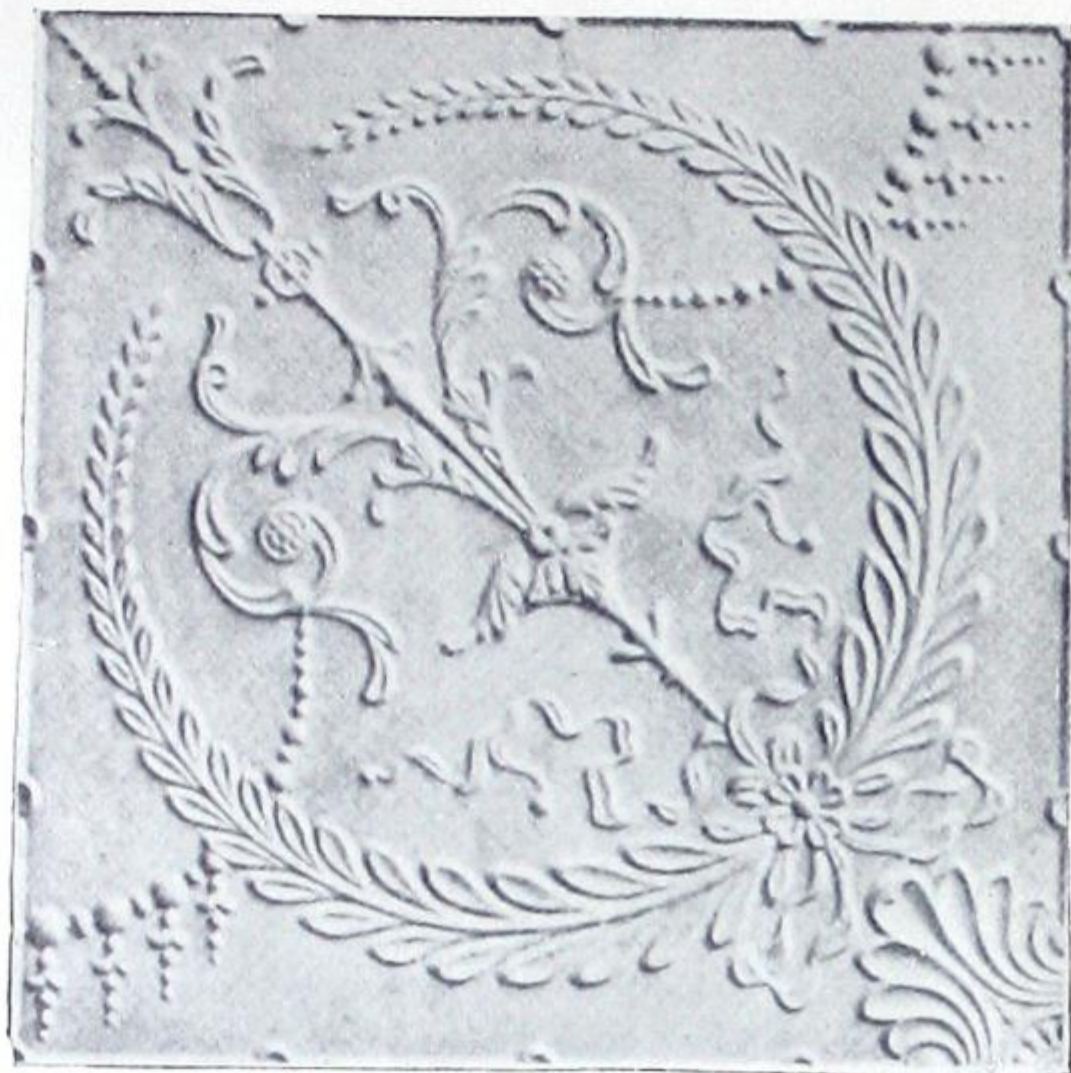

Plate No. 439.—Covering 24 x 24 inches.
Design is 48 x 48 inches when completed, see Fig. 3001.



Plate No. 440.—Covering 24 x 24 inches.
See also Fig. 3002.



Plate No. 441.—Covering 24 x 24 inches.
Design is 48 x 48 inches when completed, see Fig. 3003.

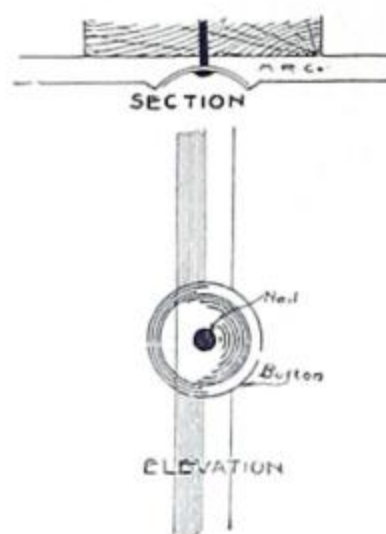

Section and Elevation of Joint.



Plate No. 442.—Covering 24 x 24 inches. Used as a combination with Plate No. 441, as shown in Fig. 3101, or as a frieze or border.

Ceiling Plates.



Plate No. 443. Covering 24 x 24 inches.
Design is 48x48 inches when completed. (See Fig. 3004.)

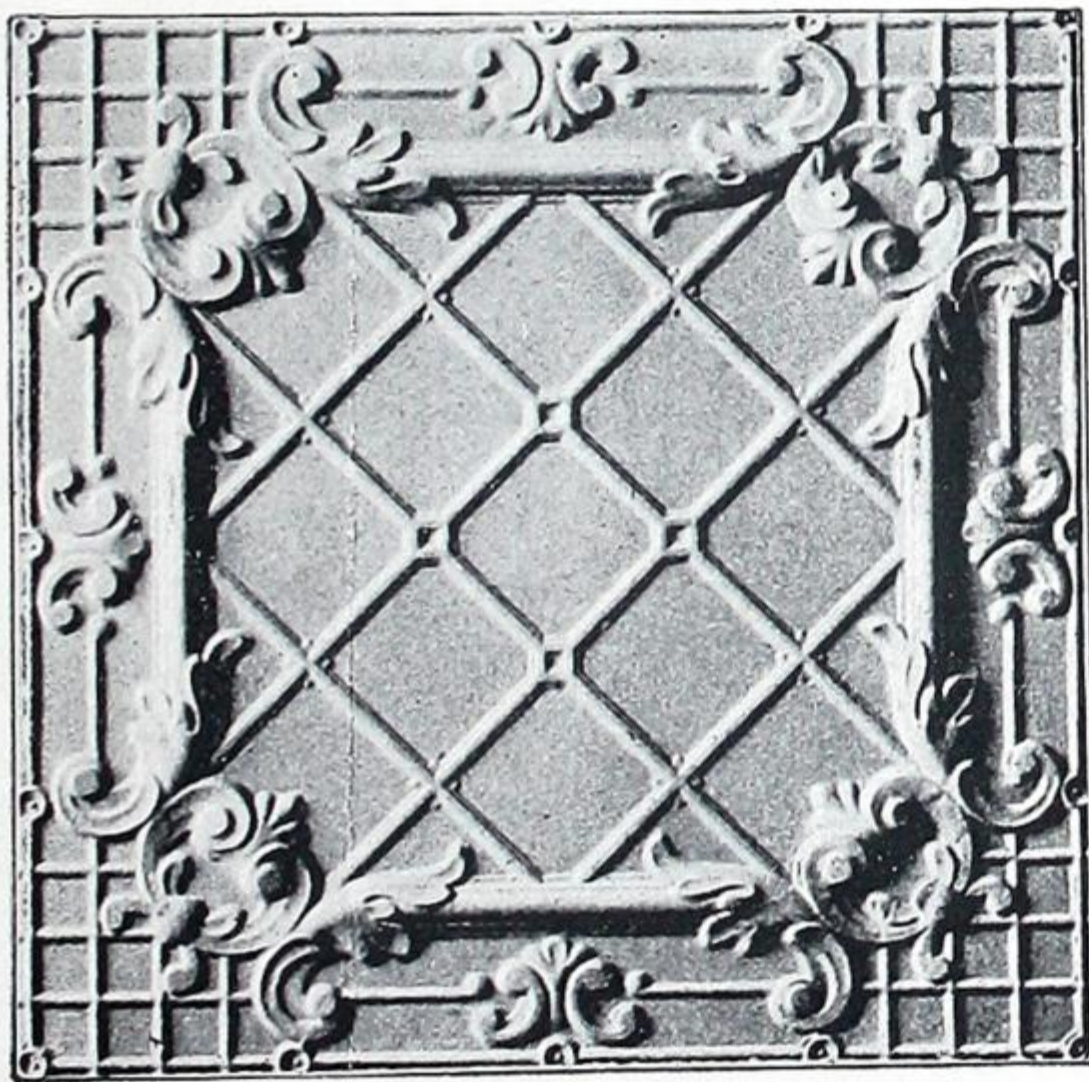

Plate No. 444. Covering 24 x 24 inches.
(See also Fig. 3005.)

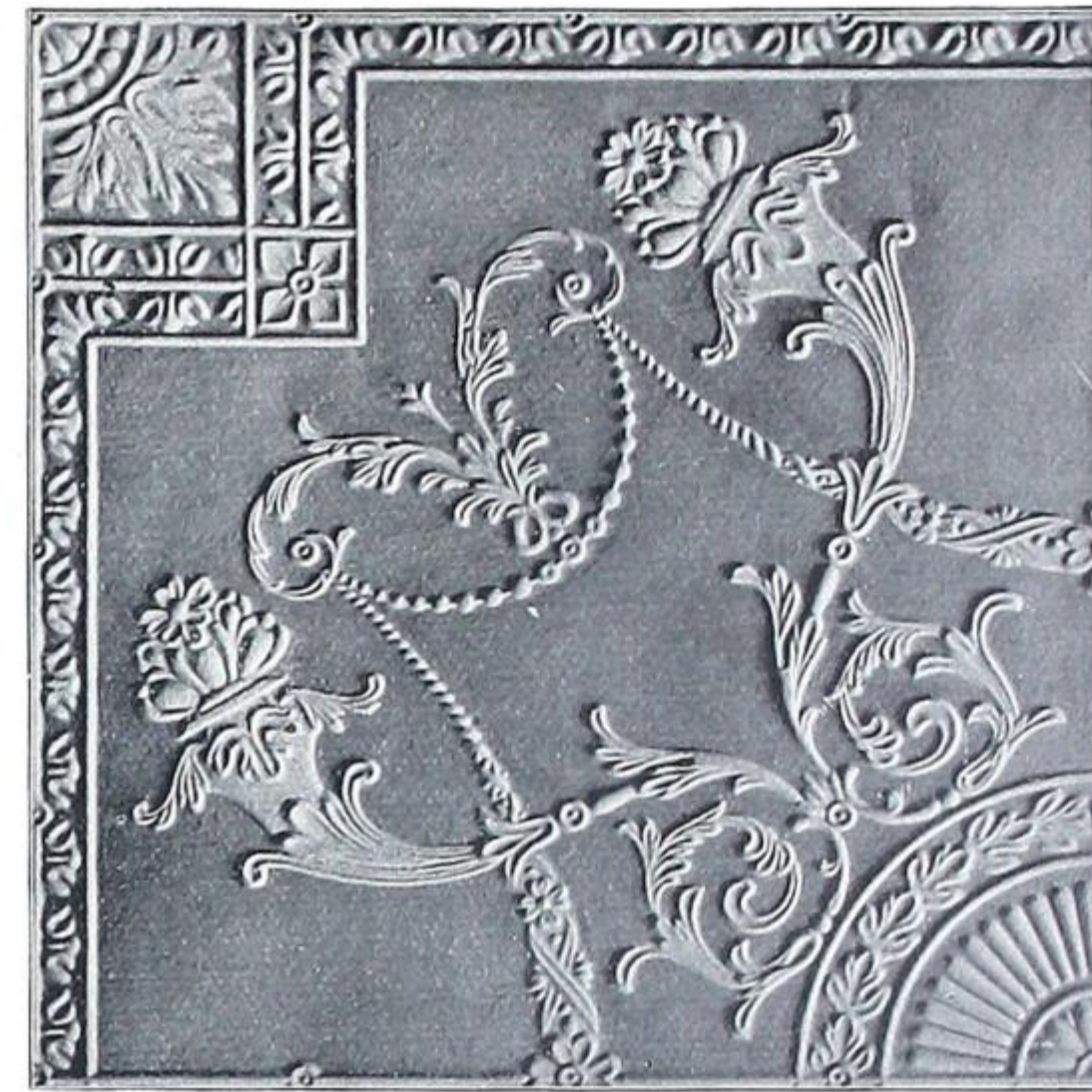
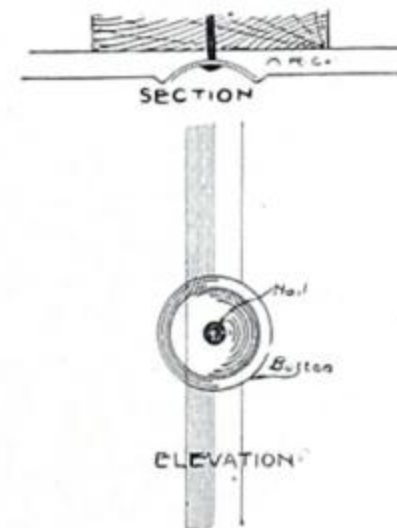

Plate No. 445. Covering 24 x 24 inches.
Design is 48x48 inches when completed. (See Fig. 3006.)



Section and Elevation of Joint.



Plate No. 446. Covering 24 x 24 inches.
Used as a combination with plate No. 445, as shown in
Fig. 3100, or as a frieze or border.

Ceiling Plates.

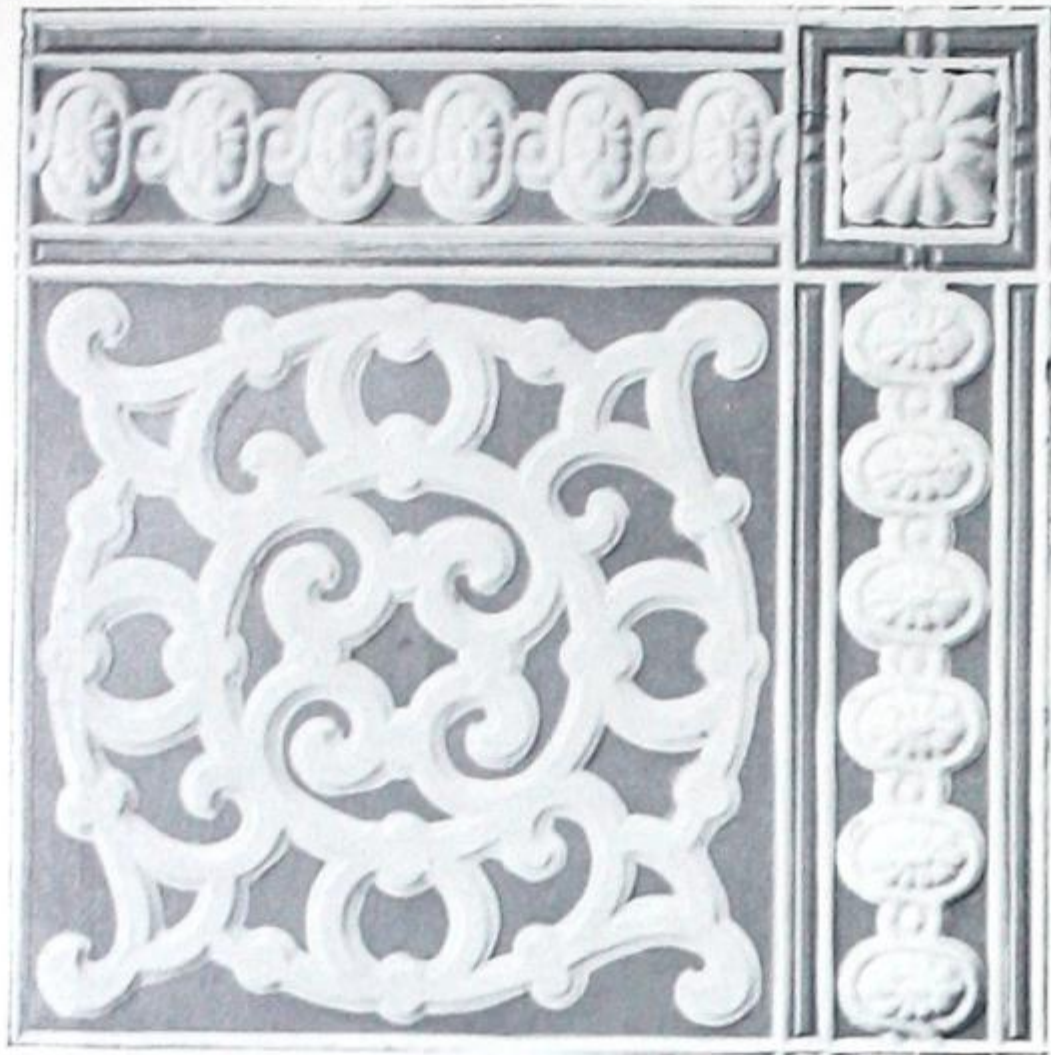

No. 476.—Covering 24 x 24 inches.
Continuation of this design is shown in Fig. 3007.



No. 478.—Covering 24 x 24 inches.

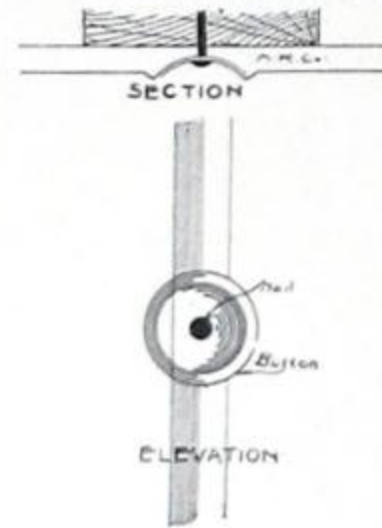

Section and Elevation of Joint on Plate No. 477.

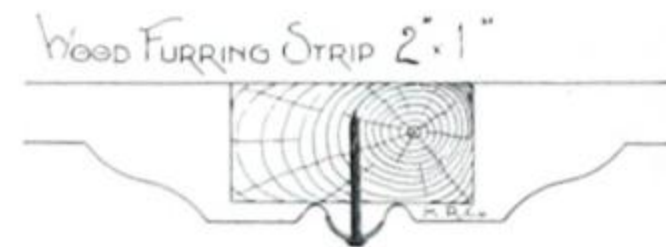

Section of Joint on Plate No. 478.

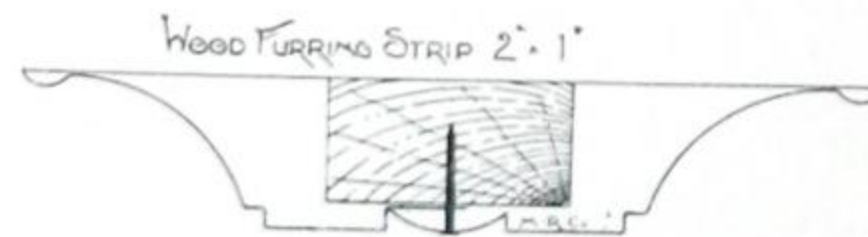

Section of Joint on Plate No. 479.

We can also supply Plates or similar design to No. 478 and 479 with any monogram. Price on receipt of specification.

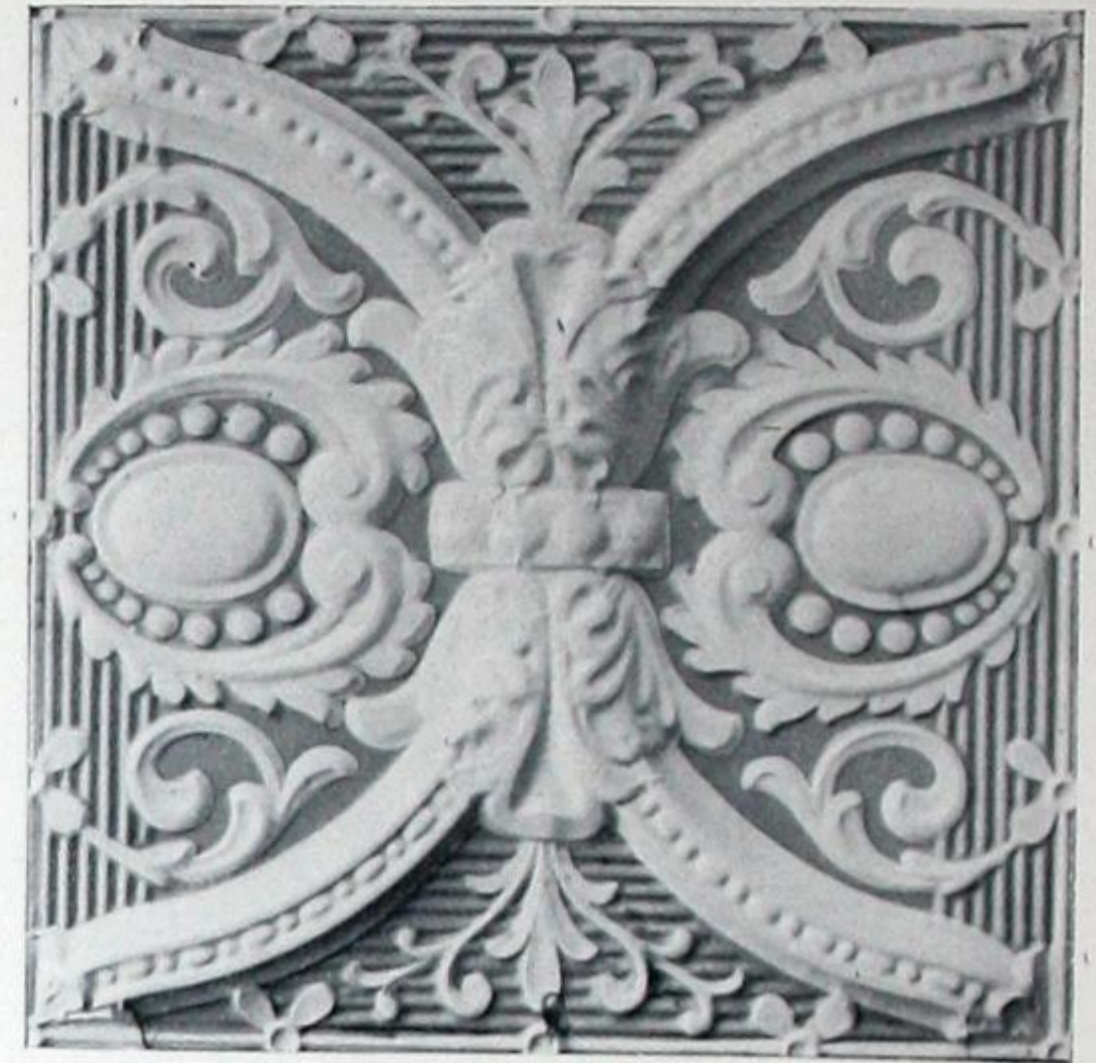

No. 477.—Covering 24 x 24 inches.
Continuation of this design is shown in Figs. 3102, 3103, and 3104.



No. 479.—Covering 24 x 24 inches.

Ceiling Plates.



Plate No. 482.—Covering 24 x 24 inches.

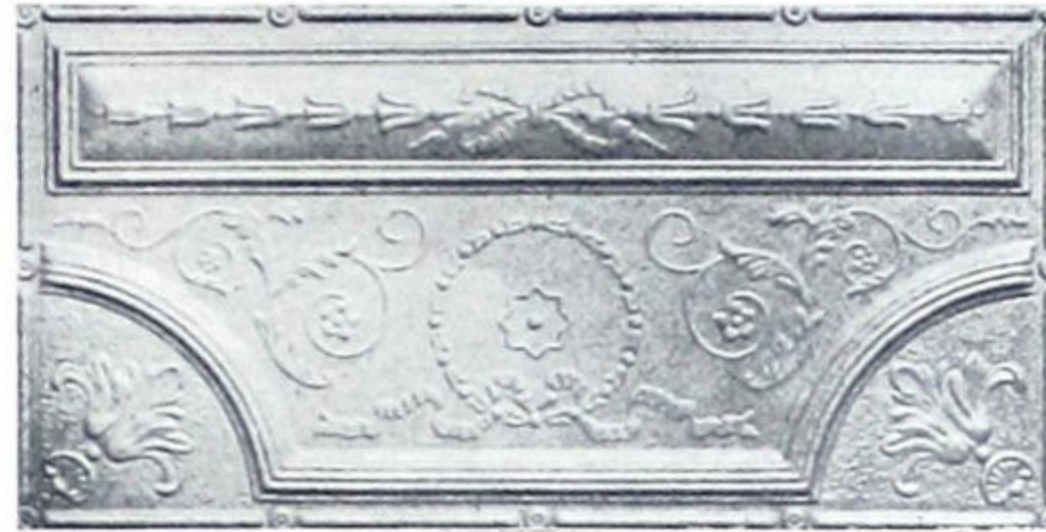

Plate No. 483.—Covering 12 x 24 inches.
Used in connection with Plate No. 482.



Plate No. 485.—Covering 24 x 24 inches.



Plate No. 486.—Covering 18 x 24 inches.
Used in connection with Plate No. 485.

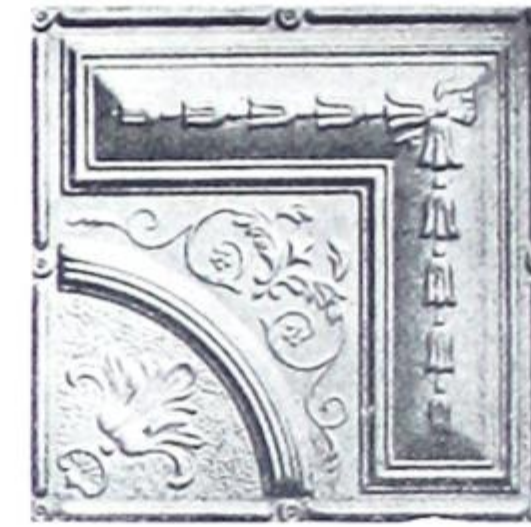

Plate No. 484.—(Inner Mitre.)

Covering 12 x 12 inches. Used in connection with Plate No. 482. Can also furnish outer mitres, size 24 x 24 inches.



Plate No. 487.—(Inner Mitre.)

Covering 18 x 18 inches. Used in connection with Plate No. 485. Can also furnish outer mitres, size 24 x 24 inches.

GRIFFIN.



Plate No. 454.—Covering 12x12 inches.

GRIFFIN.



Plate No. 455.—Covering 12x12 inches.

Dado Plates.

RENAISSANCE.



Plate No. 456.—Covering 9x9 ins.

DOLPHIN.



Plate No. 457.—Covering 12x24 inches

RENAISSANCE.

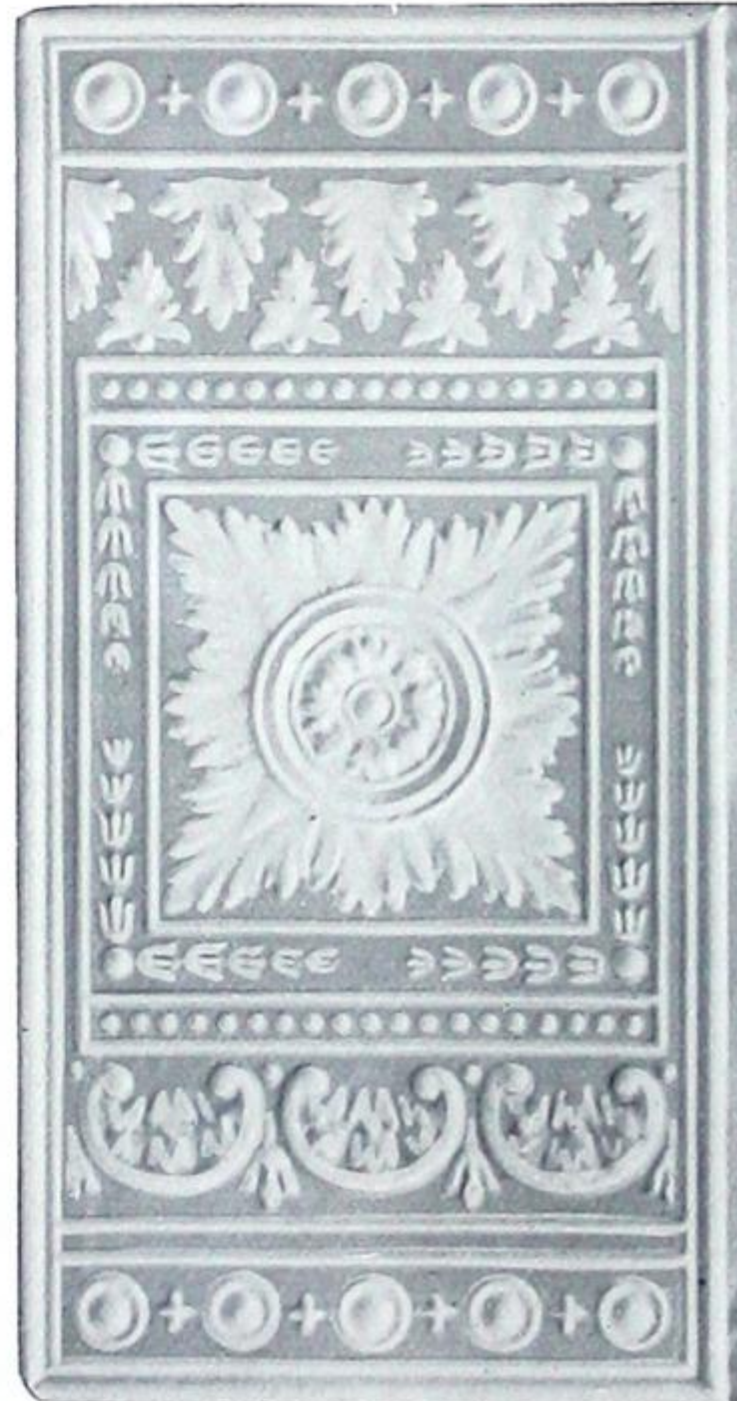

Plate No. 458.—Covering 12x24 inches.



RENAISSANCE.



Plate No. 459.—Covering 9x24 ins.

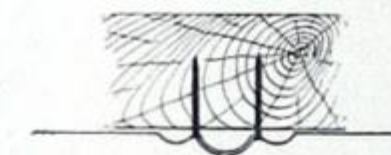

Section of Joint of Plate Nos. 454, 455, 456, 457, 458, 459.

Corrugated and Beaded Sheets.



Plate No. 480.

Shows sheet of our 1 x $\frac{1}{4}$ -inch corrugated, six or eight feet long by 26 $\frac{1}{2}$ inches extreme width and 25 $\frac{1}{2}$ inches from centre to centre of outside corrugations



Plate No. 481.

Shows sheet of Beaded Ceiling. Size of beads 1 x $\frac{1}{4}$ inches. Sheets six or eight feet long by 27 $\frac{1}{2}$ inches wide from centre to centre of outside beads.



Cross Section of Plate No. 480.



Cross Section of Plate No. 481.

Centres.

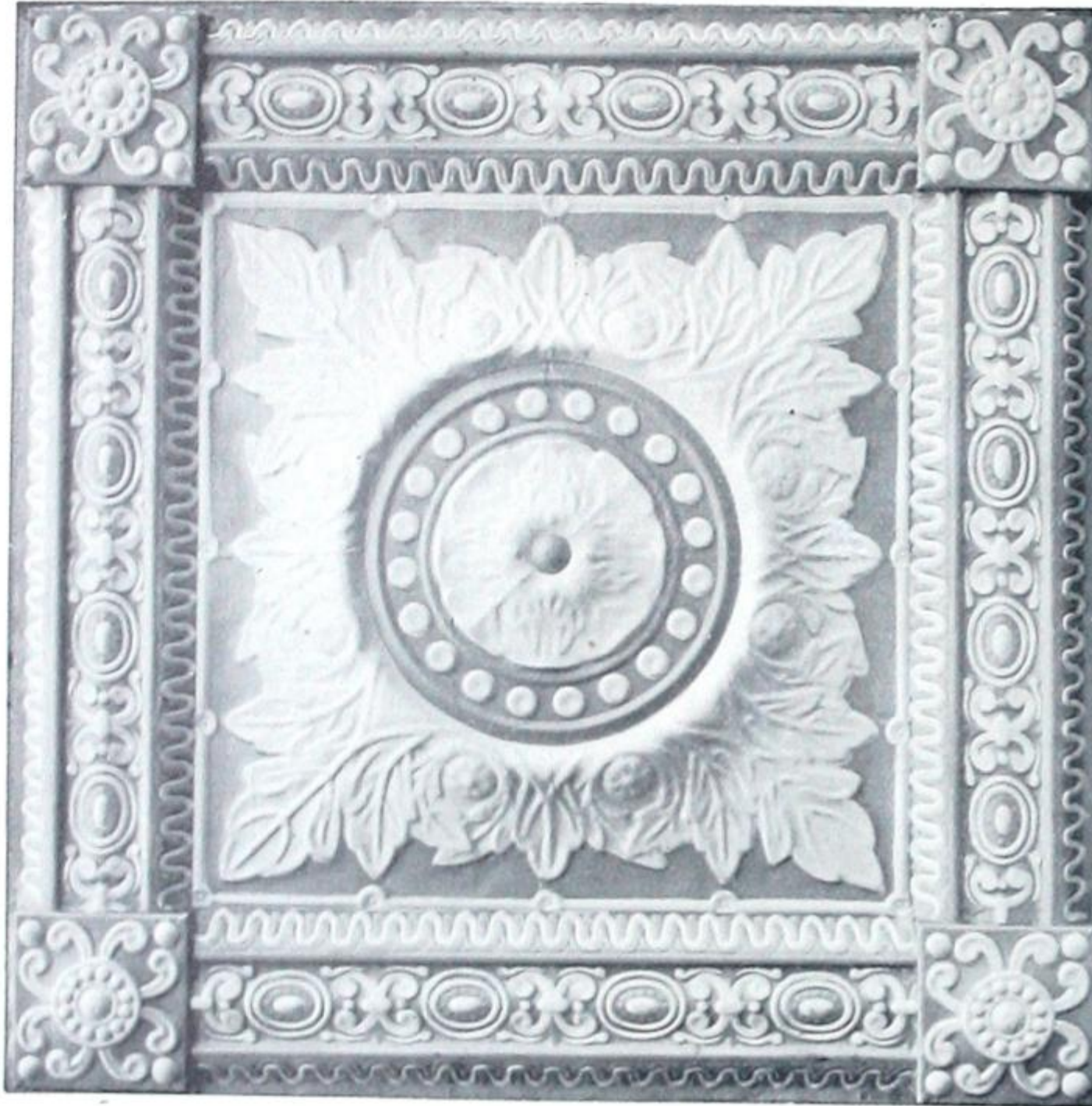

Centre Plate No. 700.

Covering 3 x 3 feet, 2 $\frac{3}{8}$ inches deep.

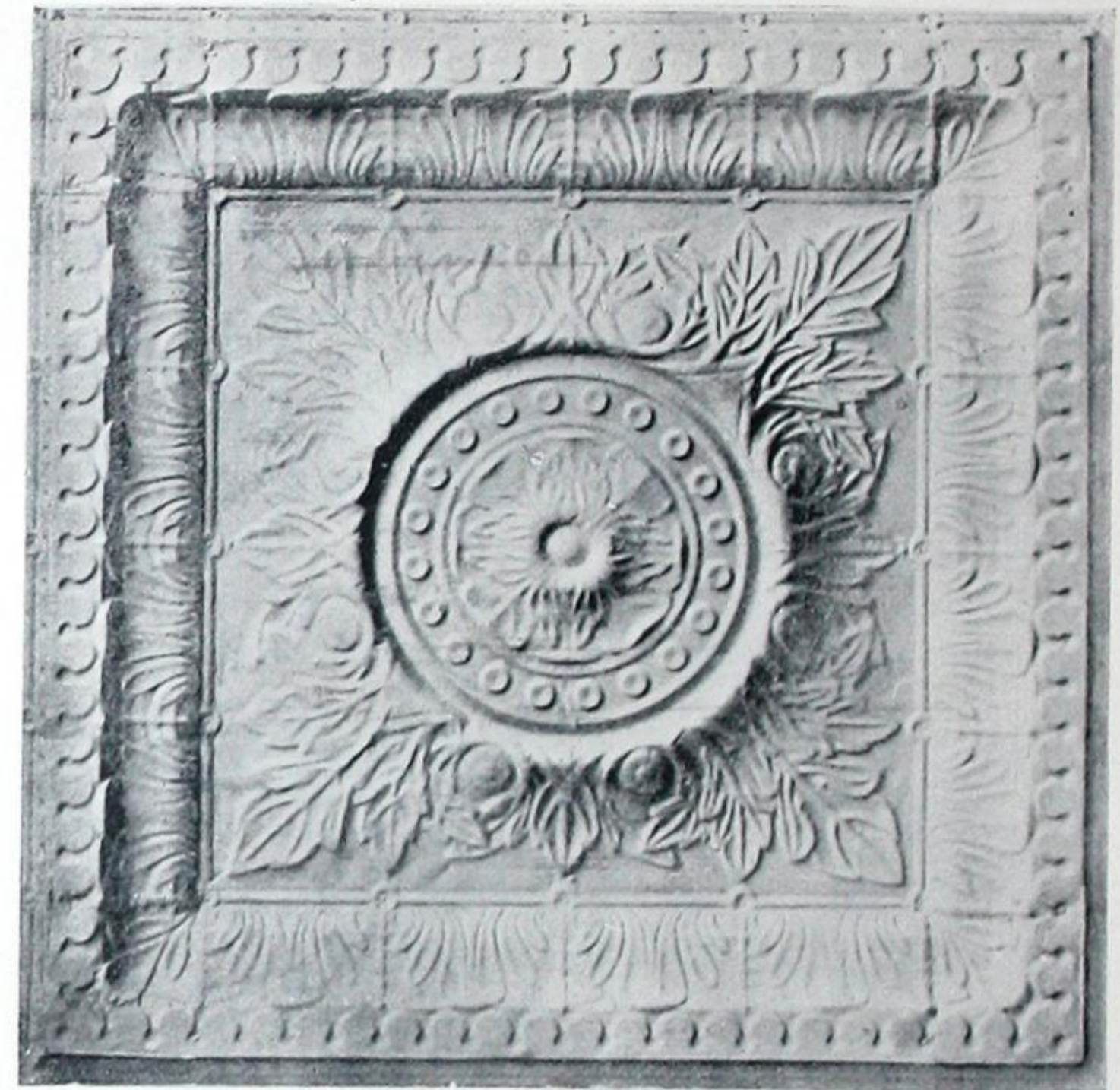

Centre Plate No. 701.

Covering 3 x 3 feet, 2 $\frac{3}{8}$ inches deep.

Entire Ceilings may be constructed of these Centres where deep panelled effect is desired, or they may be used as a Centrepiece in connection with other designs of Plates.

Centres.

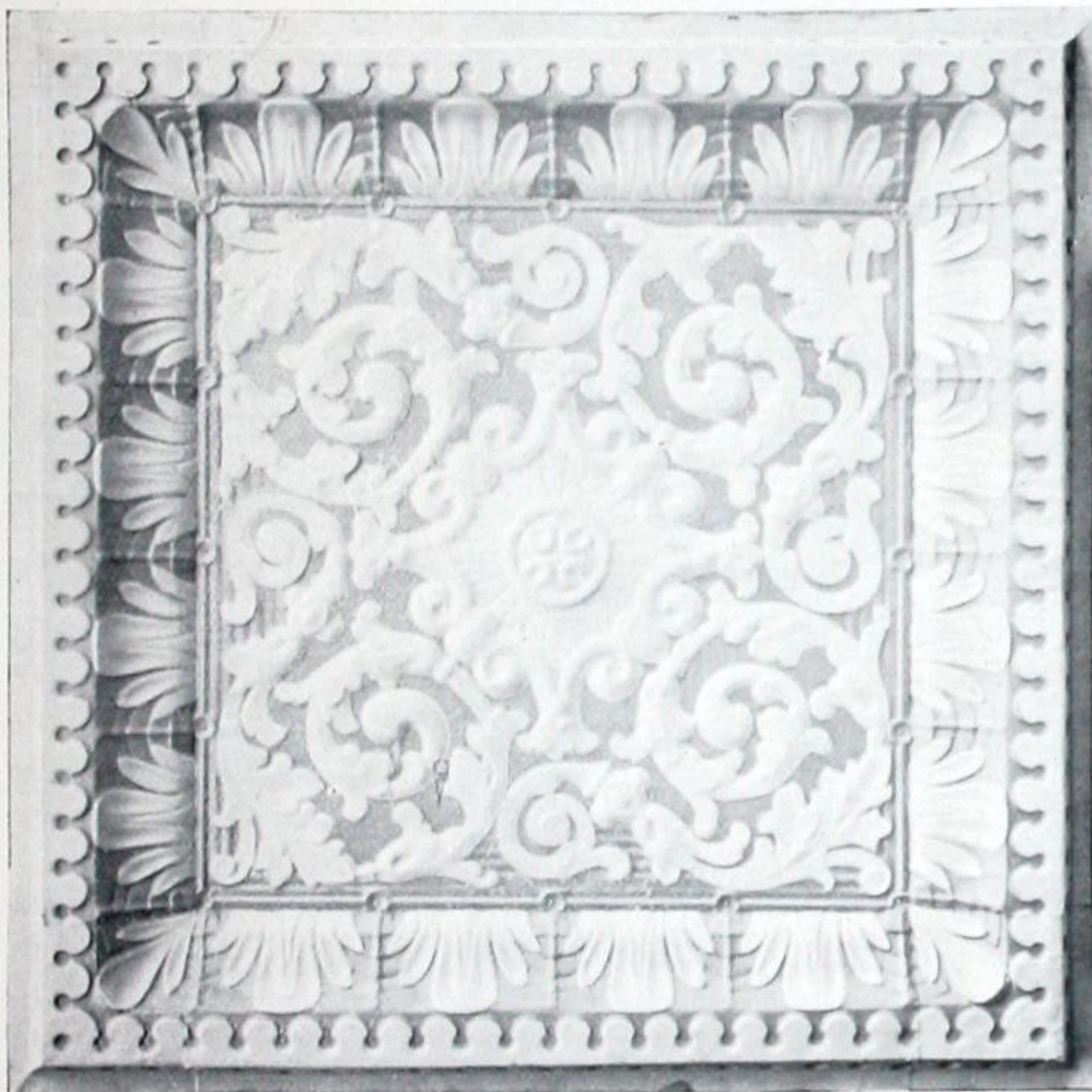

Centre Plate No. 702.

Covering 3 x 3 ft.

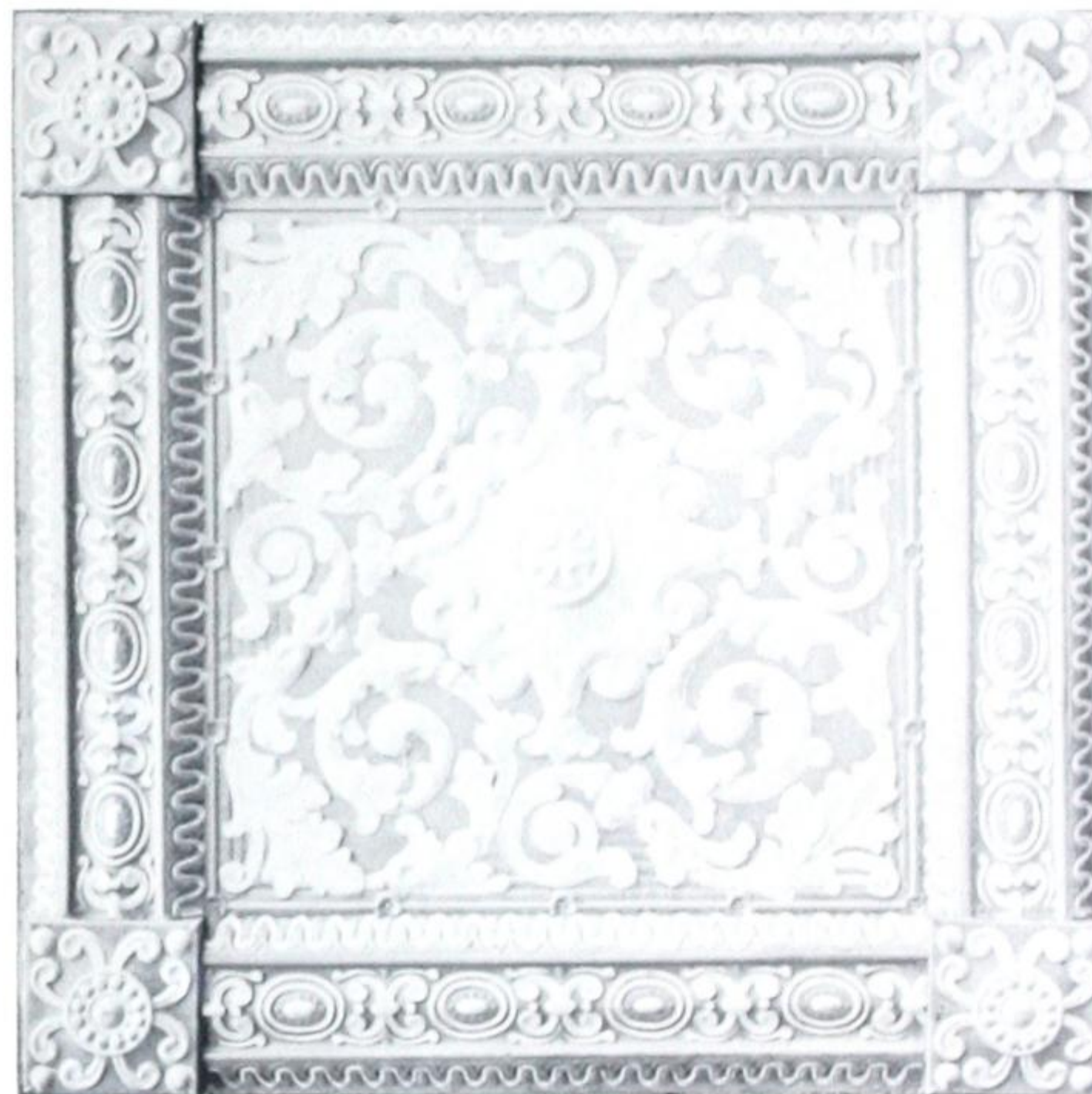

Centre Plate No. 703.

Covering 3 x 3 ft.

Entire Ceilings may be constructed of these Centres where deep panelled effect is desired, or they may be used as a Centrepiece in connection with other designs of Plates.

Centres.

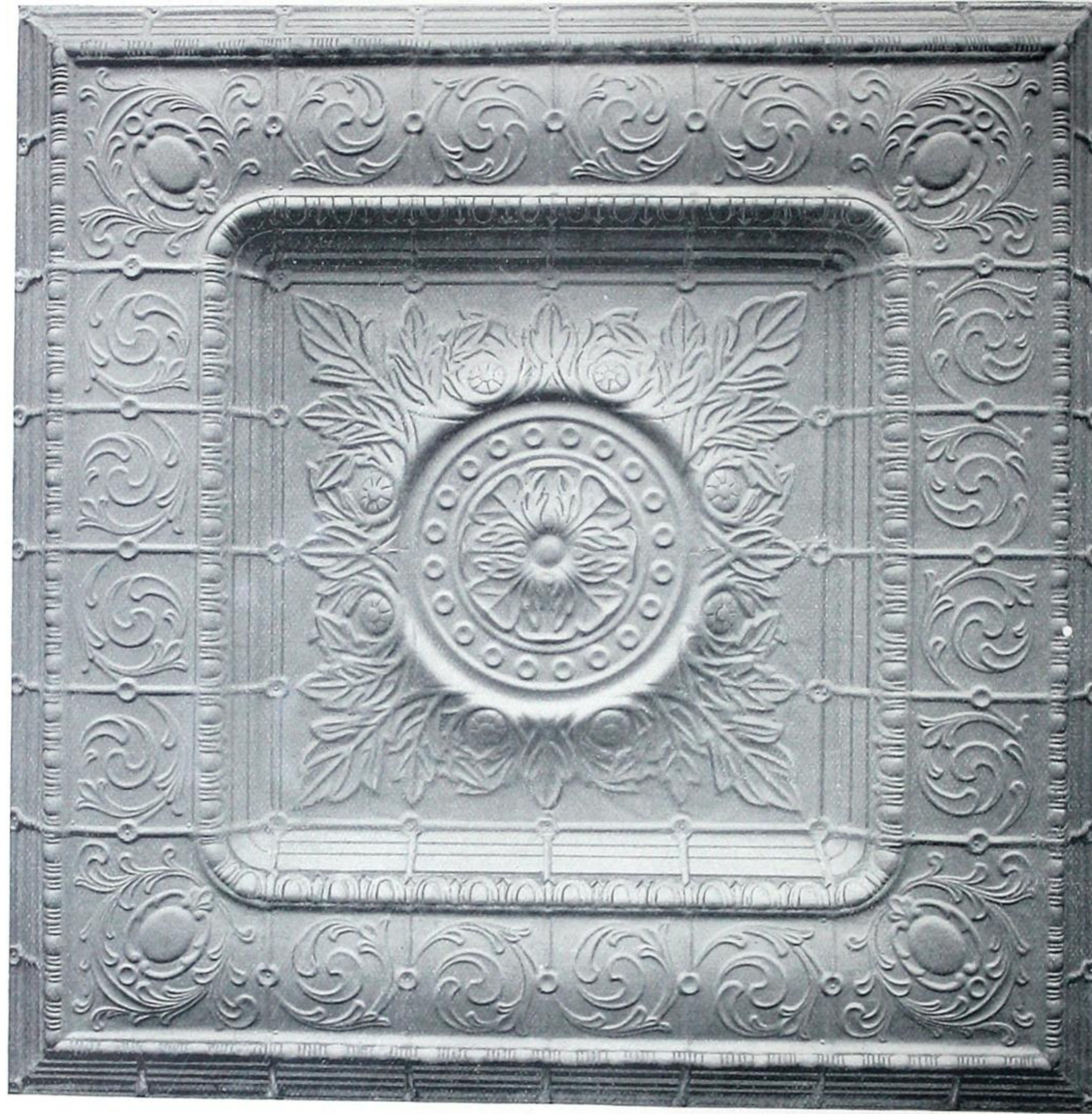

Centre Plate No. 704.—Covering 4 x 4 feet, $2\frac{3}{4}$ inches deep.

Used for entire Ceilings, where deep, massive effect is desired, or as a Centrepiece in connection with other designs of Plates.

Centres.



Centre Plate No. 705.

Covering 4 x 4 feet, 2 $\frac{3}{8}$ inches deep.

Used for entire Ceilings, where deep, massive effect is desired, or as a Centrepiece in connection with other designs of Plates.



Centres.

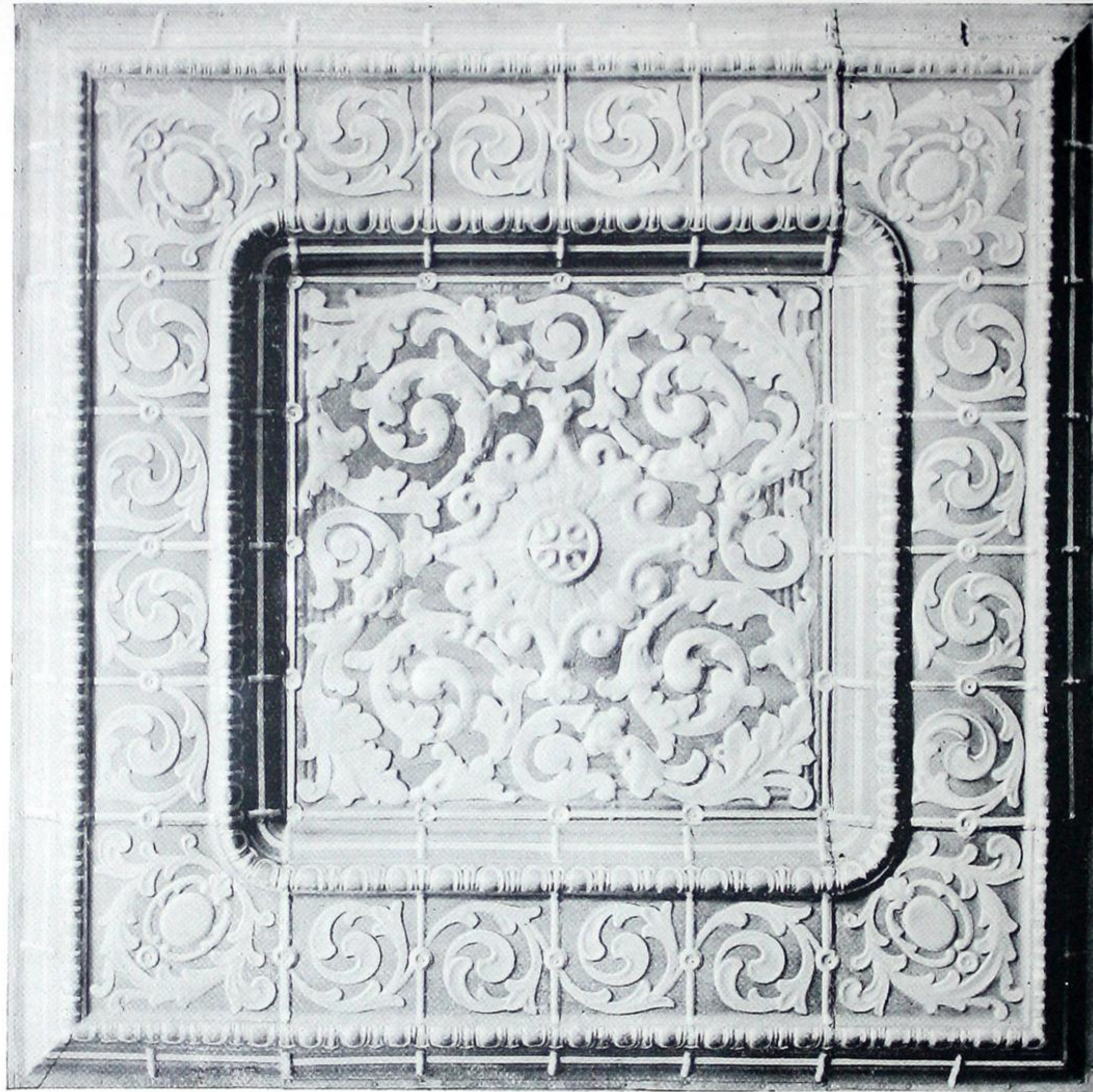

Centre Plate No. 706.—Covering 4 x 4 feet.

Used for entire Ceilings, where deep, massive effect is desired, or as a Centrepiece in connection with other designs of Plates.

Centres.

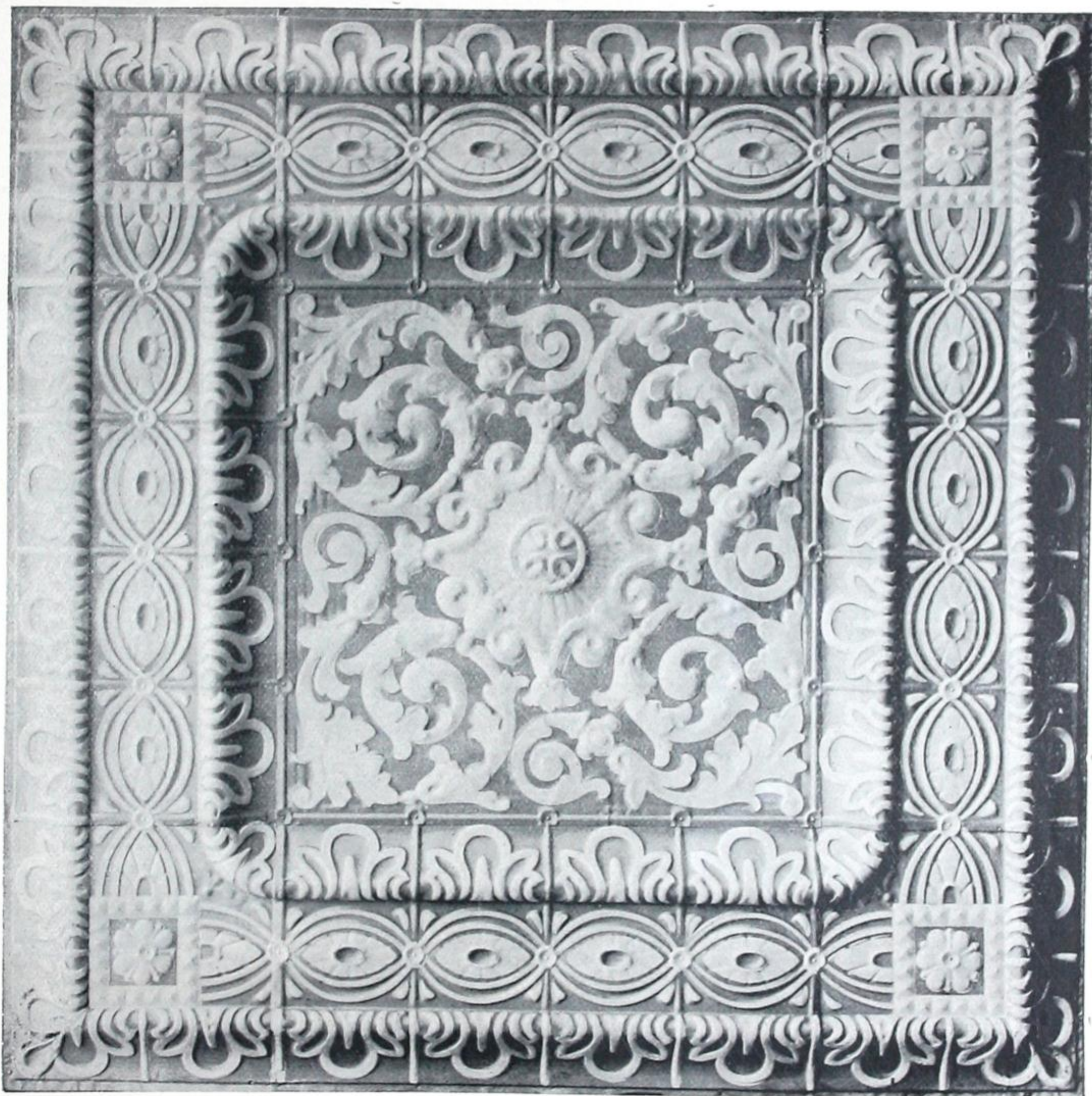

Centre Plate No. 707.—Covering 4 x 4 feet.

Used for entire Ceilings, where deep, massive effect is desired, or as a Centrepiece in connection with other designs of Plates.

Ventilating Centres.



Ventilating Centre No. 708.

58 inch diameter.



Ventilating Centre No. 709.

55 inch diameter.

Ventilating Centres.

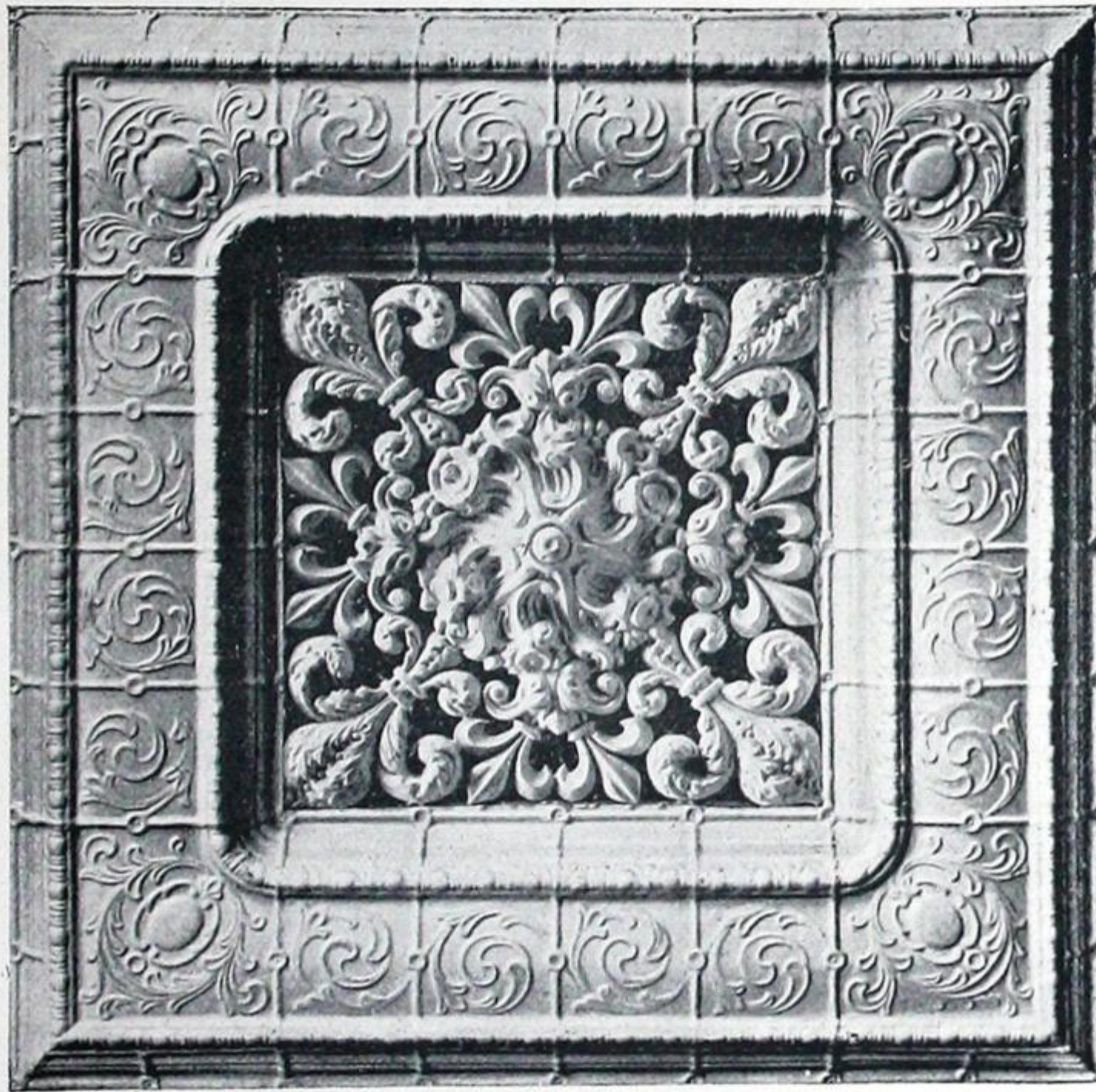

Ventilating Centre No. 710.

Size, 4 x 4 feet.



Ventilating Centre No. 719.

Size, 4 x 4 feet.

Zinc Centres.



No. 711.
17 x 26 inches.



No. 714.
12 inches in diameter.



No. 717.
28 inches in diameter.



No. 712.
8 x 8 inches.



No. 715.
13 inches in diameter.



No. 713.
7 inches in diameter.



No. 716.
8 x 8 inches.



No. 718.
21 inches in diameter.

Borders and Friezes.



No. 800.

Covering $13\frac{1}{2} \times 19\frac{1}{2}$ inches.

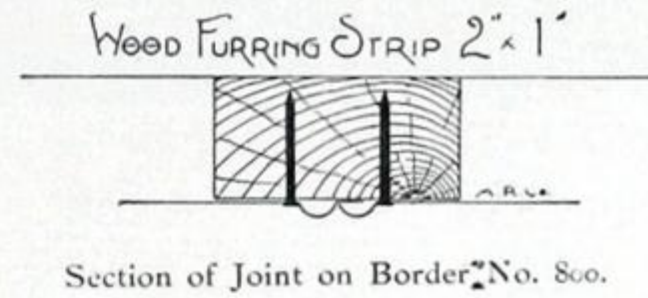

Section of Joint on Border No. 800.

"GREEK FRET" DESIGN.



No. 802.—15 inches wide, in lengths of 8 feet.

If one outer ornament is omitted, width is 12 inches.
If both outer ornaments are " " 10 "

"EMPIRE" DESIGN.



No. 804.—24 inches wide by 8 feet long. Also made with one or both outer ornaments omitted, 24, 21 or 18 ins. wide.

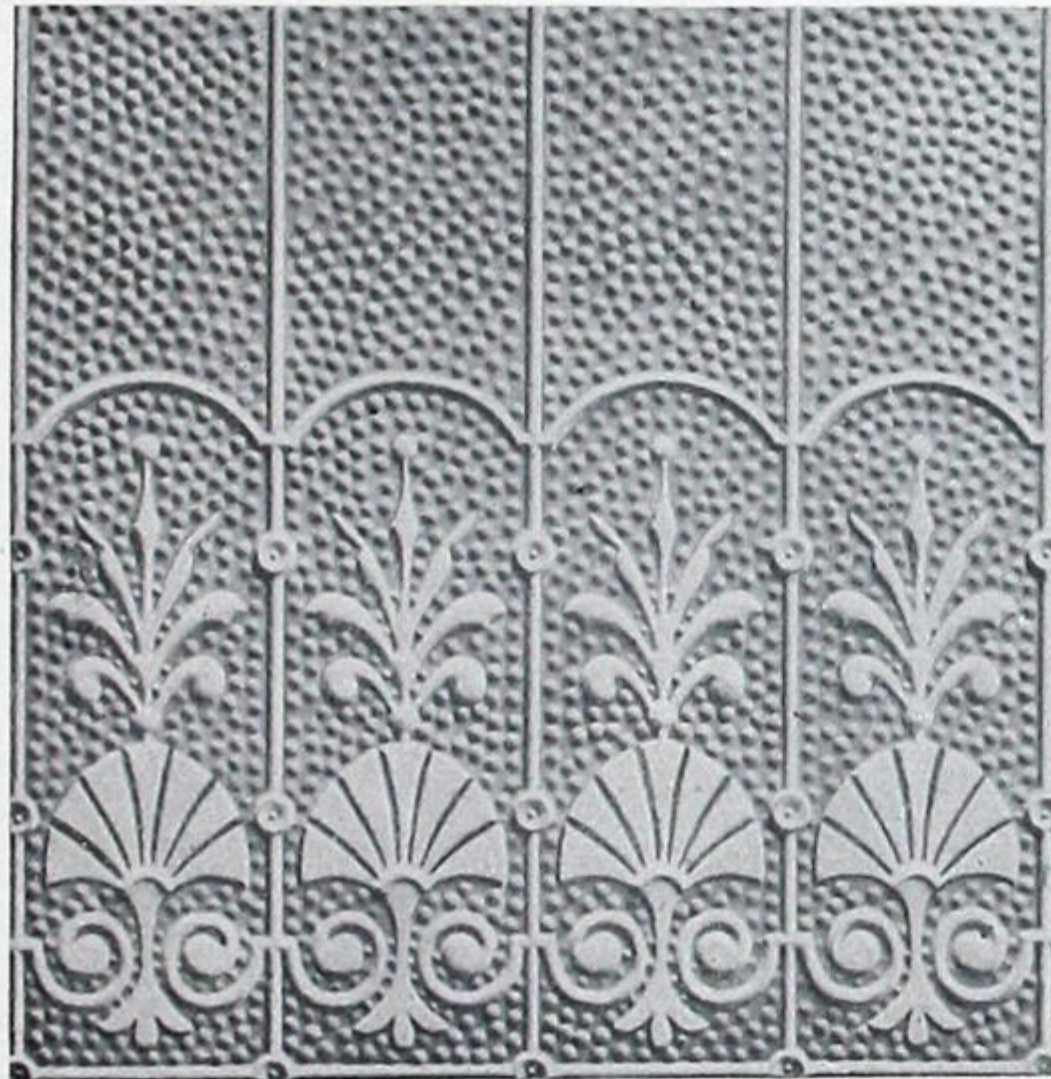

Border No. 801.—Covering 24 x 24 inches.

Can be supplied any width from 17 to 24 inches by omitting top part of plate above the ornament.

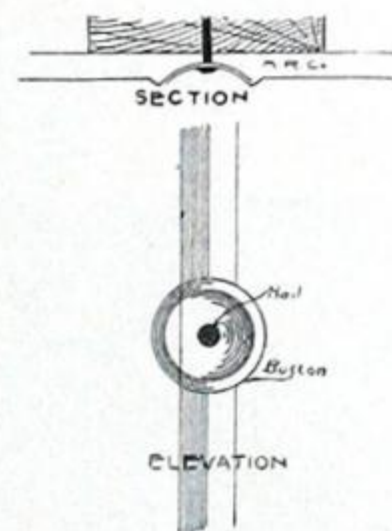

Section and Elevation of Joint on Plate No. 801.

Borders and Friezes.



FRIEZE AND FOOT MOULDING.

No. 805.—9 inches wide and 2 feet long.



GAME FRIEZE.

No. 807.—Covering 11 x 23 inches.

No. 808.—Covering 11 x 23 inches.



COMBINED CORNICE AND FRIEZE.

No 809.—Cornice: 4-inch projection by 5 inches deep, with 9-inch frieze. Also made with 6 to 12-inch filling on ceiling.

Borders and Friezes.



No. 806.—Covering 24 x 24 inches
Continuation of this design shown on page 171.

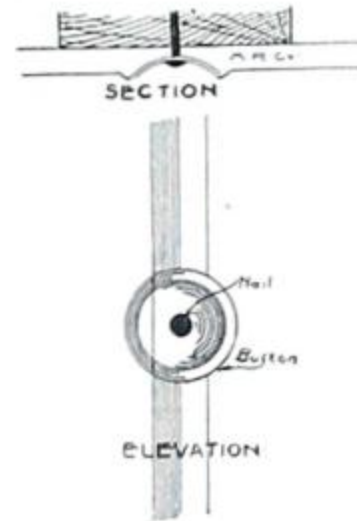

Section and Elevation of Joint
on Plates Nos. 806 and 815.



No. 815.—Covering 24 x 24 inches.
Can be supplied any width from 17 to 24 inches by omitting
top part of plate above the ornament.

Design Rd. 1899.

“FESTOON” DESIGN.



No. 810.
18 or 20 inches wide by 8 feet long.



No. 811.—15 inches wide, in lengths of 8 feet.
Also supplied 12 inches wide by omitting one outer ornament,
or, with both outer ornaments omitted, 10 inches wide.

Design Rd. 1899.

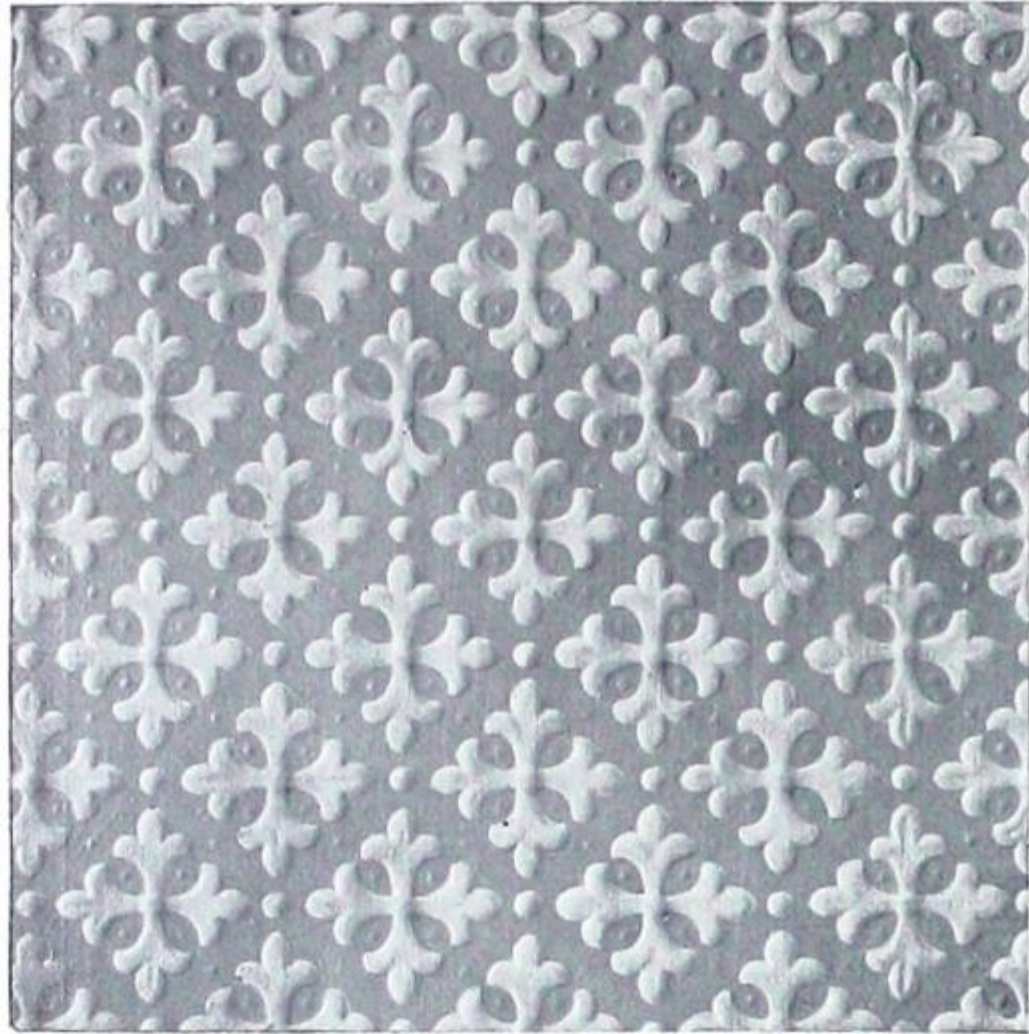

Diaper No. 812.—Sheets covering $23\frac{1}{4}$ x 93 inches.
Used for complete ceilings, or as a border.

Diapers, Borders and Fillers.

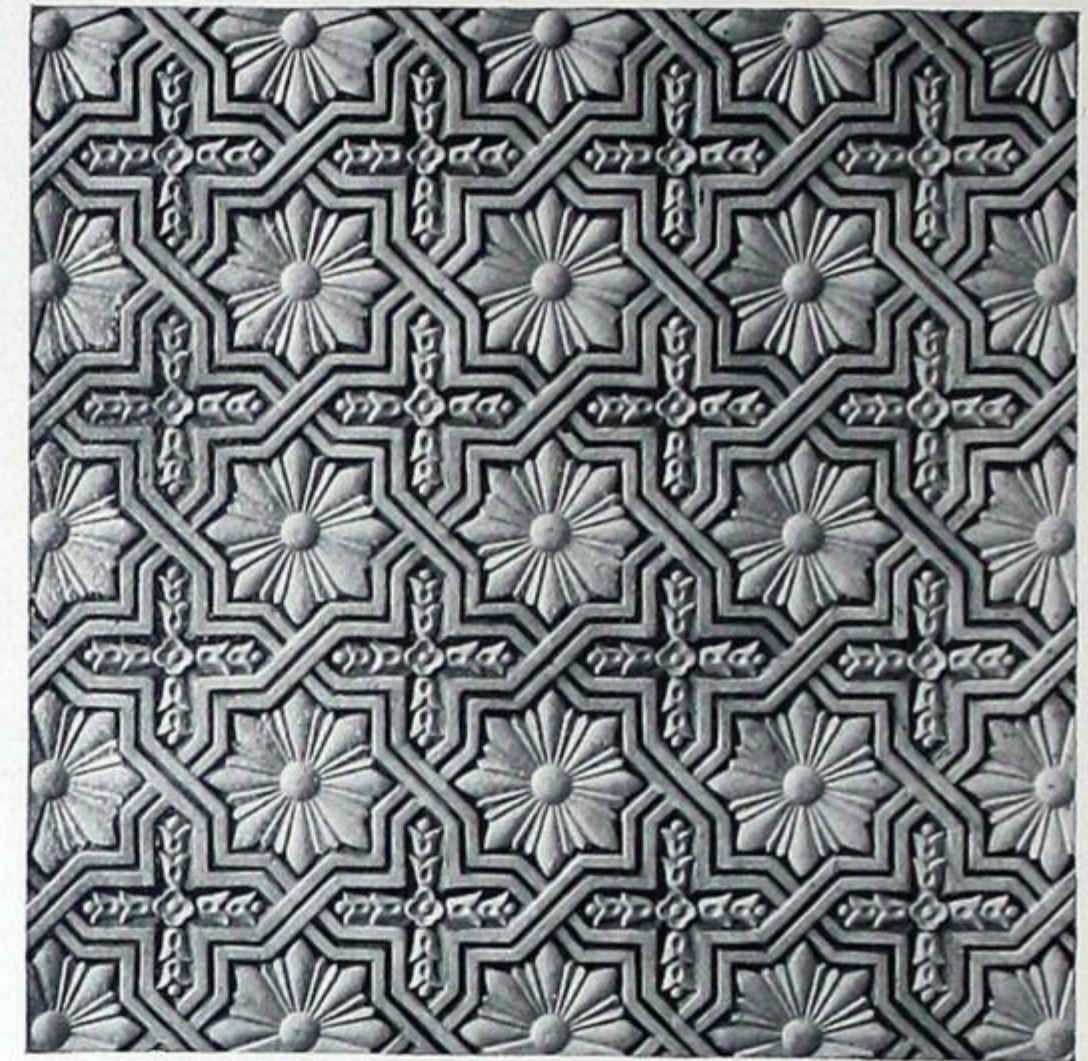

No. 814.—Covering $23\frac{1}{4}$ x 93 inches.
Used for complete ceilings, or as a border.

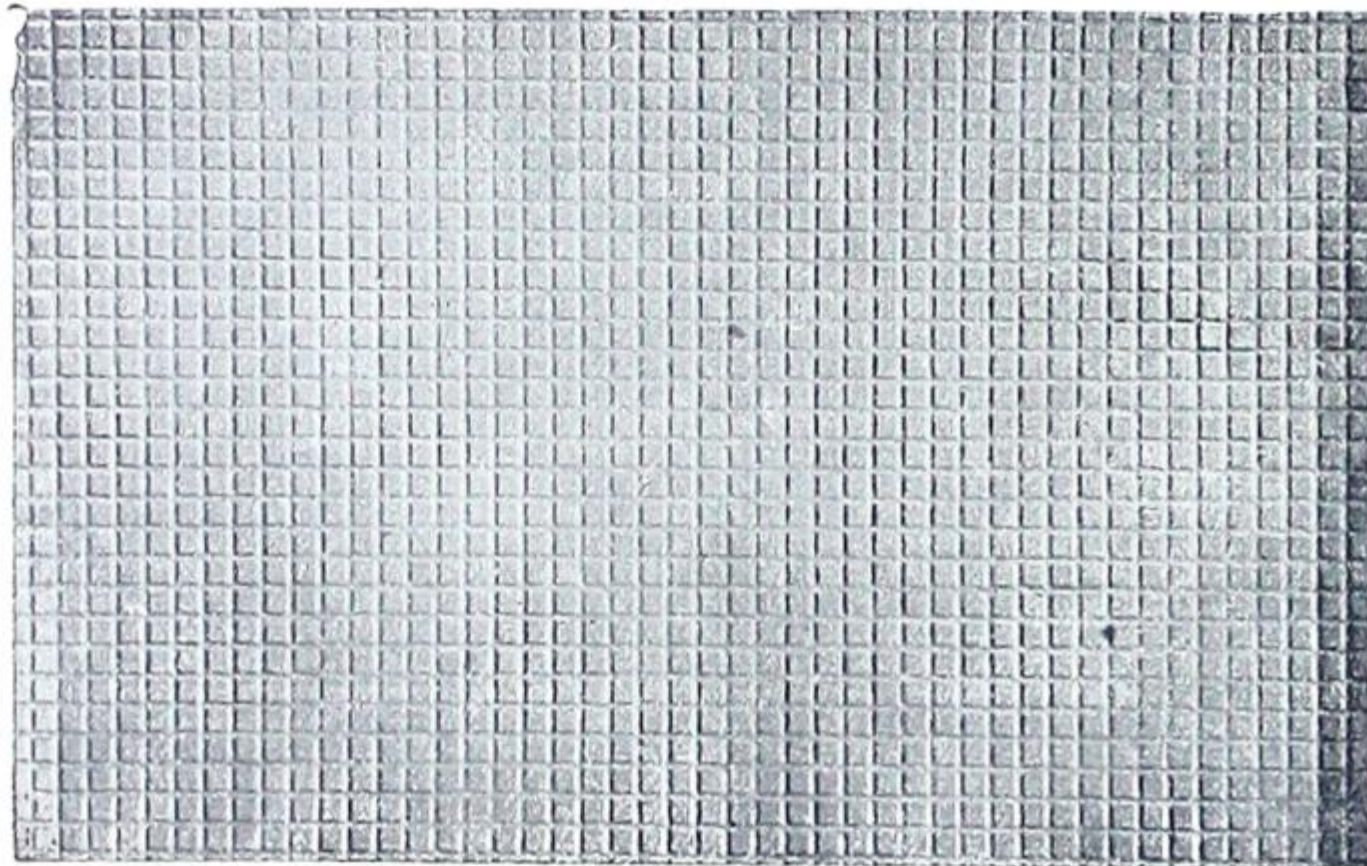

No. 813.—Used as a border, filler, or in wainscoting work.
Sheets 10 to 30 inches wide, by 4, 6 or 8 feet long.

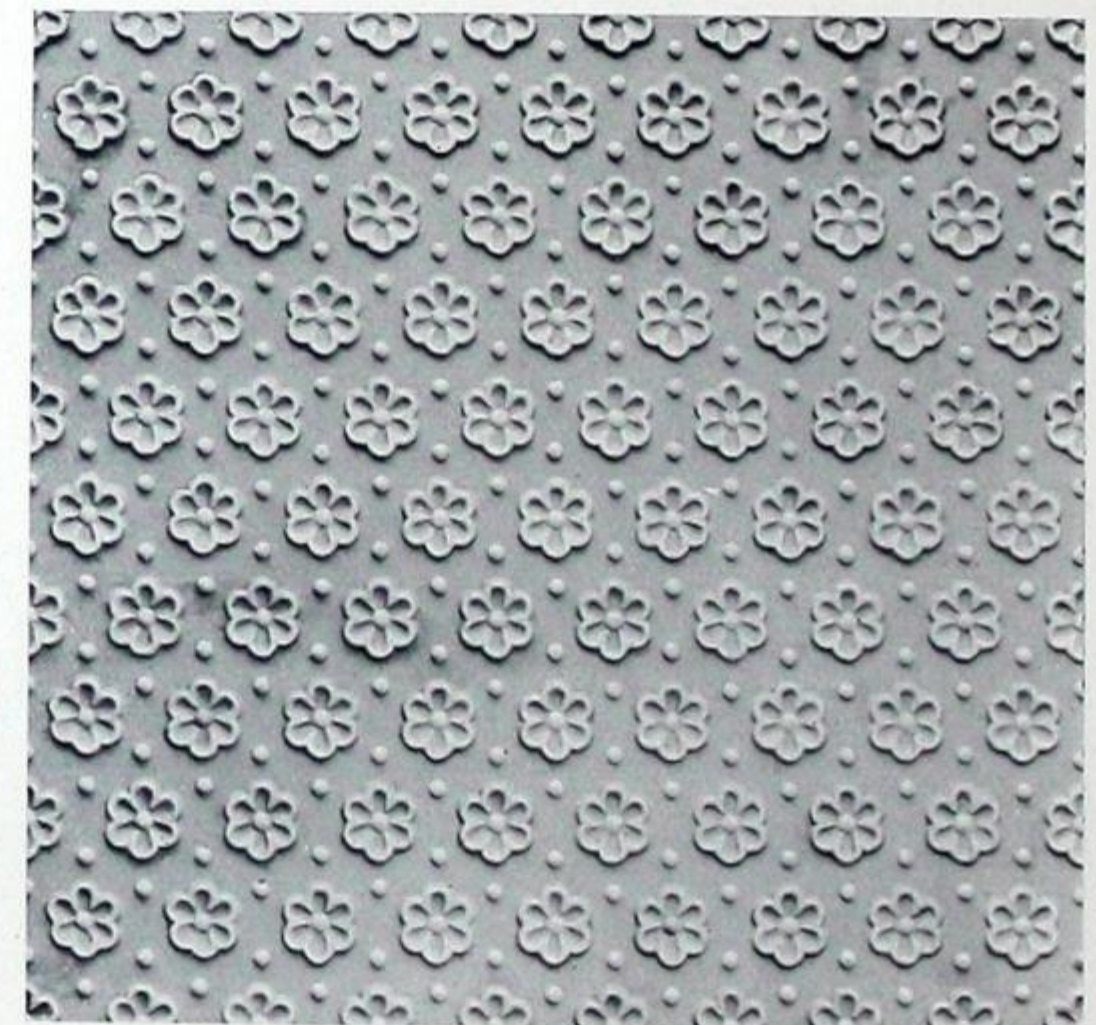

No. 816.—Covering 28 x 93 inches.
Used for complete ceilings, or as a border.

Friezes and Borders.

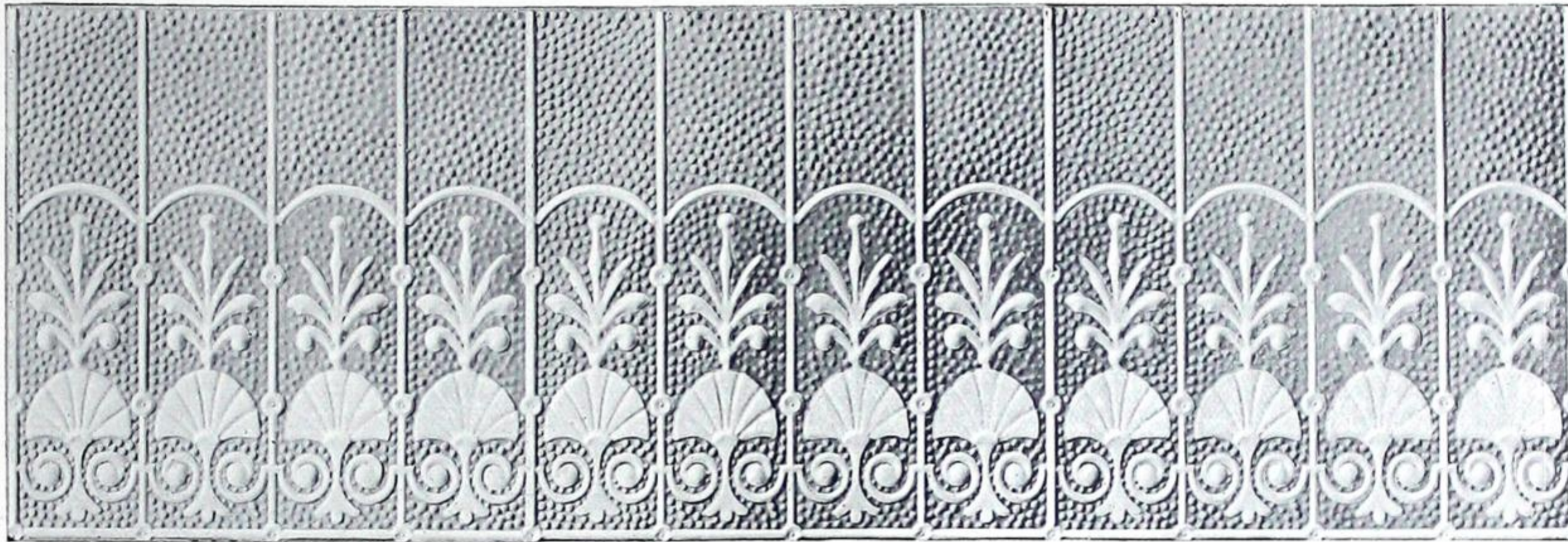

Frieze or Border No. 801.
2 x 6-foot Section.



Frieze or Border No. 806.
2 x 6-foot Section.

Friezes and Borders.



Frieze or Border No. 442.
2 x 6-foot Section.

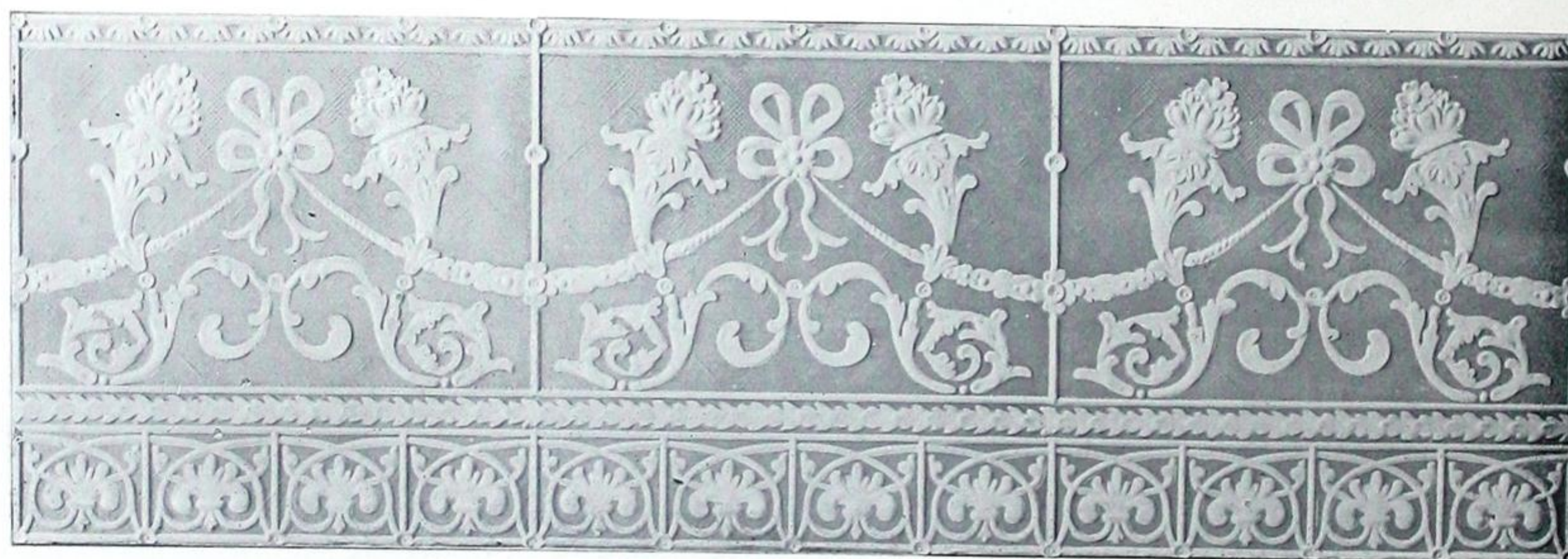

Frieze or Border No. 446.
2 x 6-foot Section.

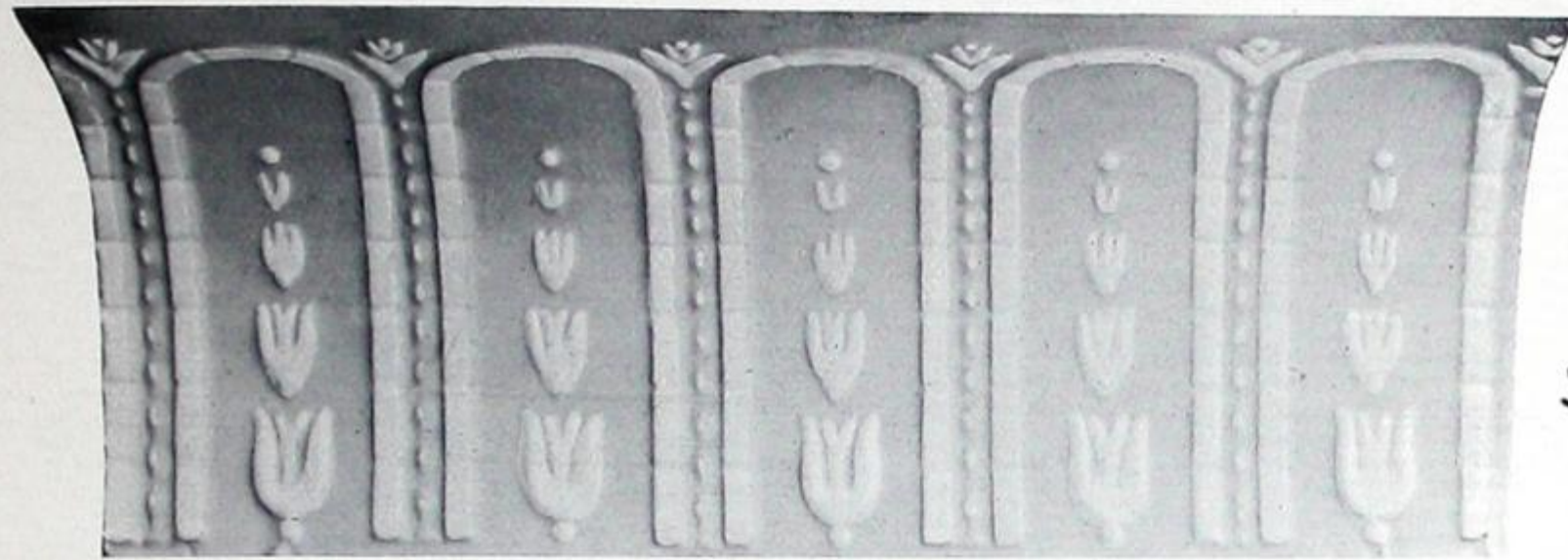

Cove Cornice No. 300.
12 and 15-inch girth.

Cornices.

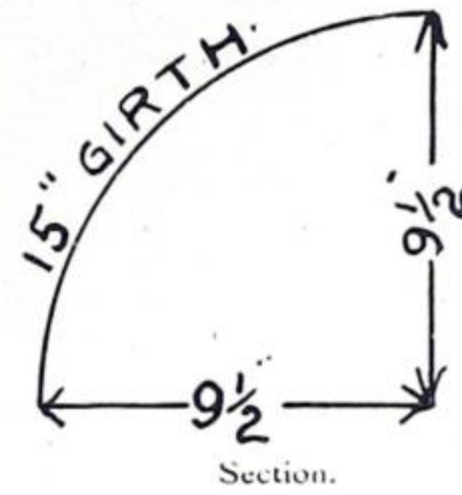

Inside mitre for
No. 300 Cove.



Outside mitre for
No. 300 Cove.



Cove Cornice No. 301.—24-inch girth.
Can be supplied any girth from 17 to 24 inches.
Use No. 926 moulding for covering mitres on this Cove.

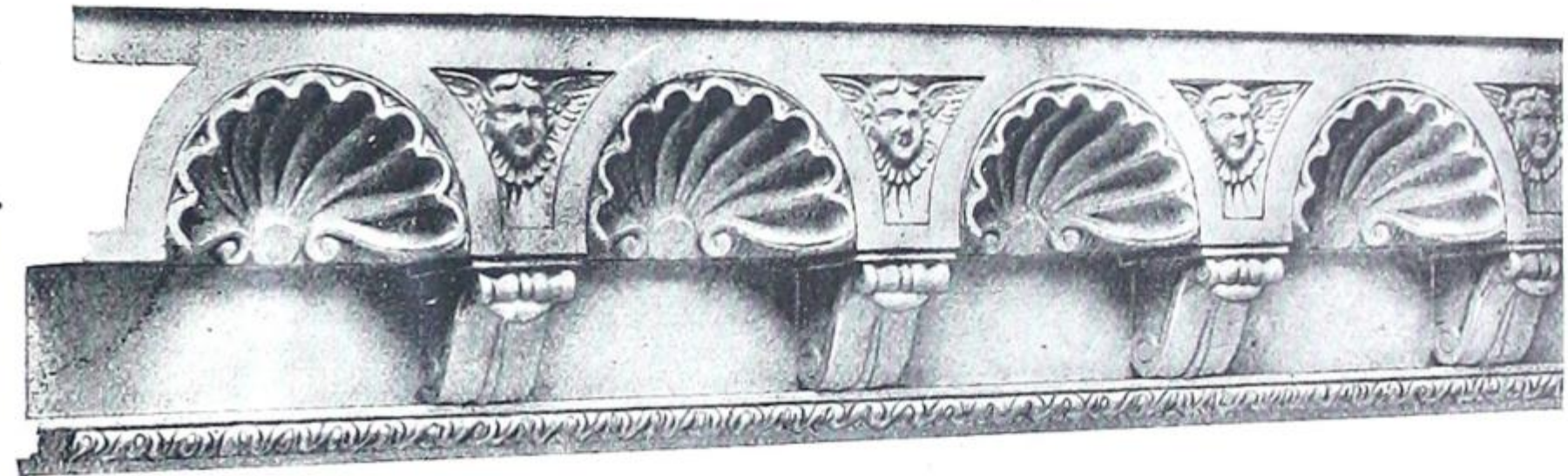
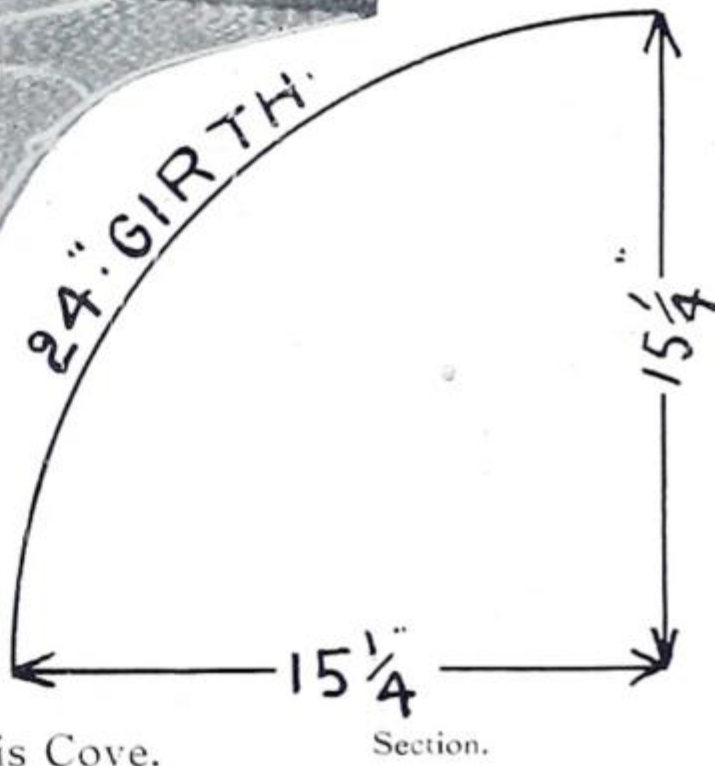

“Roman” Cornice No. 340.

Projection, 6 inches ; depth, 16 inches ; recedes 5 inches.

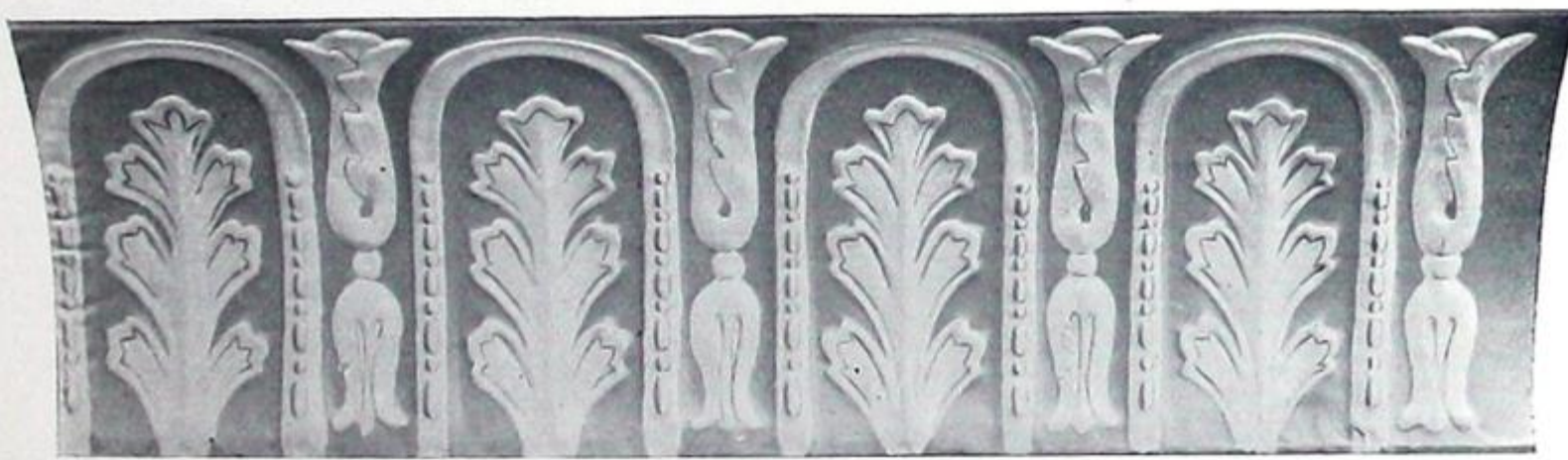

Cove Cornice No 302.
9½-inch girth.



Inside mitre for
No. 302 Cove.



Outside mitre for
No. 302 Cove.

Cornices.

SHELL PATTERN.



Cove Cornice No. 303.
13, 14 or 15-inch girth.

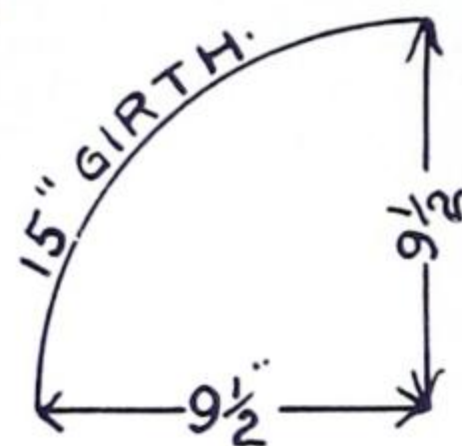

Section.

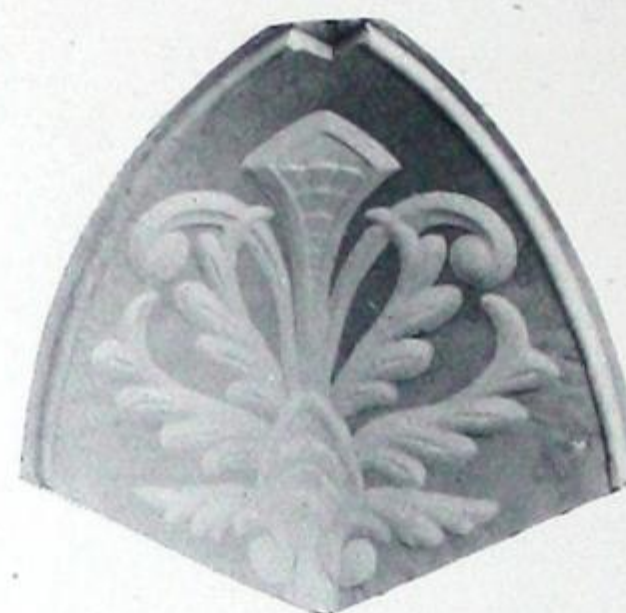

Inside mitre for
No. 303 Cove.



Outside mitre for
No. 303 Cove.



Cornice No. 304.
4-inch projection by 5 inches deep.
Also supplied with 6 to 12-inch filling on ceiling.

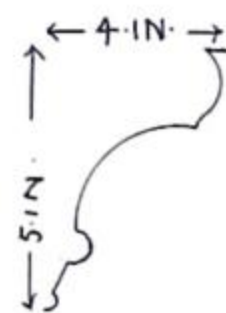

Section.



Inside mitre for
No. 304 Cornice.



Outside mitre for
No. 304 Cornice.



Cornice No. 305.
2 1/2-inch projection by 2 1/2 inches deep.

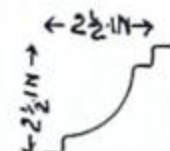

Section.



Inside mitre for
No. 305 Cornice.



Outside mitre for
No. 305 Cornice.

Cornices.



Design Rd. 1899

Cornice No. 337.

Projection, 6 inches ; depth, 6 inches.



Section.



Inside mitre for
No. 337 Cornice.



Outside mitre for
No. 337 Cornice.



Cornice No. 338.

Projection, 3 inches ; depth, 3 inches.



Section.



Inside mitre for
No. 338 Cornice.



Outside mitre for
No. 338 Cornice.

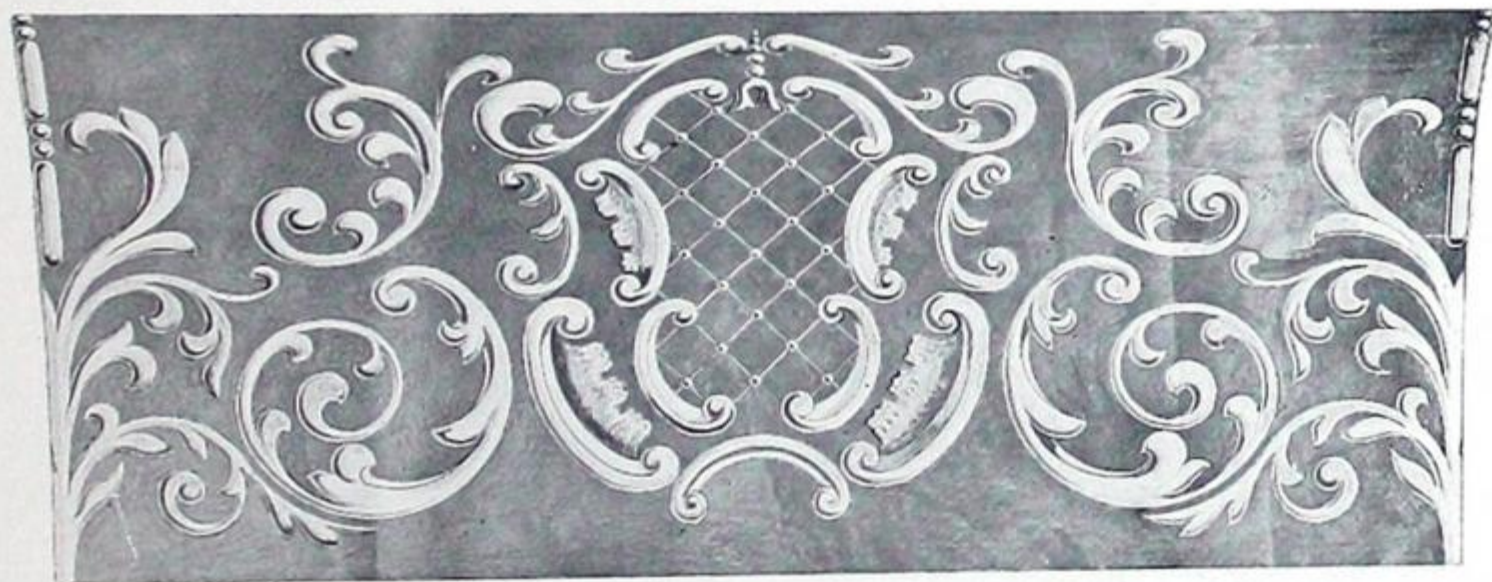

Design Rd. 1899.

Cove Cornice No. 339.

15-inch girth.

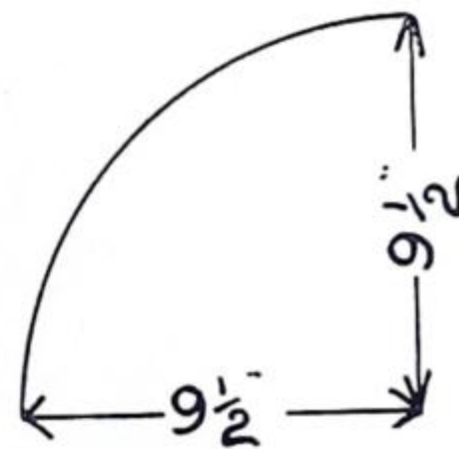

Section.



Inside mitre for
No. 339 Cove.



Outside mitre for
No. 339 Cove.

We can also make Cornices from plain steel formed to any detail.

Mouldings.

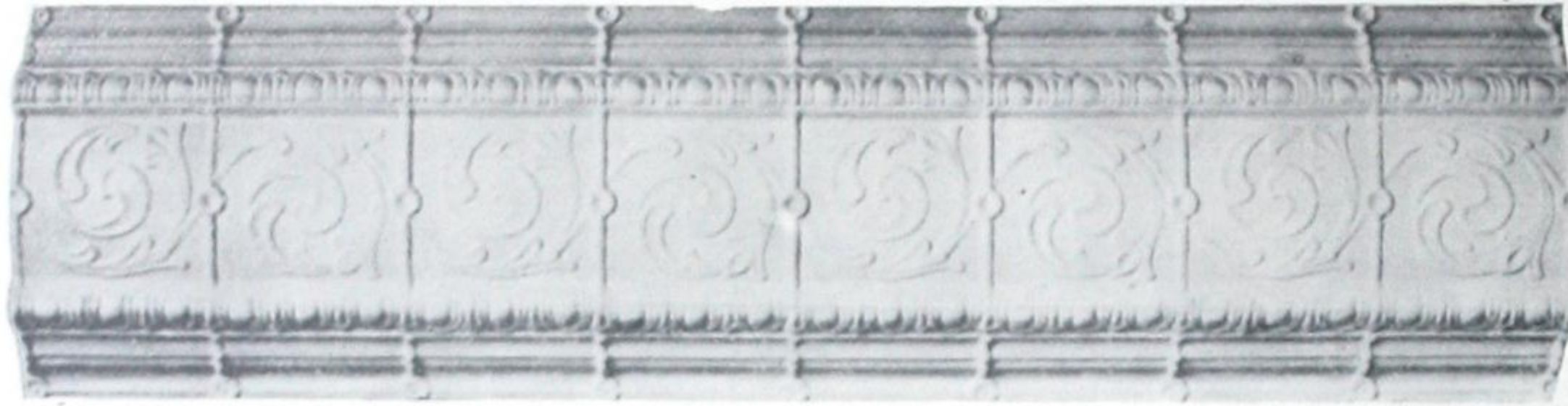

No. 900.—12-inch face, $2\frac{3}{4}$ -inch projection.

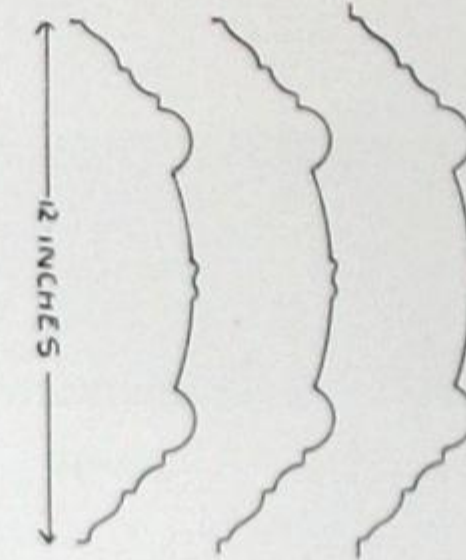

Section.



Cross No. 901.—12x12x $2\frac{3}{4}$ inches.



Tee No 902.—12 x 12 x $2\frac{3}{4}$ inches.



Ell No. 903.—12x12x $2\frac{3}{4}$ inches.

These mouldings are used to divide off ceiling plates into sections, so as to produce deep panelled effects, or to divide field and border plates; also in connection with centres, as shown elsewhere.



No. 904.—12-inch face, 2-inch projection.

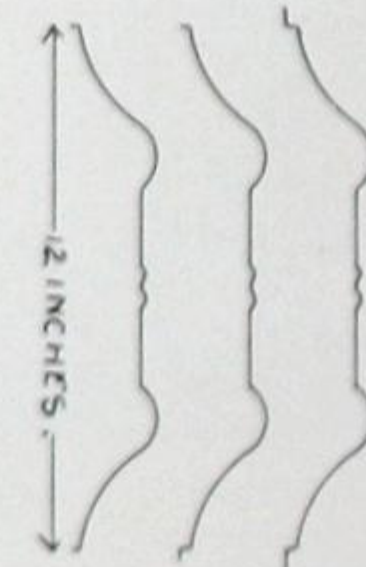

Section.



Cross No. 905.—12 x 12 x 2 inches.

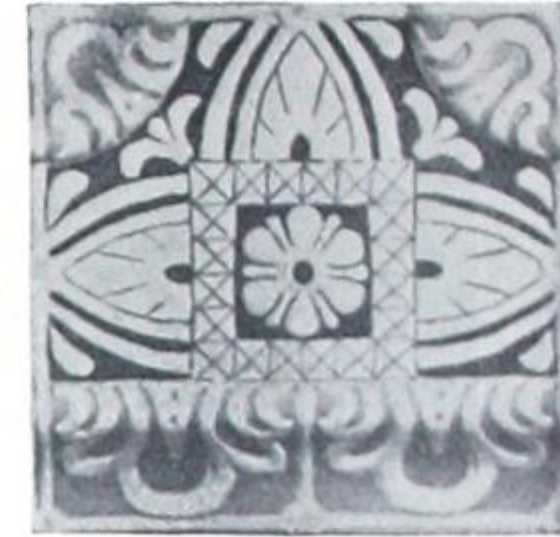

Tee No. 906.—12 x 12 x 2 inches.



Ell No. 907.—12 x 12 x 2 inches.

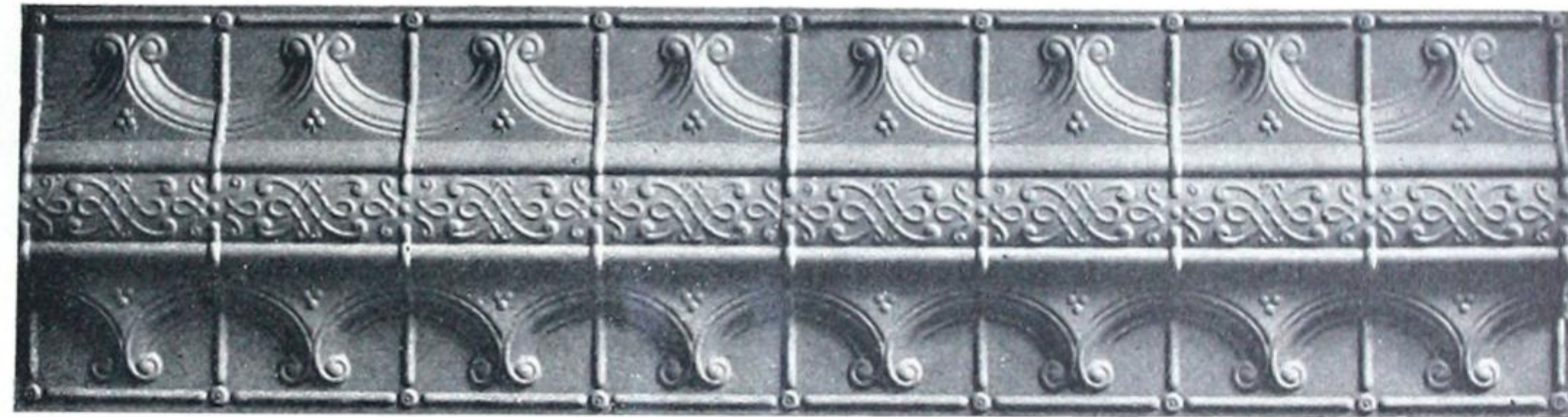

No. 941.—12-inch face, 2-inch projection.



Cross No. 942.—12 x 12 x 2 inches.



Tee No. 943.—12 x 12 x 2 inches.



Ell No. 944.—12 x 12 x 2 inches.

Mouldings.



No. 908.

6 inch face, $1\frac{1}{4}$ inch projection.



Section.



Stop Block No. 909.

6 x 6 x $1\frac{1}{4}$ inches.



No. 910.

6 inch face, $2\frac{1}{8}$ inch projection.

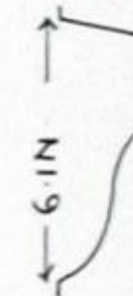

Section.



Ell No. 911.

6 x 6 x $2\frac{1}{8}$ inches.



Foot Moulding No. 912.— $5\frac{1}{2}$ inch face, 2 inch projection.

For finishing at the bottom of cornices, etc.

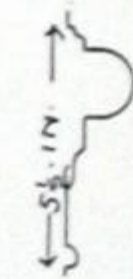

Section.



Foot Moulding No. 913.

4 inch face, $1\frac{3}{4}$ inch projection.



Section.

Mouldings.



No. 914.

8 1/2 inches wide, 1 inch projection. Can also be made up to 11 inches wide.



No. 918.

(ROPE.) 2 inches wide, 1 inch projection.

Section.



No. 919.

(ROPE.) 1 1/2 inches wide, 3/4 inch projection.

Section.

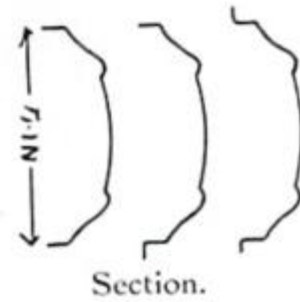
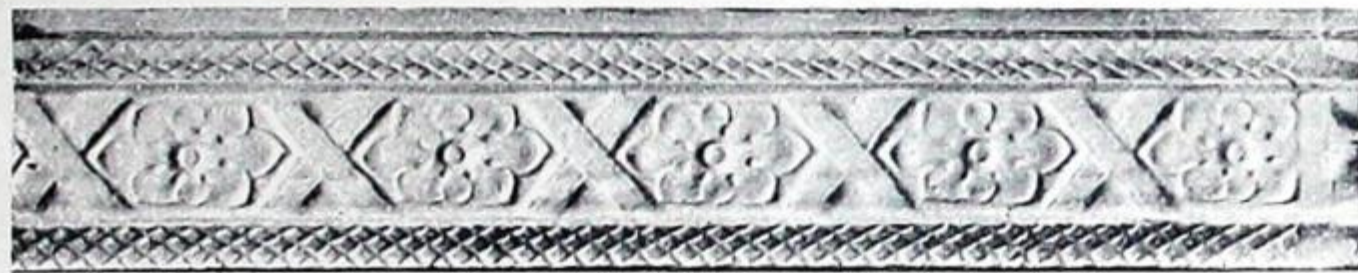

No. 915.

5 inches wide, 1 1/2 inches projection.

Section.

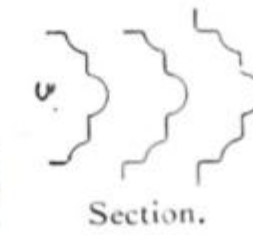

No. 920. 3 inches wide, 1 1/2 inch projection.

Section.

No. 921. 2 inches wide, 1 1/8 inch projection.



Section.

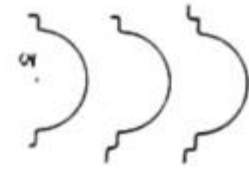

No. 916.

(ROPE.) 3 inches wide, 1 1/2 inch projection.

Section.



Foot Moulding No. 922.

3 inches wide.

Section.



No. 917.

(ROPE.) 2 1/2 inches wide, 1 1/4 inch projection.

Section.



Dado Capping No. 923.

5 inches wide, 1/2 inch projection.

Section.

Mouldings.



No. 924.— $3\frac{1}{4}$ inches wide, $\frac{7}{8}$ -inch projection.

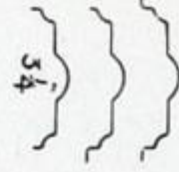

Section.



No. 925.—2 inches wide, $\frac{7}{8}$ -inch projection.



Section.



No. 926.— $\frac{3}{4}$ -inch wide.
For covering mitres of cornices, borders, etc.



Stop Block for No. 914 moulding.



Stop Block for No. 915 moulding.



Stop Block for Nos. 916, 920 and 924 mouldings.



Stop Block for No. 917 moulding.



Stop Block for Nos. 918, 921 and 925 mouldings.



Stop Block for No. 919 moulding.



No. 927.— $2\frac{1}{2}$ inches wide ;
 $1\frac{1}{4}$ -inch projection.

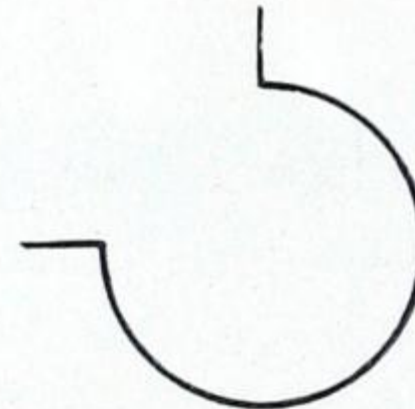

No. 928.—For angles of beams ;
any size to suit.

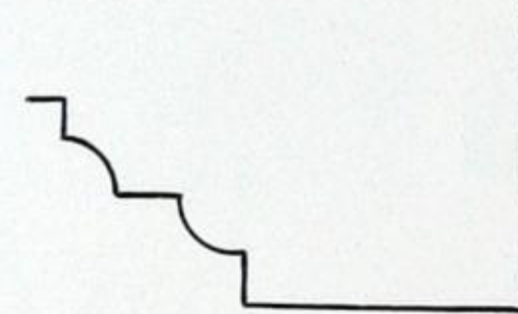

No. 929.—Angle moulding ;
any size to suit.

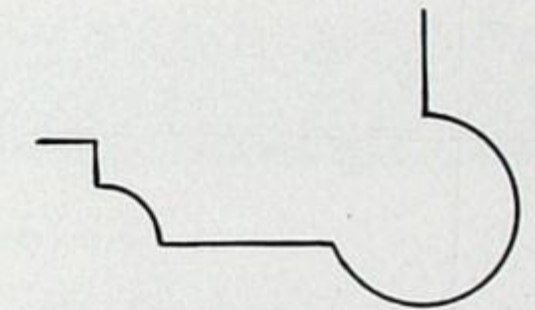

No. 930.—Angle moulding ;
any size to suit.



No. 931.—Angle moulding ;
any size to suit.

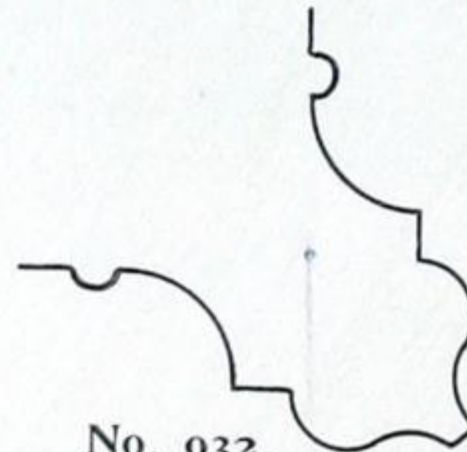

No. 932.
Angle moulding ; any size to suit.

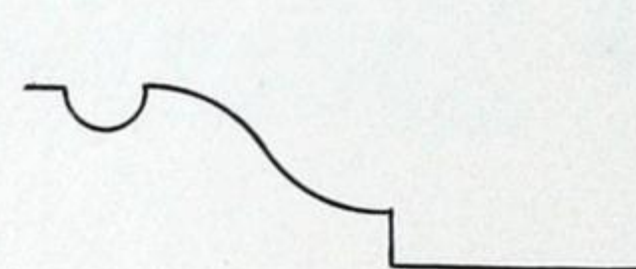

No. 933.—Angle moulding ;
any size to suit.

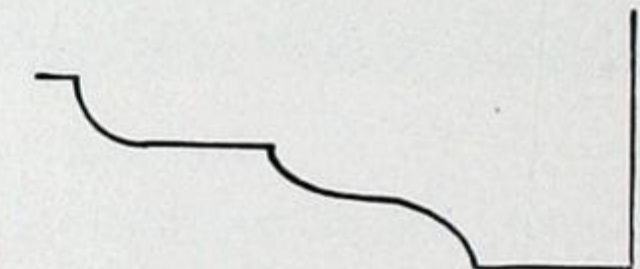

No. 934.—Angle moulding ;
any size to suit.

Beam or Girder Coverings.

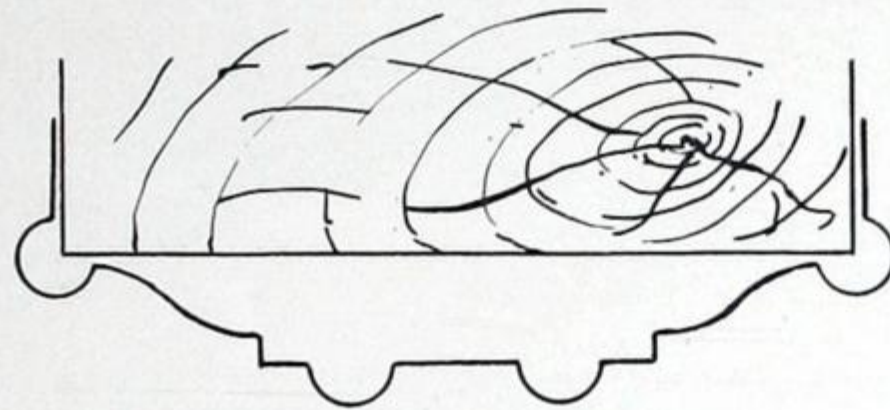

No. 935.
Any size to suit.

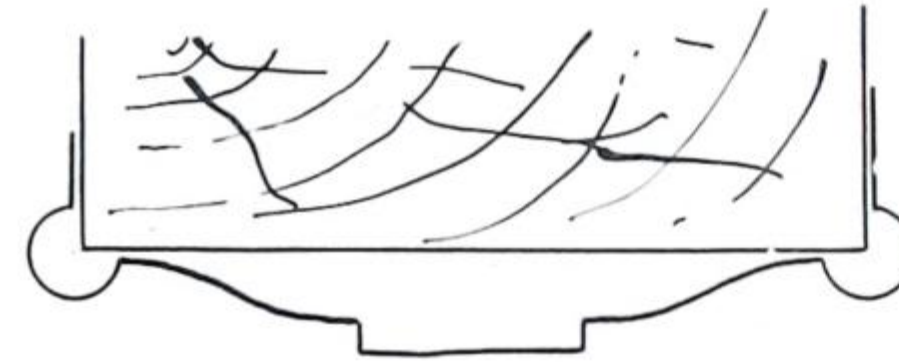

No. 938.
Any size to suit.

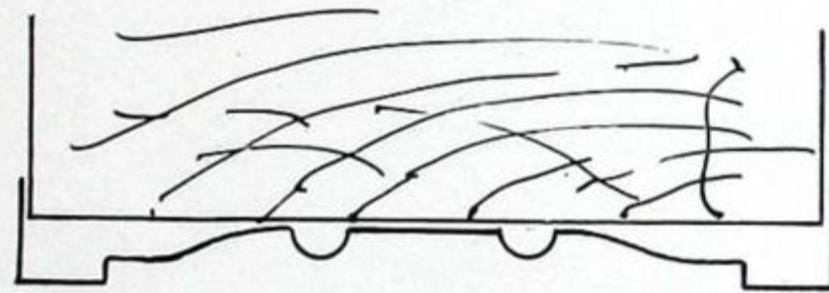

No. 936.
Any size to suit.

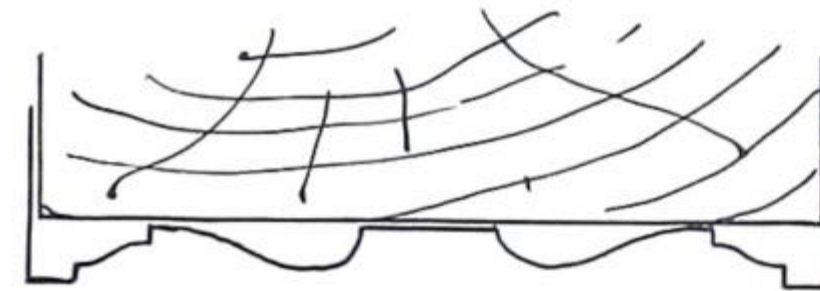

No. 939.
Any size to suit.

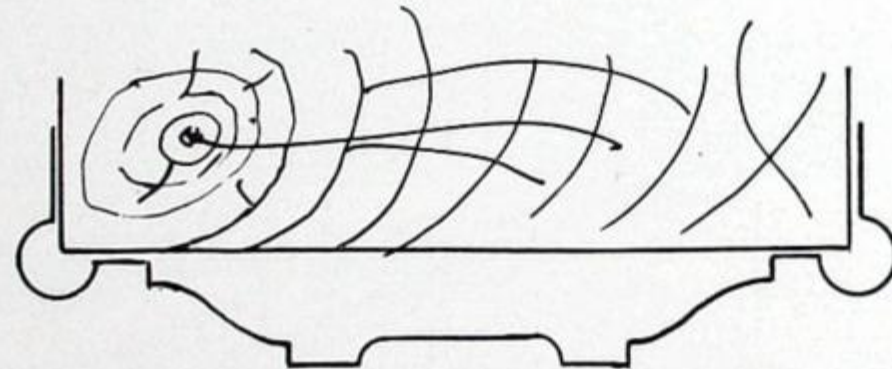

No. 937.
Any size to suit.



No. 940.
Any size to suit.

Beam or Girder Coverings.

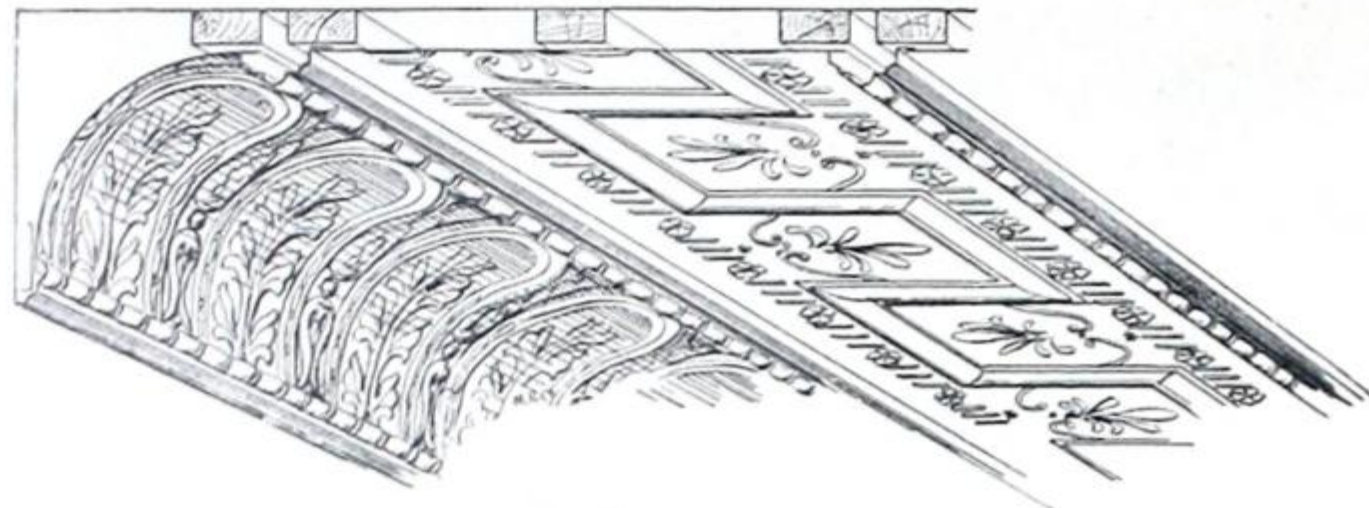

Fig. 3150.

Illustrates Cove No. 302, Embossed Mouldings No. 920, Embossed Foot Moulding, and Border No. 802, as put together to show the connection.

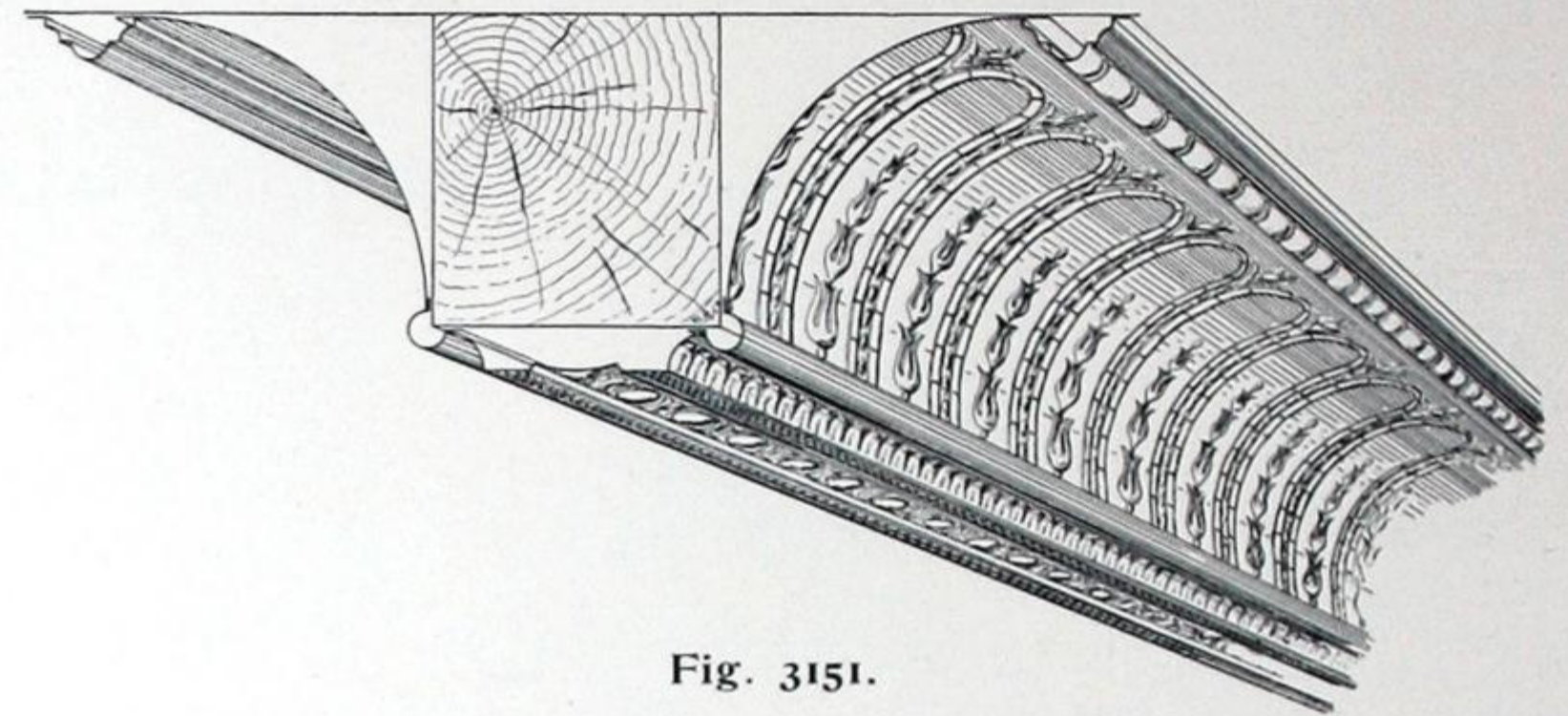

Fig. 3151.

Illustrates a beam covered on the sides with Cove No. 300, and on the soffit with Moulding No. 914, with suitable small mouldings at the angles, and embossed moulding at the top of cove.

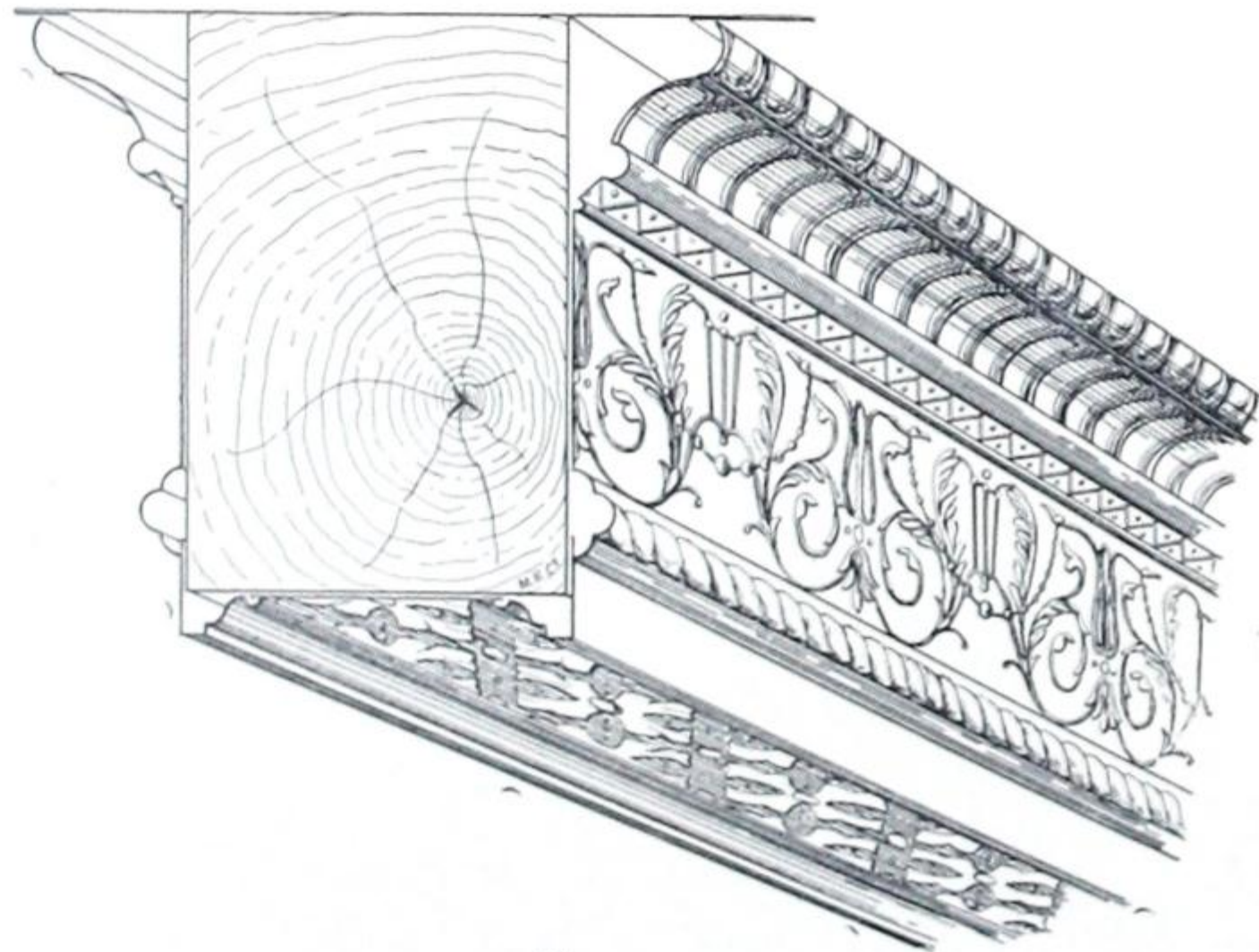

Fig. 3152.

Shows beam covered with combined Cornice and Frieze No. 809 on the sides, Diaper No. 812 on the soffit, with suitable mouldings on the angles.

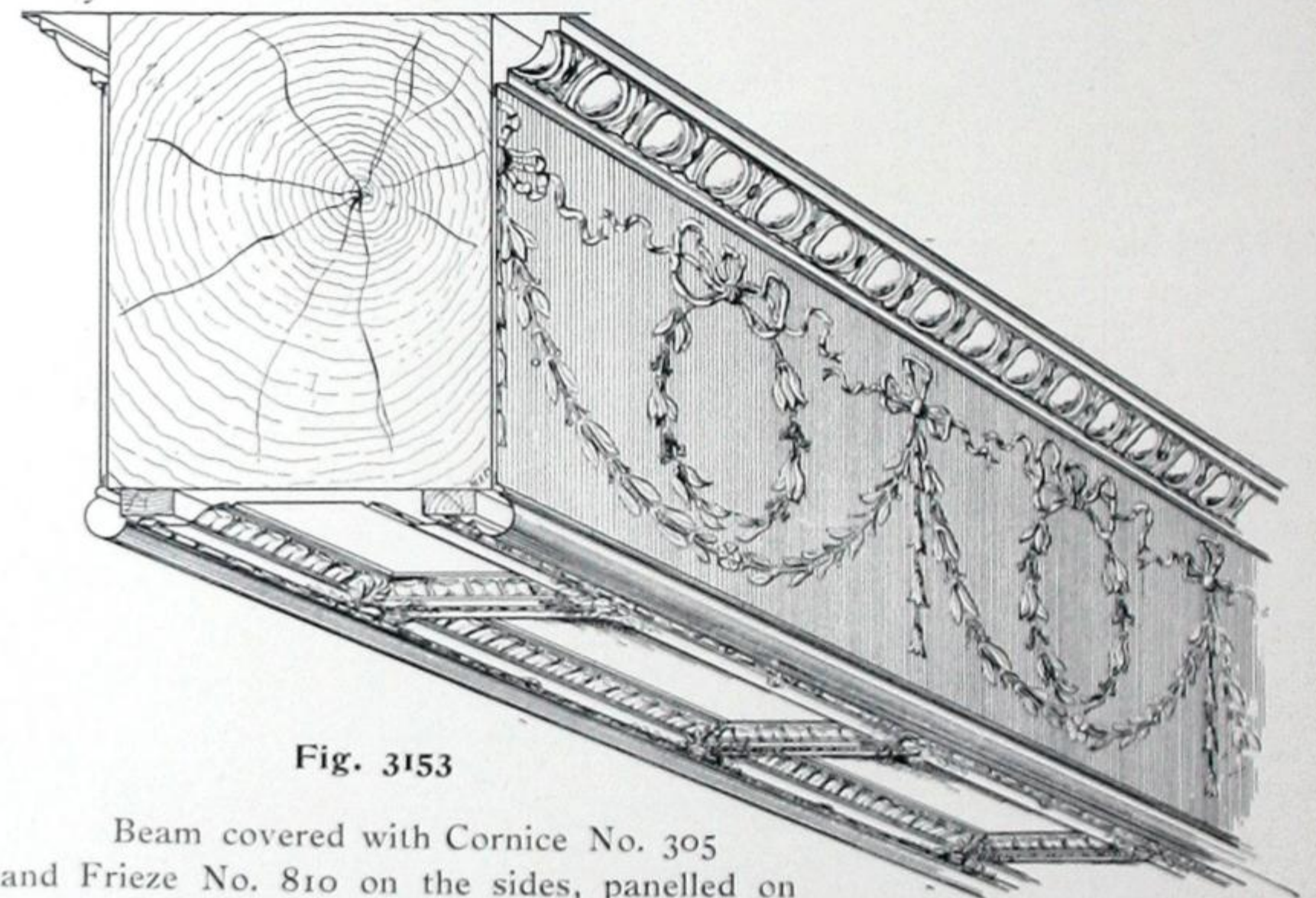

Fig. 3153

Beam covered with Cornice No. 305 and Frieze No. 810 on the sides, panelled on the soffit with Plates No. 402 and with small mouldings on the angles.

Beam or Girder Coverings.

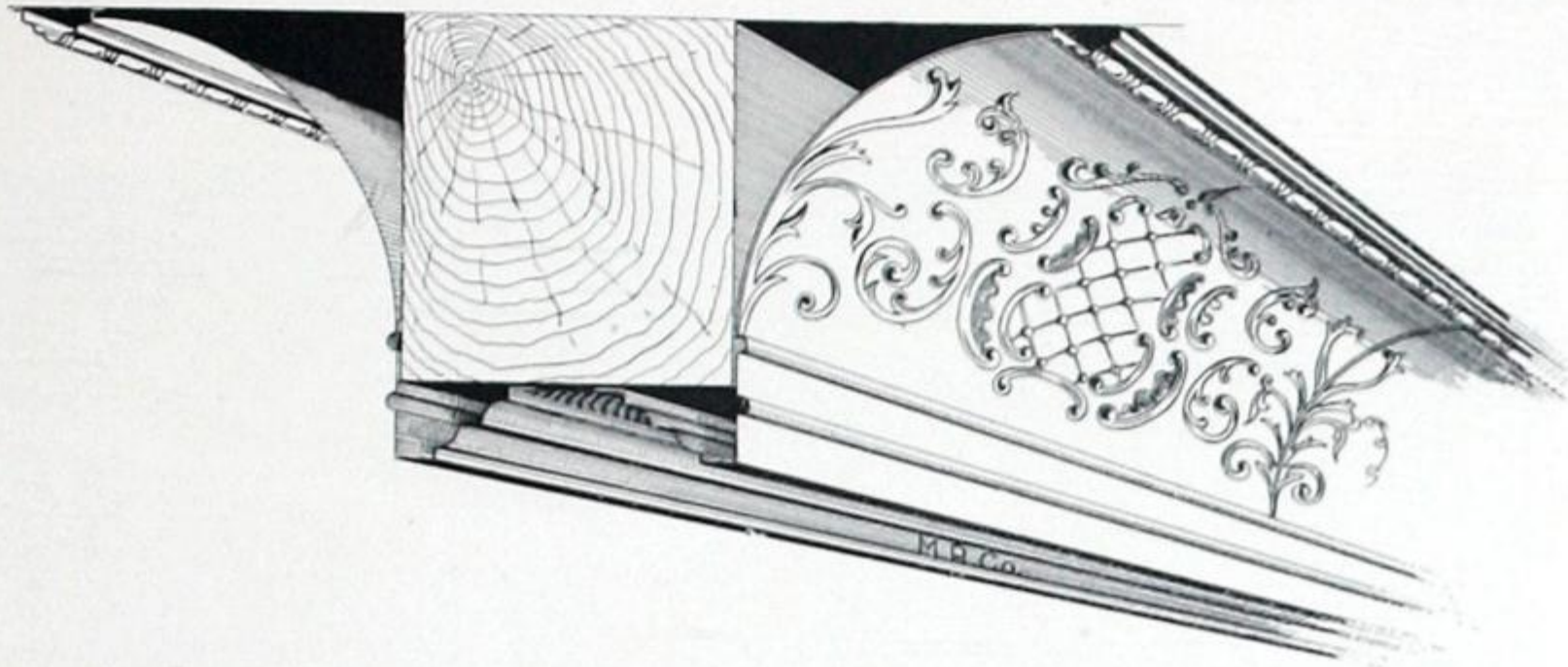

Fig. 3154.

Cove Cornice No. 339 on the sides, and special girder covering on the soffit.



Fig. 3155.

Cove Cornice No. 303 on the sides, No. 919 as a foot moulding, and special girder covering on the soffit.

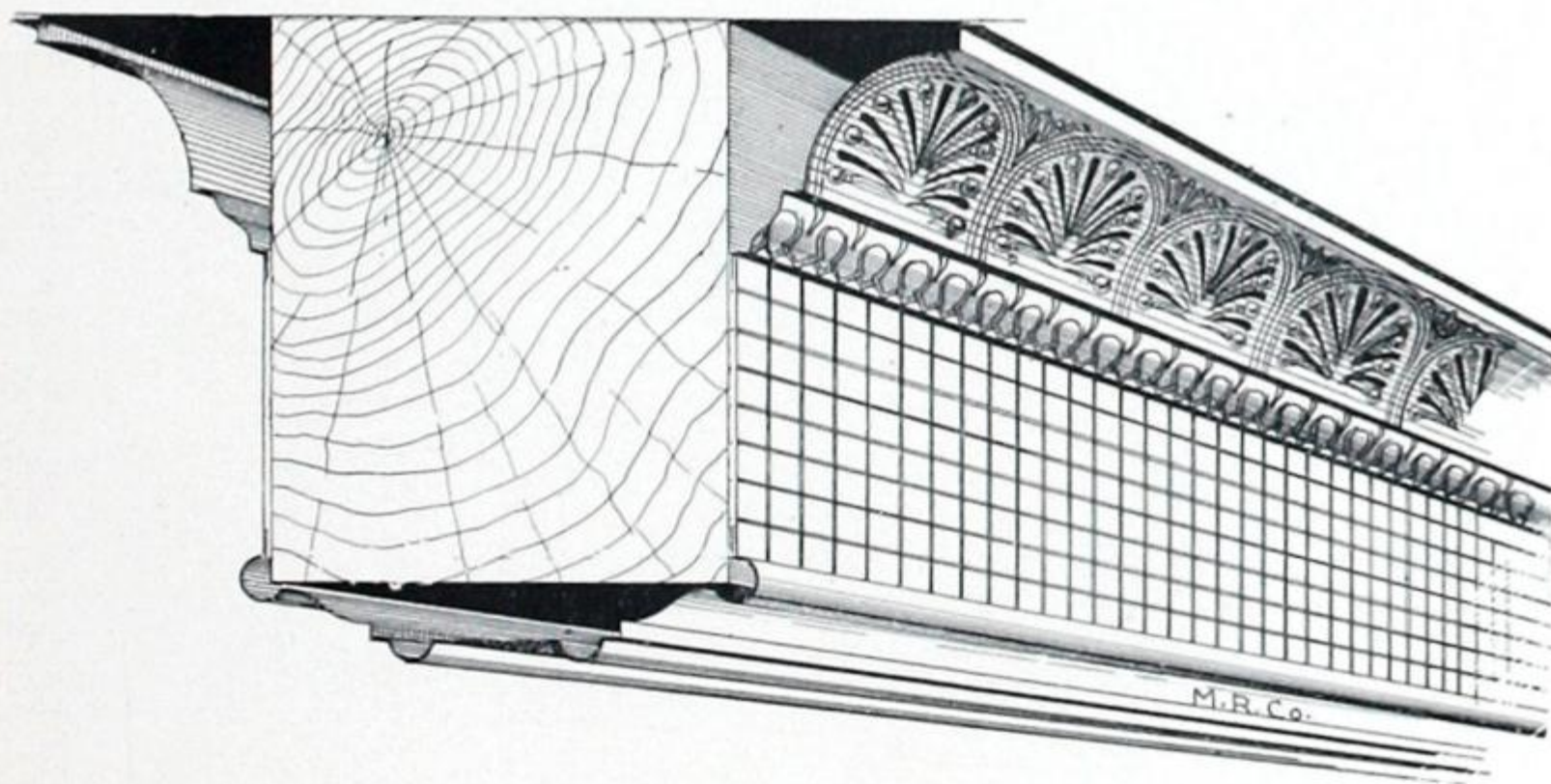

Fig. 3156.

Cornice No. 337 with Frieze of No. 813, and beam covering No. 937 on the soffit.

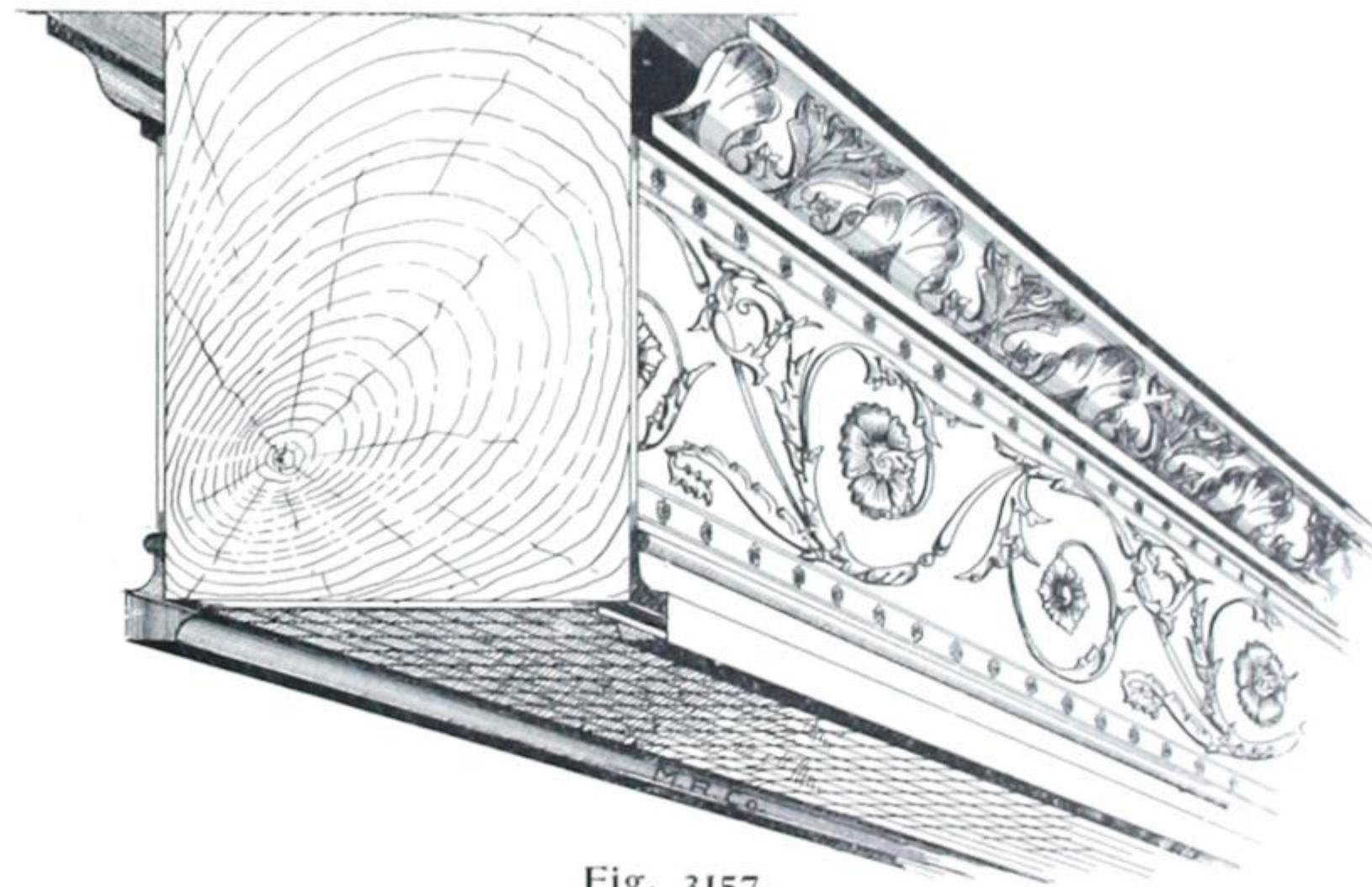

Fig. 3157.

Cornice No. 338, Frieze No. 811 on the sides, Special Angle Moulding, and No. 813 on the soffit.

Ceiling Plates.

ELIZABETHAN DESIGN.



Fig. 3000.

Plates No. 417. Section 4 x 4 feet,
Showing four plates put together. A beautiful and very bold design for
large rooms or high ceilings.

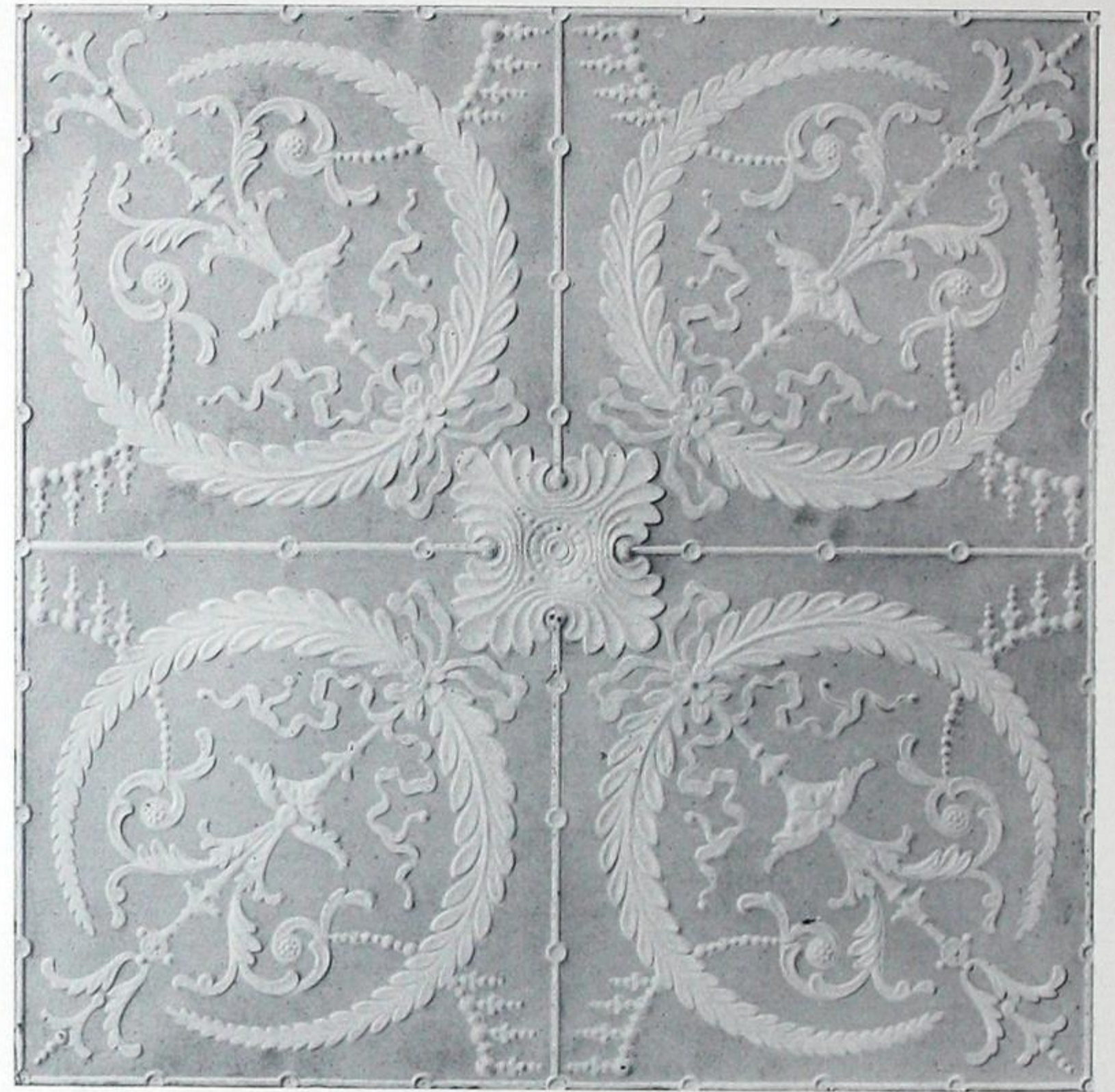

Fig 3001.

Plates No. 439. Section 4 x 4 feet,
Showing 4 plates put together.

Ceiling Plates.

“ROCOCO” DESIGN.

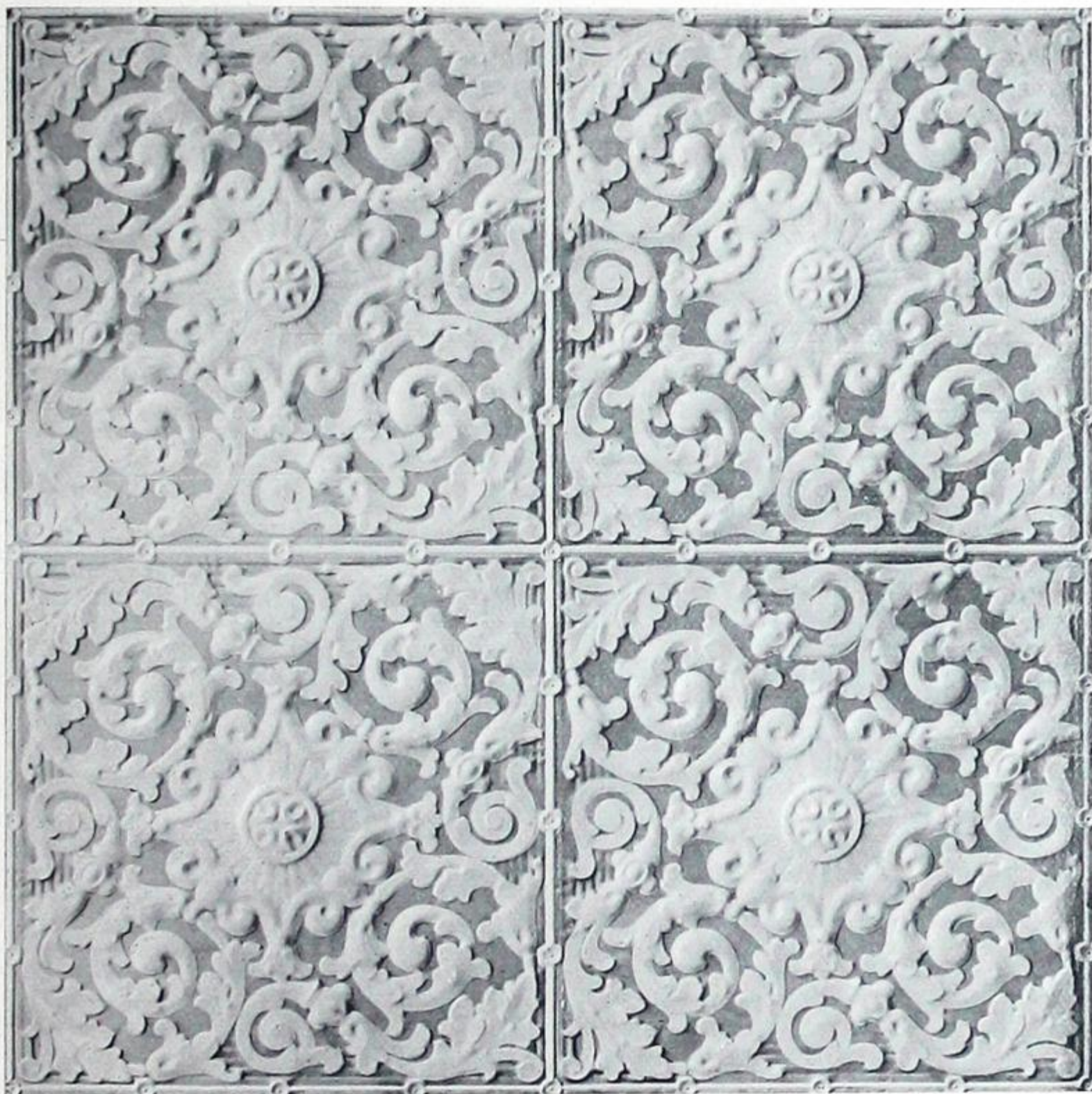

Fig. 3002.

Plates No. 440. Section 4 x 4 feet. Showing four plates put together.

“ROCOCO” DESIGN.

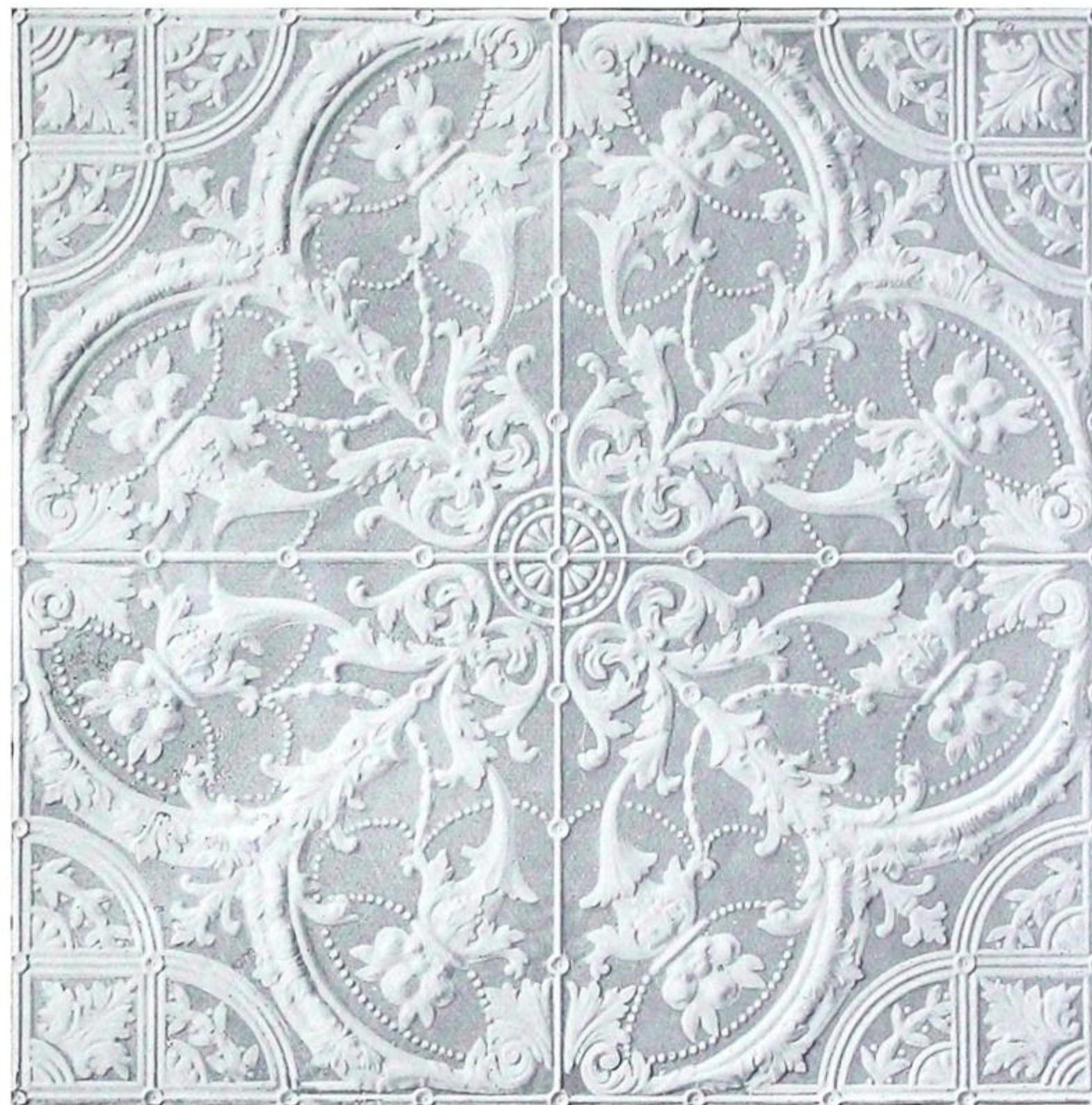

Fig. 3003.

Plates No. 441. Section 4 x 4 feet. Showing four plates put together.

Ceiling Plates.

“ROCOCO” DESIGN.

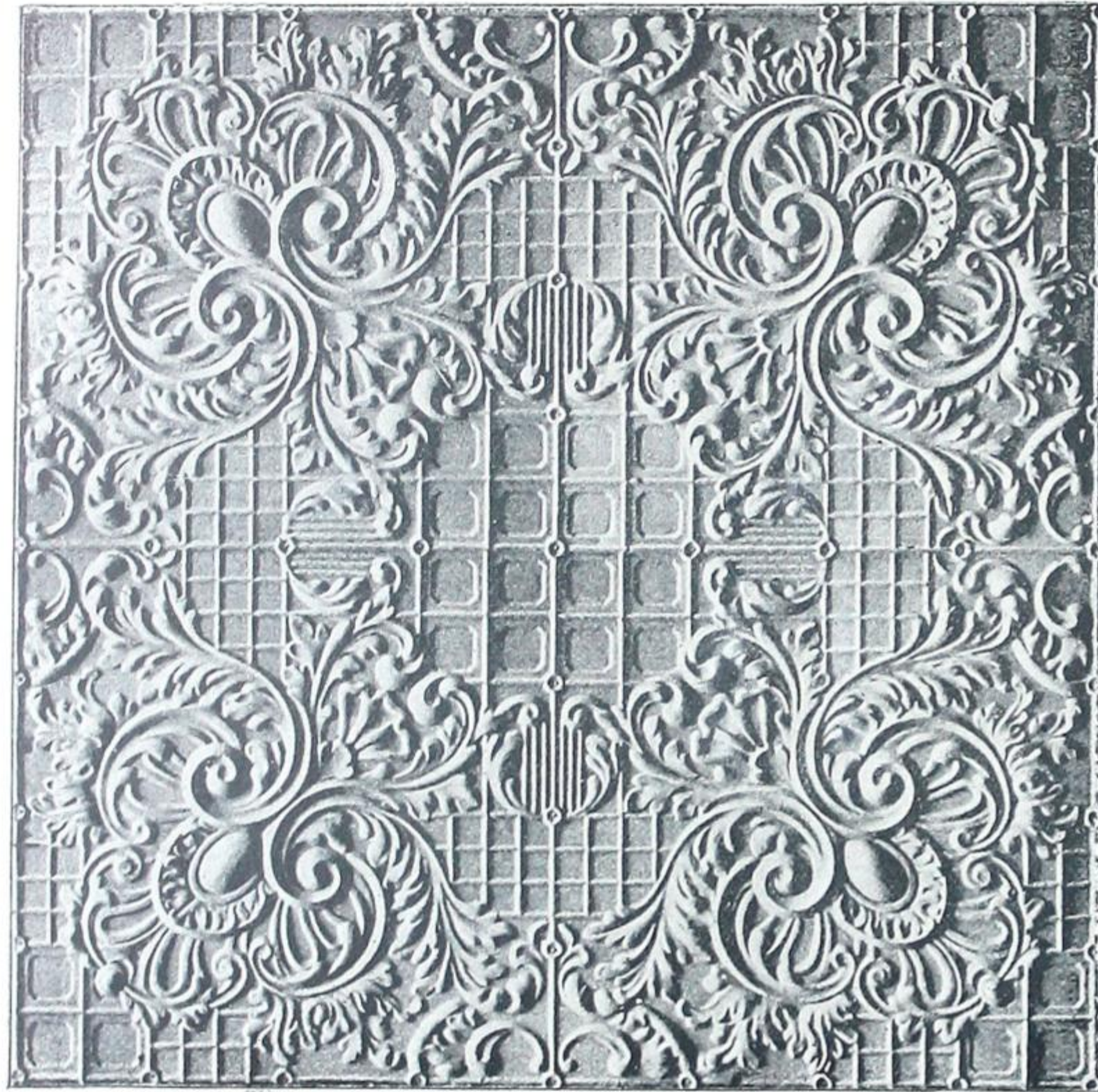

Fig. 3004.

Plates No. 443. Section 4 x 4 feet. Showing four plates put together.

“ROCOCO” DESIGN.

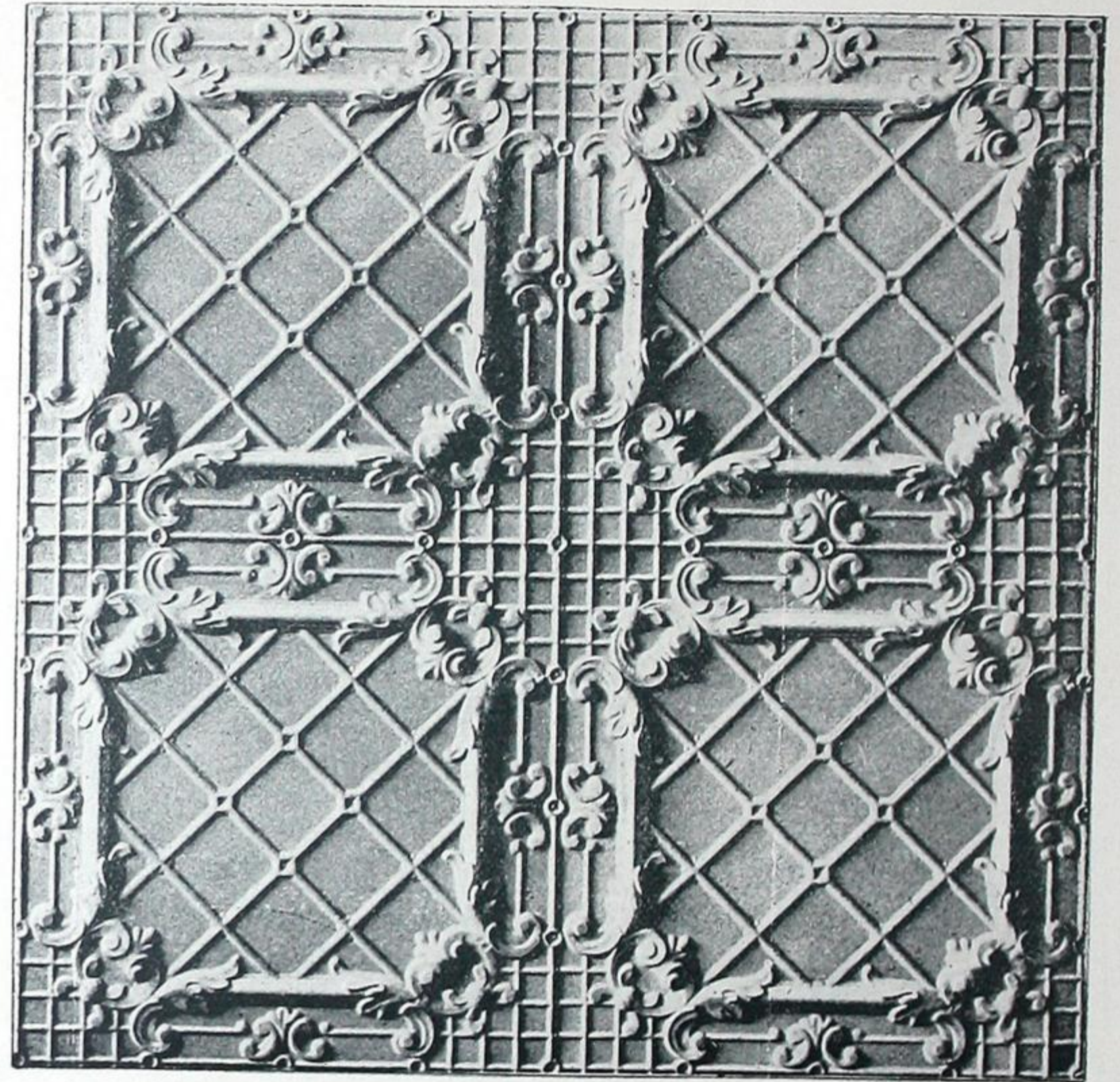

Fig. 3005.

Plates No. 444. Section 4 x 4 feet. Showing four plates put together.

Ceiling Plates.

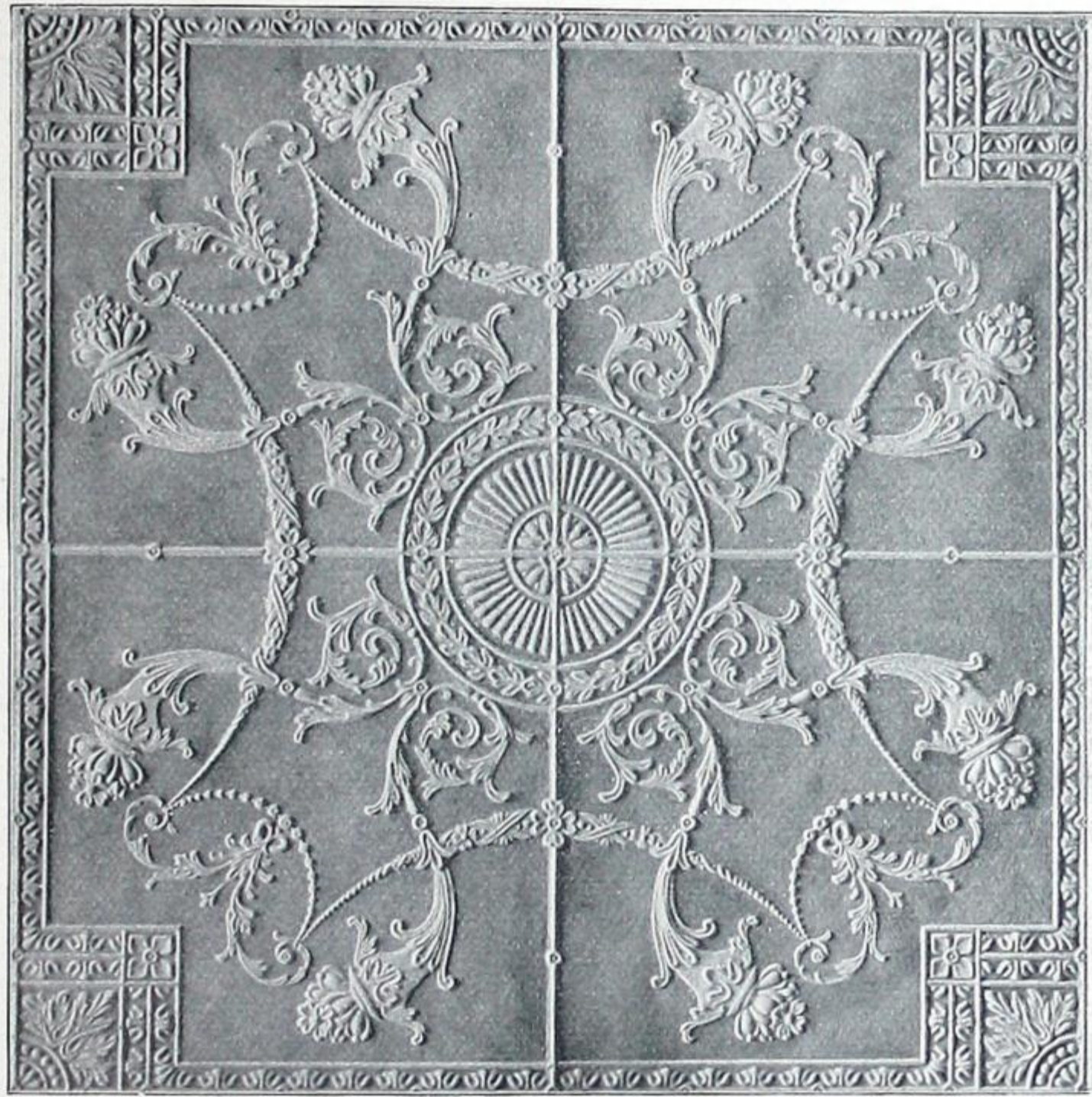

Fig. 3006.

Plates No. 445. Section 4 x 4 feet. Showing four plates put together.

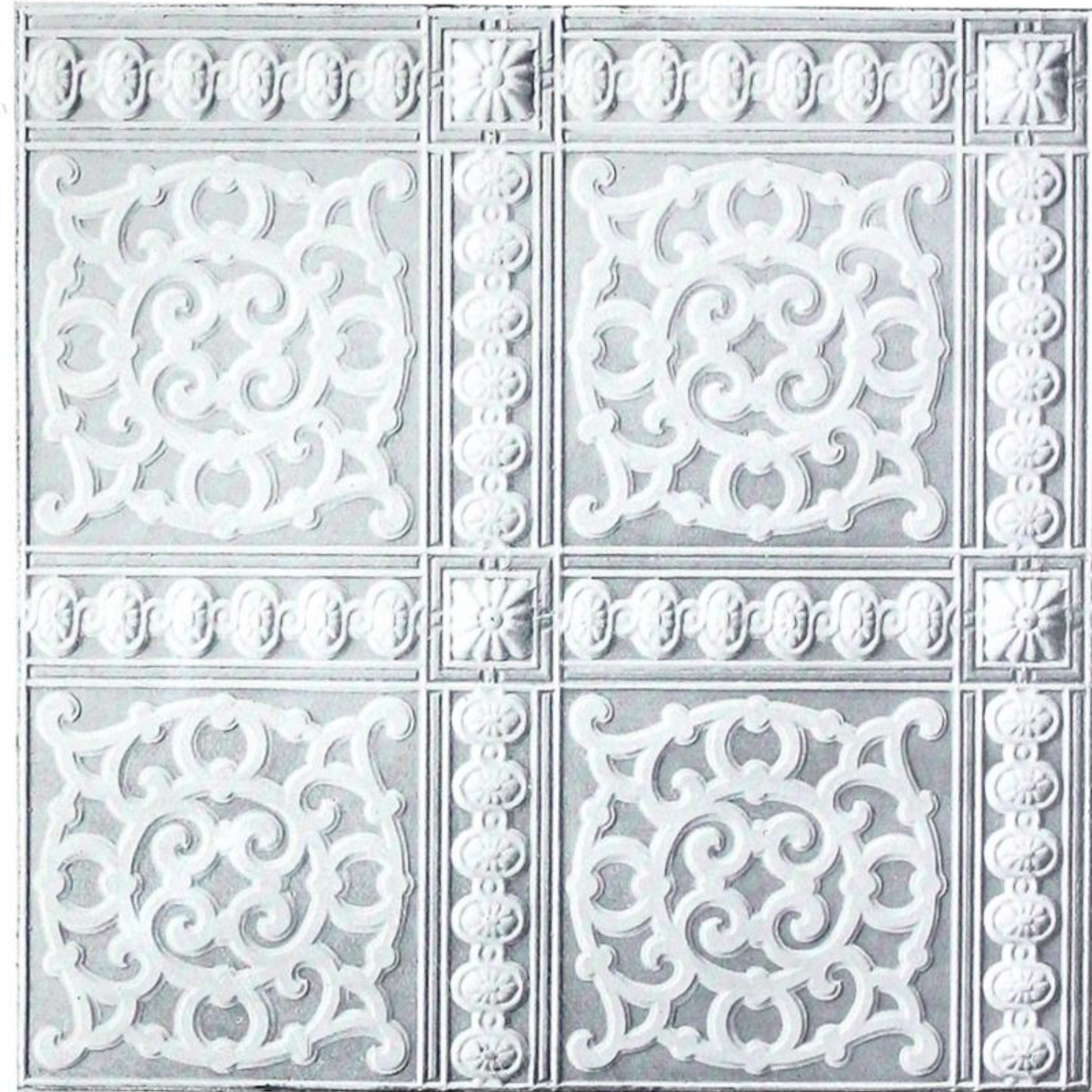

Fig. 3007.

Plates No. 476. Section 4 x 4 feet. Showing four plates put together.

THE METALLIC ROOFING COMPANY OF CANADA, LIMITED, TORONTO, CANADA.

Ceiling Plates.



Fig. 3008.—ENGLISH RENAISSANCE.

Plates No. 416. Section 4 feet 6 inches by 4 feet 6 inches, showing four plates put together.

Ceiling Plates.

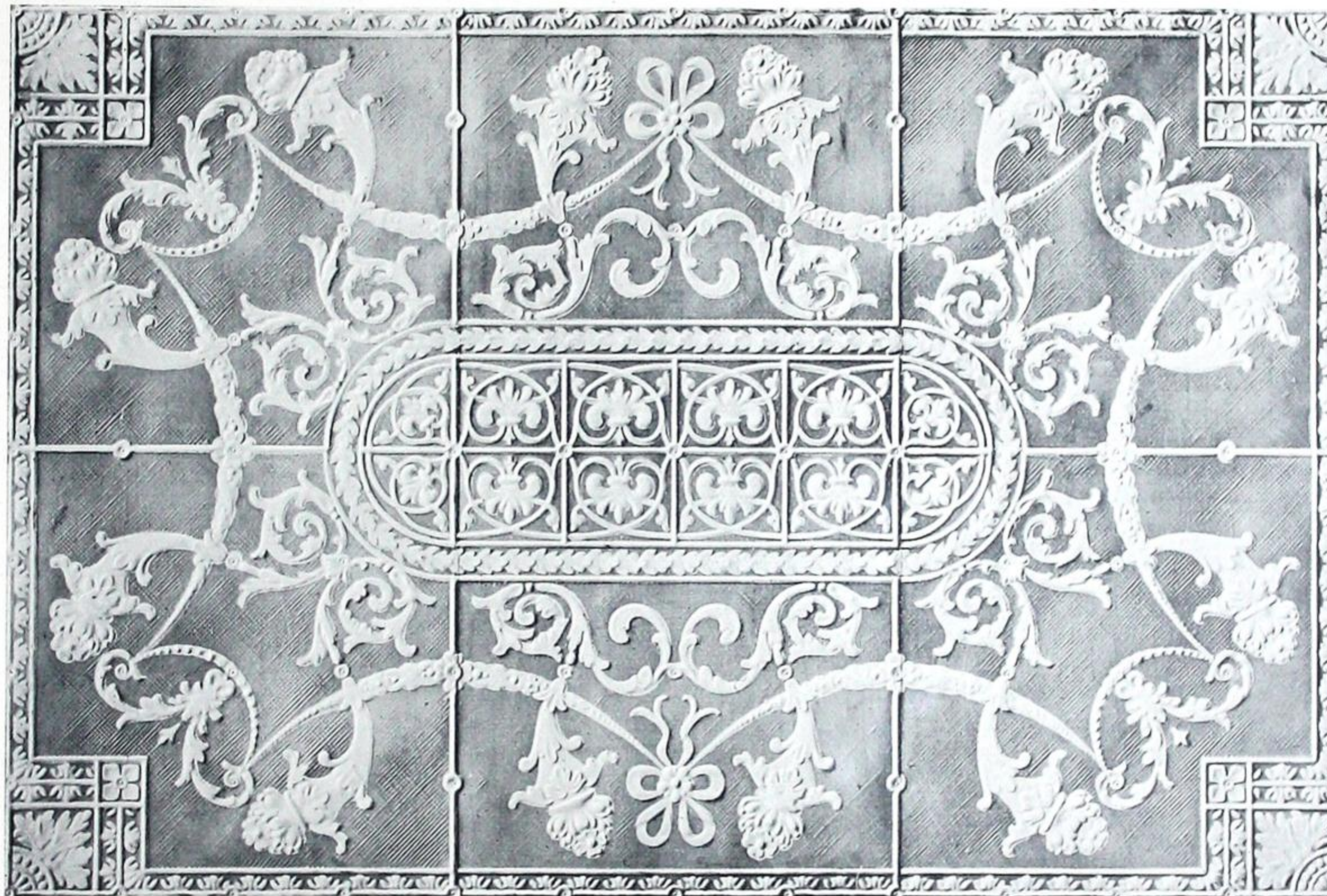

Fig. 3100.

Combination of Plates Nos. 445 and 446. Section 4 x 6 feet, showing six plates put together.



Ceiling Plates.



Fig. 3101.

Combination of Plates Nos. 441 and 442. Section 4 x 6 feet, showing six plates put together.

Ceiling Plates.

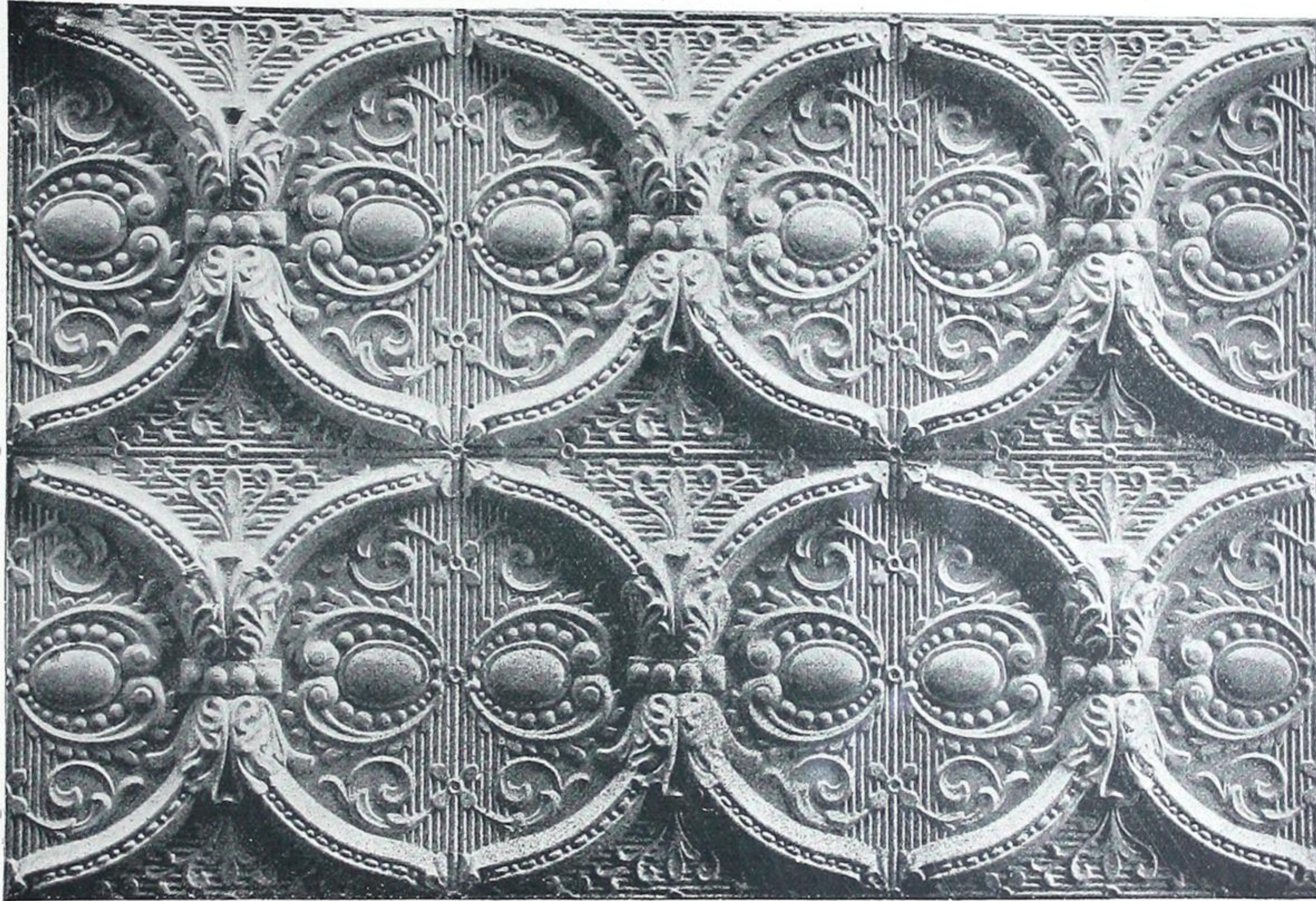

Fig. 3102.

Plates No. 477. Section 4 x 6 feet, showing six plates put together. Note the different combinations that may be made with this plate. See Figs. 3103 and 3104.



Ceiling Plates.

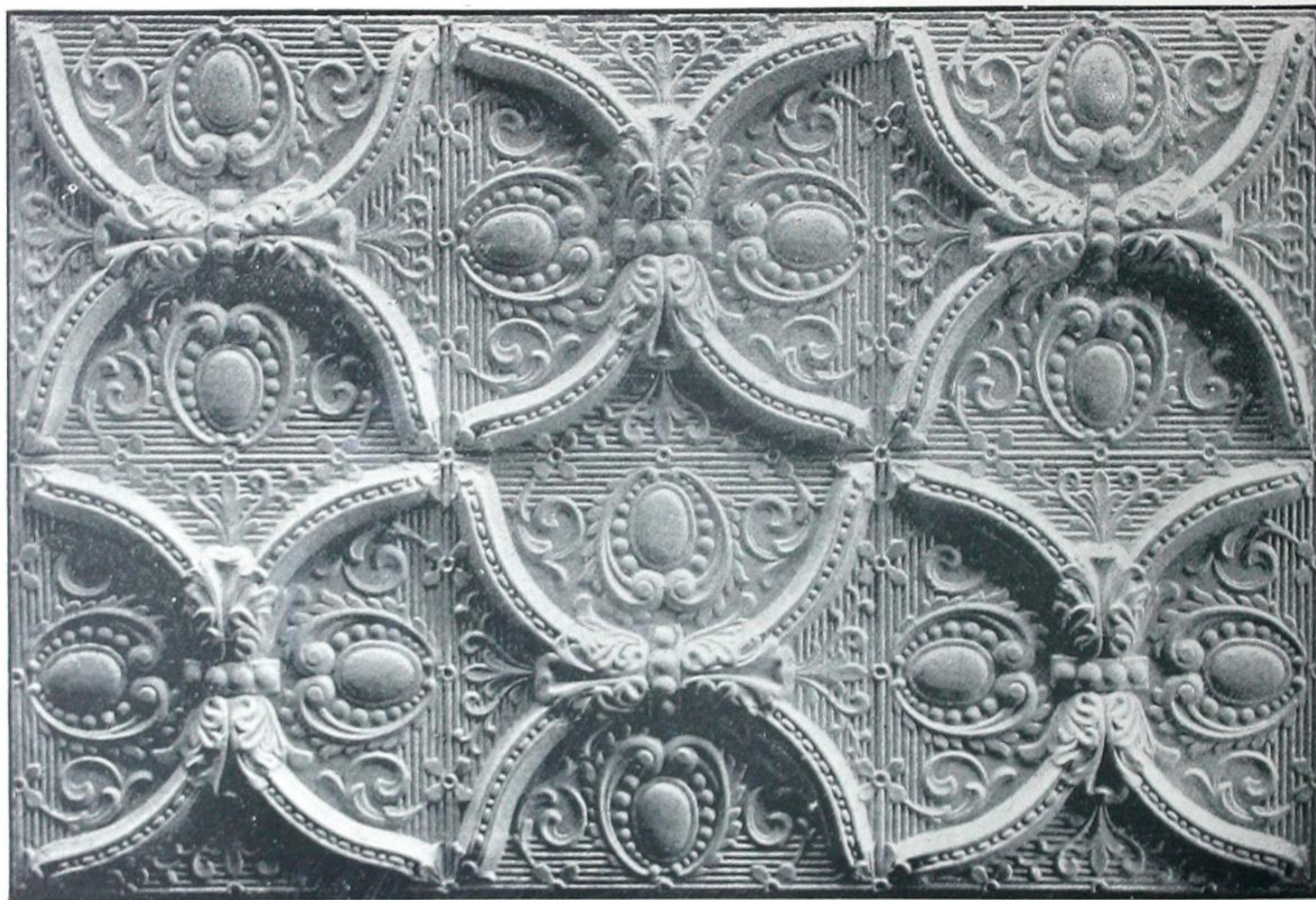

Fig. 3103.

Plates No. 477. Section 4 x 6 feet, showing six plates put together. Note the different combinations that may be made with this plate.
See Figs. 3102 and 3104.

Ceiling Plates.

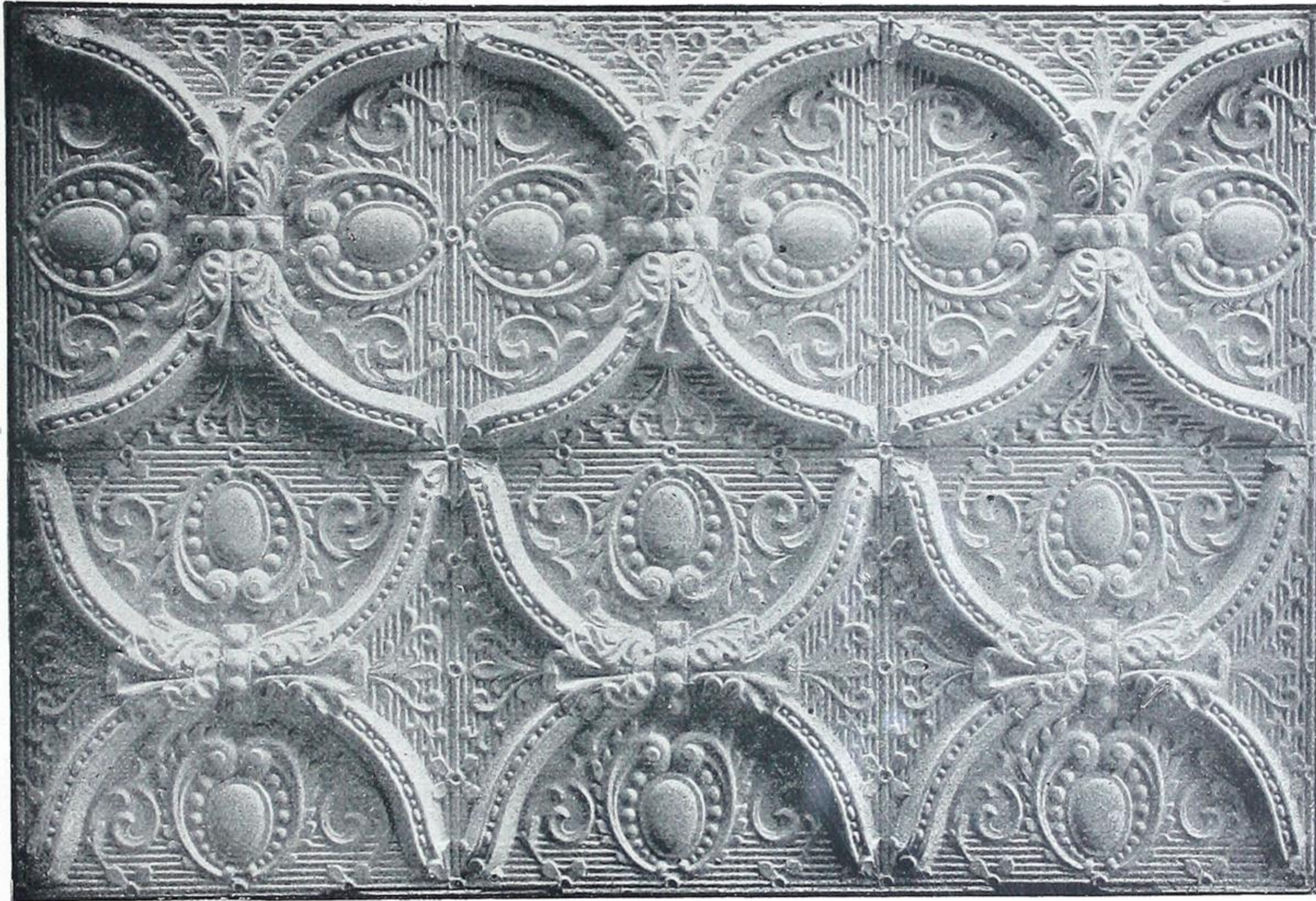

Fig. 3104.

Plates No. 477. Section 4 x 6 feet, showing six plates put together. Note the different combinations that may be made with this plate.
See Figs. 3102 and 3103.



Ceiling Design.

ELIZABETHAN DESIGN.



Fig. 3105. .

Section 4 feet by 6 feet 2 inches, showing combination of Plates Nos. 417, 488, and 489 put together. A very beautiful and effective panel for large ceilings, such as churches, public buildings, etc., etc. Design may be continuous, or panels may be divided off with heavy mouldings or false beams.

Dados.



Fig. 3200.

Shows combination of Plates Nos. 456
and 459.



Fig. 3201.

Shows combination of Plates Nos. 454,
457, 458.



Fig. 3202.

Shows combination of Plates Nos. 455
and 458.

Dados.



Fig. 3203.

Shows manner of applying Dado Plates up the rake of a staircase.
Plates Nos. 454 and 457.

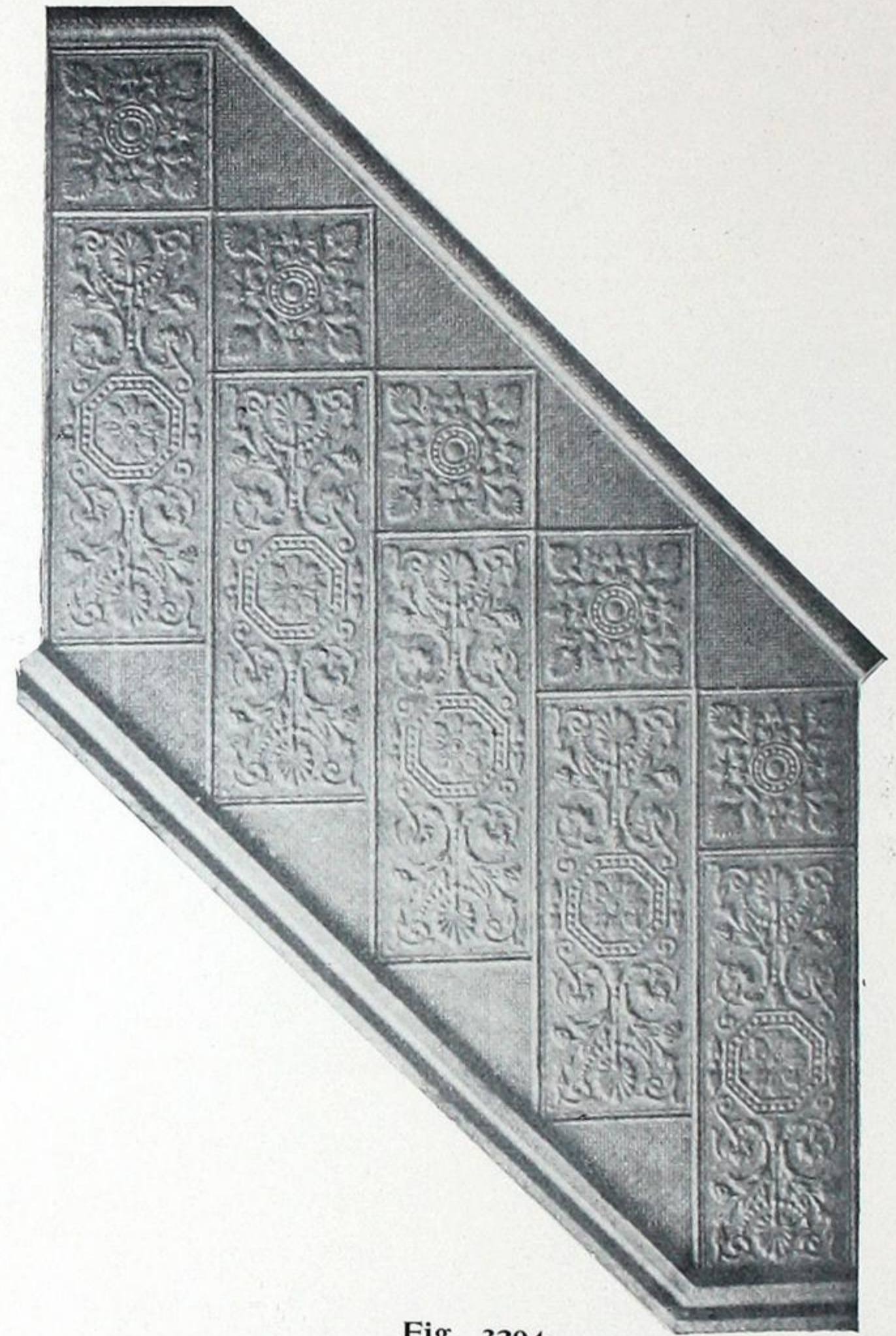

Fig. 3204.

Shows Plates Nos. 456 and 459 as applied up
the rake of a staircase.

Wall Designs.

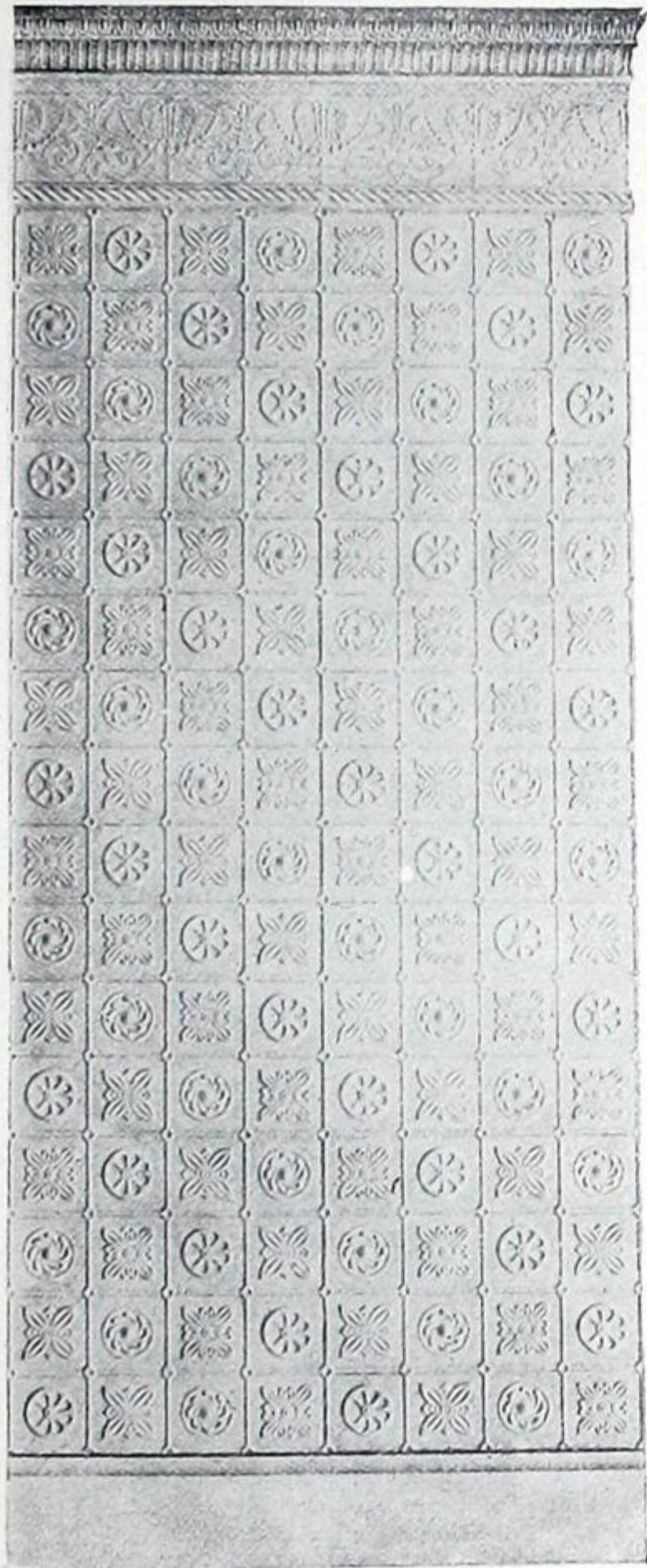

Fig. 3300.

Plates No. 437. Cornice and Frieze No. 809.

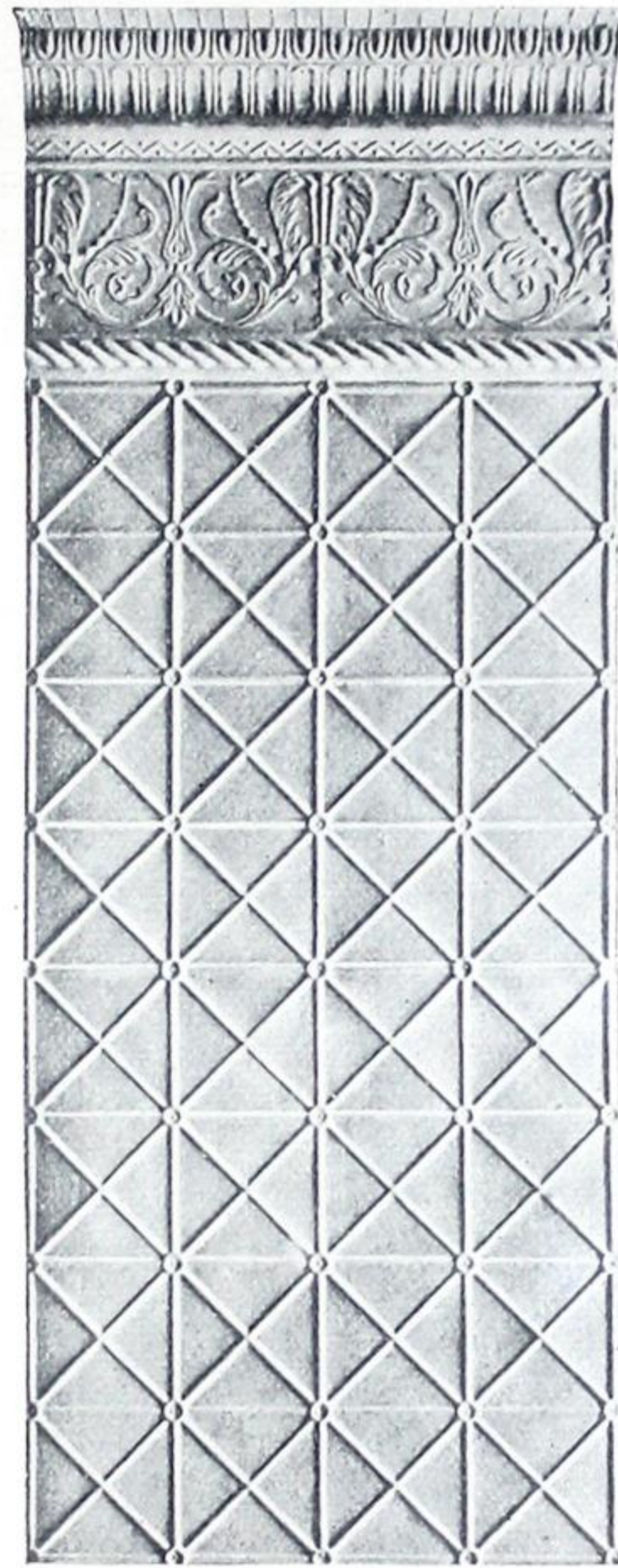

Fig. 3301.

Plates No. 435. Cornice and Frieze No. 809.



Fig. 3302.

Plates No. 436. Cornice and Frieze No. 809.



Wall Designs.

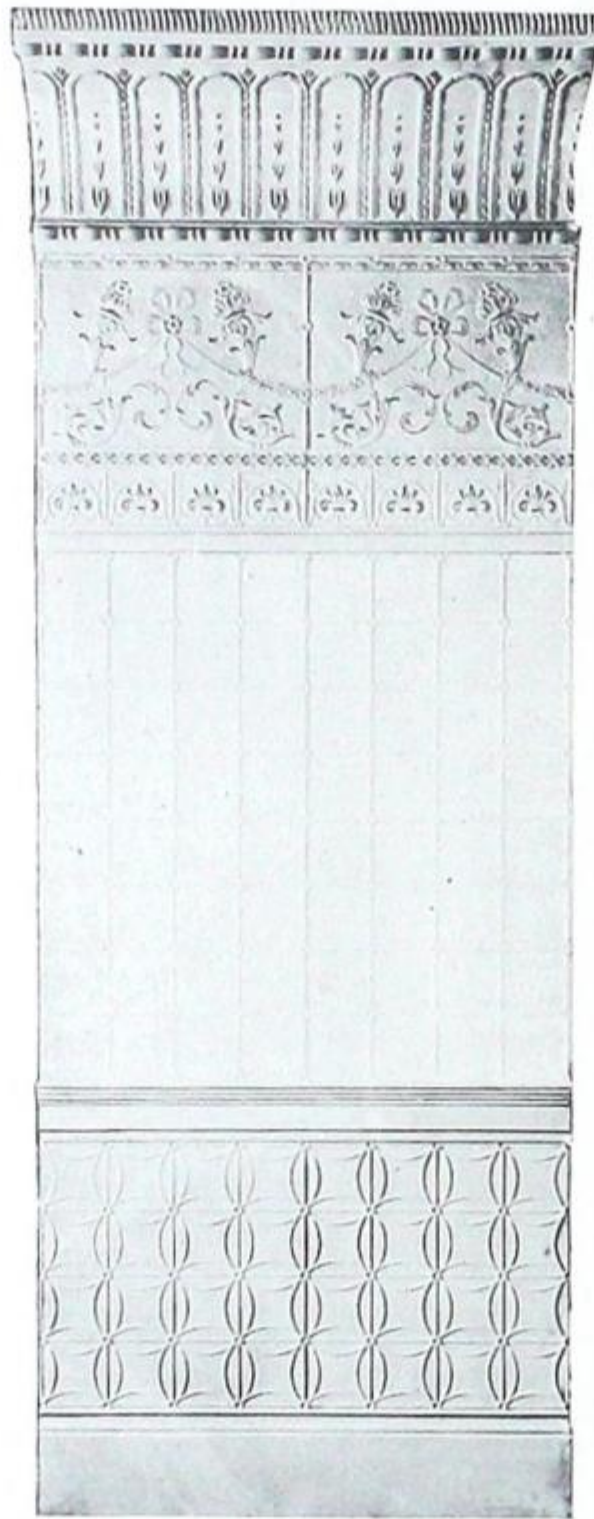

Fig. 3303.

Dado, Plates No. 432 ; Wall, Plates No. 436;
Frieze, " 446 ; Cove Cornice, " 300.

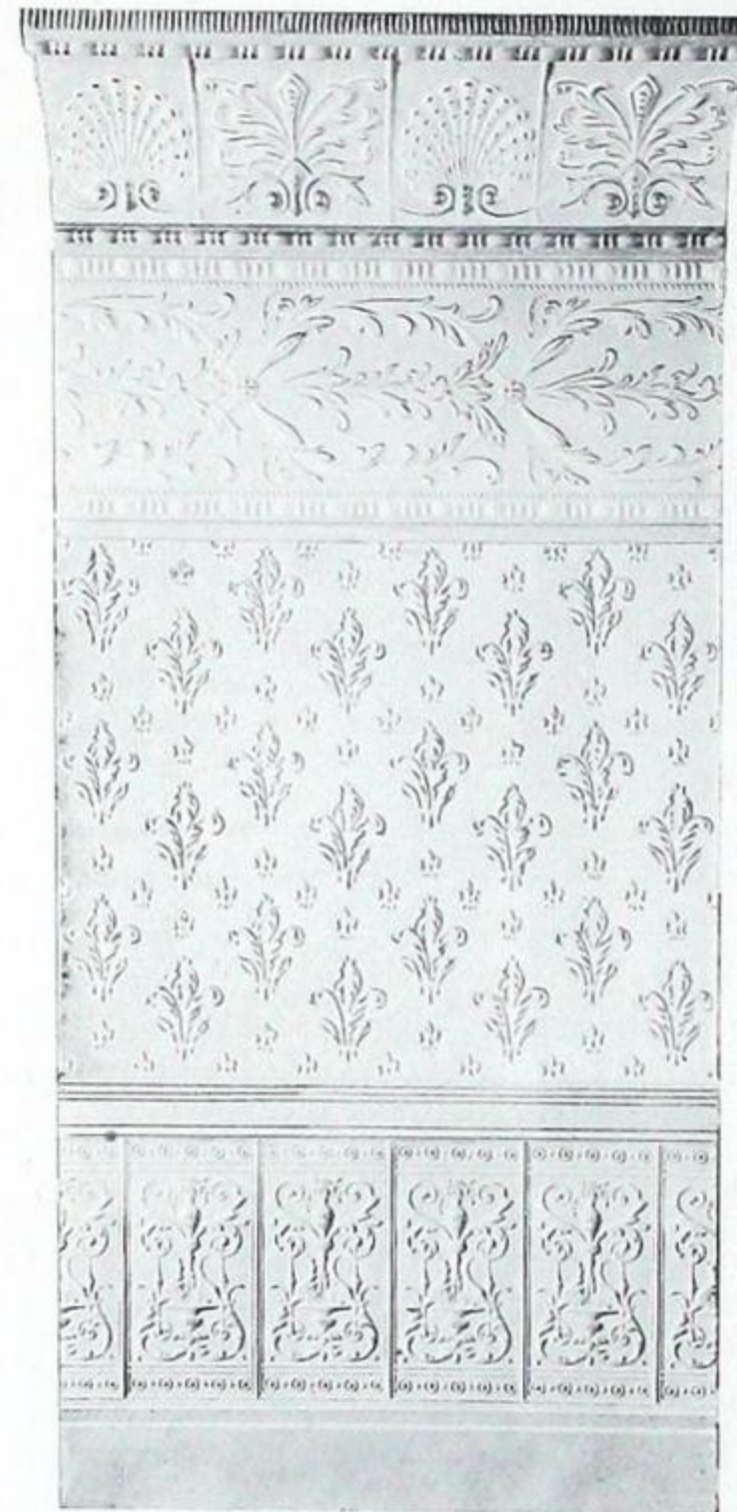

Fig. 3304.

Dado, Plates No. 457 ; Wall, Plates No. 418;
Frieze, " 804 ; Cove Cornice, " 303.

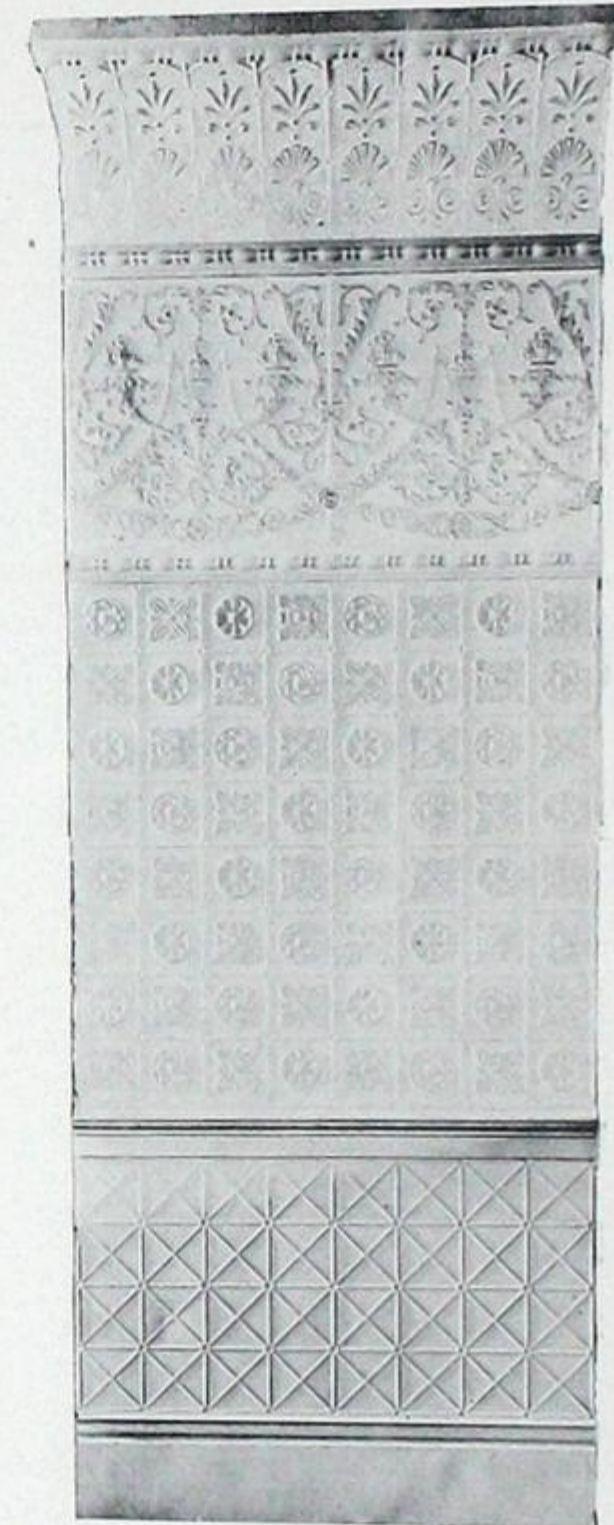

Fig. 3305.

Dado, Plates No. 435 ; Wall, Plates No. 437;
Frieze, " 806 ; Cove Cornice, " 301.

Wall Designs.

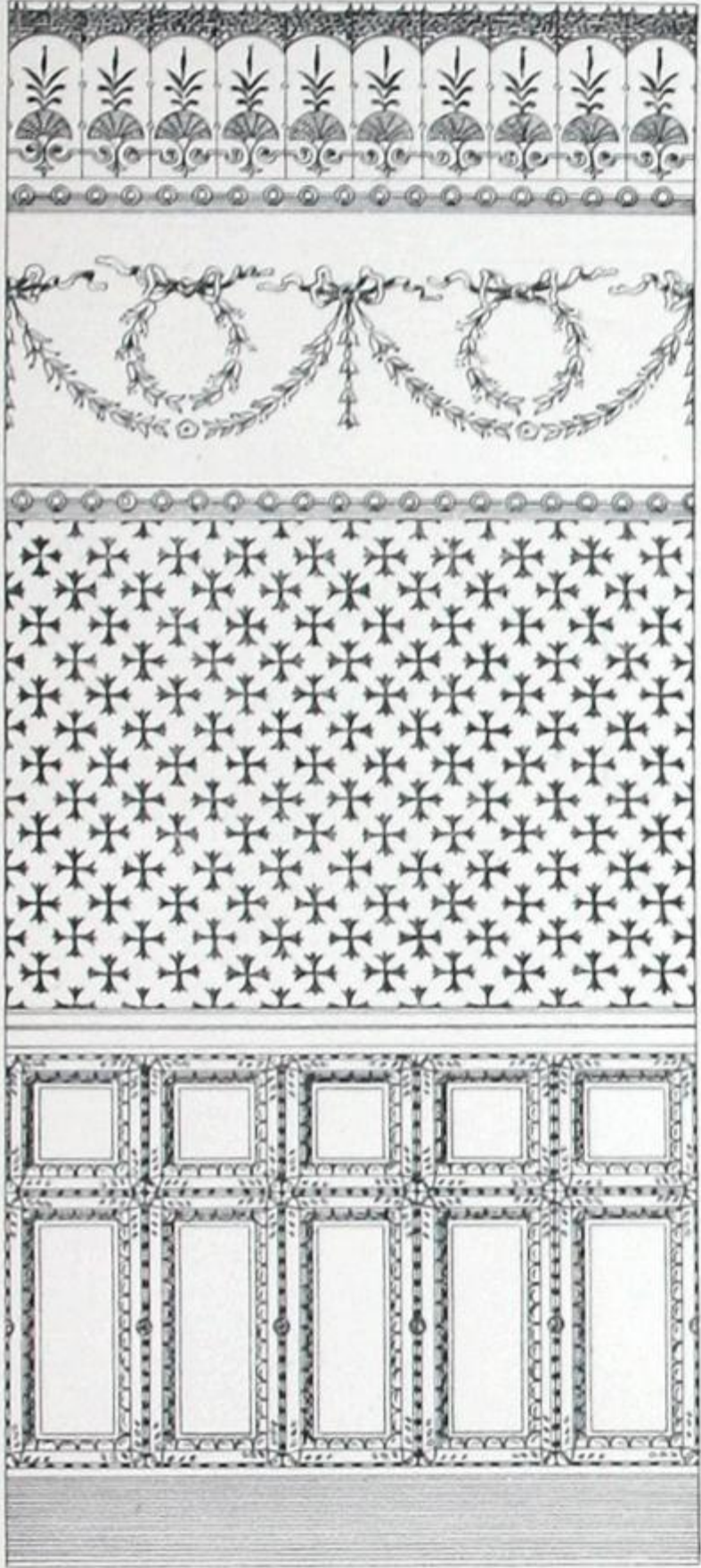

Fig. 3306.

Dado, Plates Nos. 402 and 403.
 Wall, - Diaper No. 812.
 Frieze, - - - No. 810.
 Cove, - - - - No. 301.

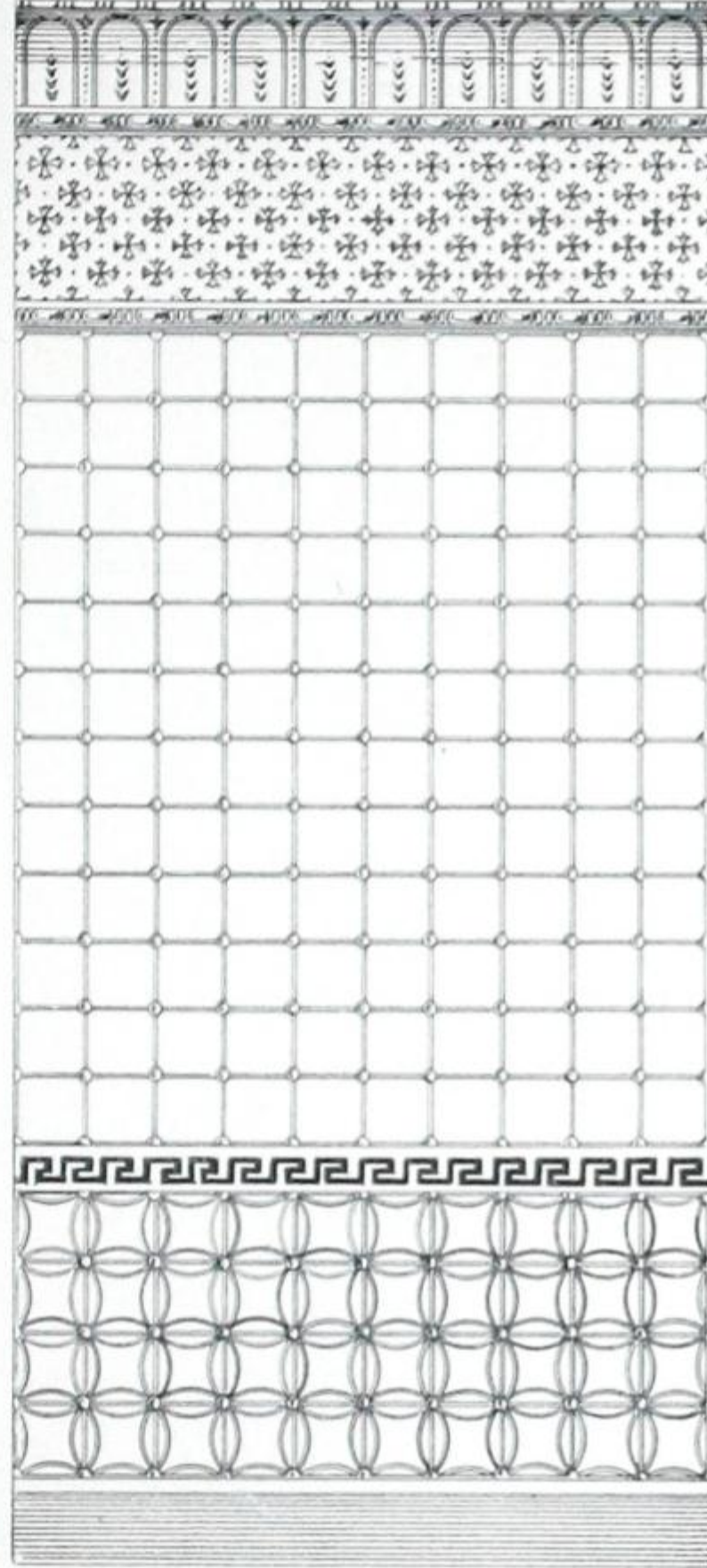

Fig. 3307.

Dado, - - - Plate No. 432.
 Wall, - - - - " 436.
 Frieze, - - - " 812.
 Cove, - - - - No. 300.



Fig. 3308.

Dado, Plates Nos. 456 and 459.
 Wall, - - - Plate No. 425.
 Frieze, - - - Nos. 807 and 808.
 Cove, - - - - No. 303.

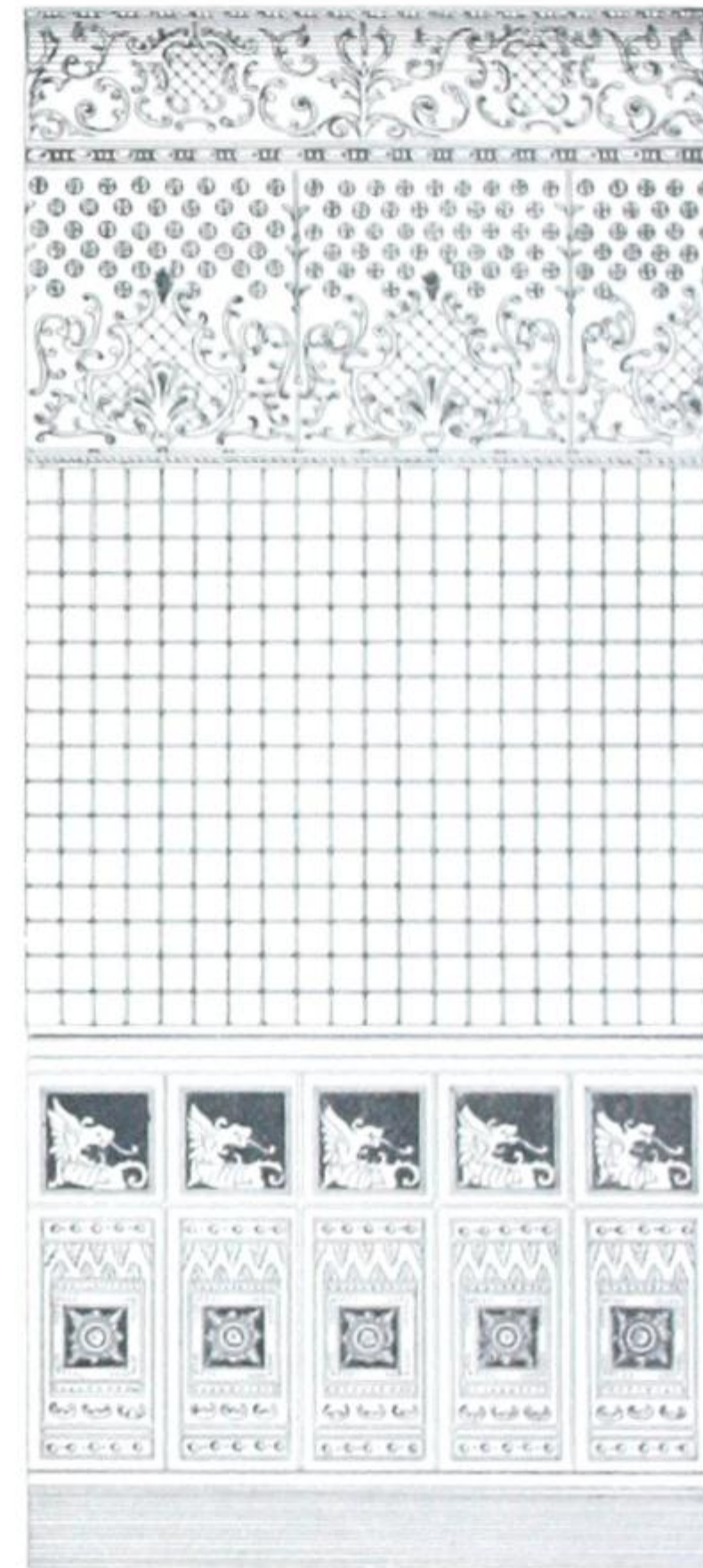

Fig. 3309.

Dado, Plates Nos. 454 and 458.
 Wall, - - - Plates No. 438.
 Frieze, - - - - " 815.
 Cove, - - - - No. 339.

Ceiling Designs.

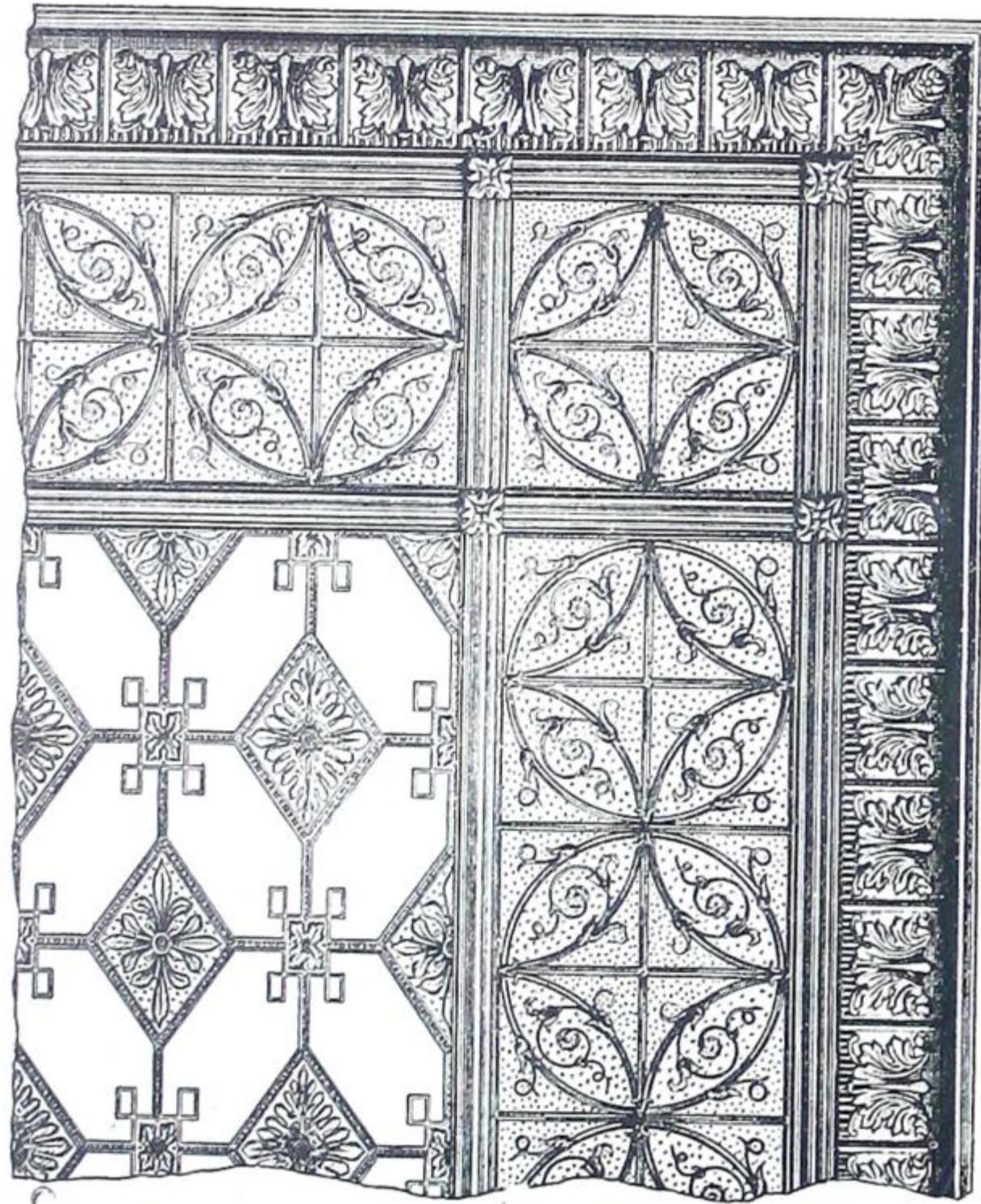

Fig. 3500.—Corner section, 5 x 6 feet.
Shows Plates No. 422, with a border of Plates No. 420,
Cove Cornice and Mouldings.

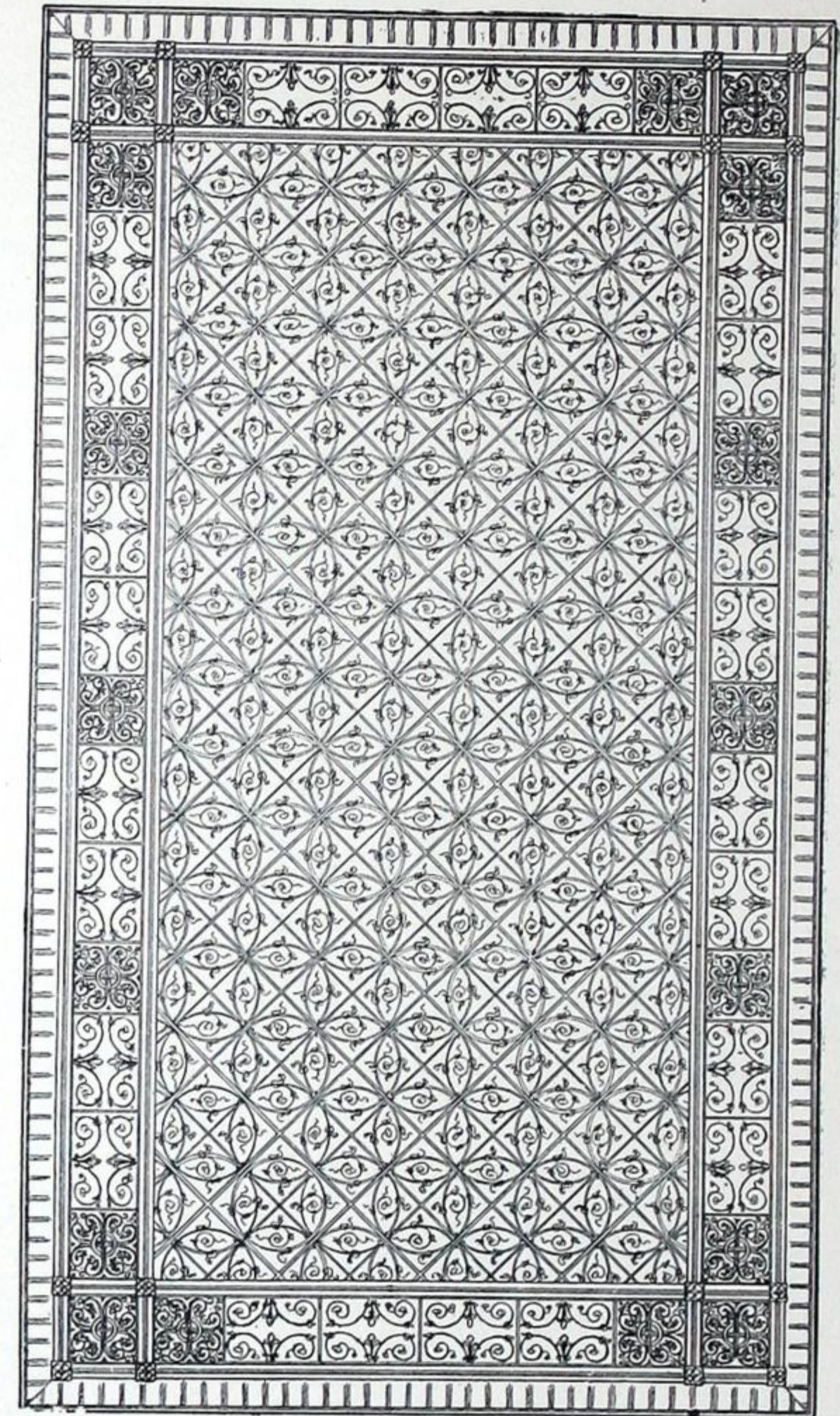

Fig. 3501.—Ceiling, 13 x 23 feet.
Shows ceiling of Plates No. 420, with border of Plates Nos. 421,
and 800, Mouldings No. 927, and Cove Cornice.

THE METALLIC ROOFING COMPANY OF CANADA, LIMITED, TORONTO, CANADA.

Ceiling Design.

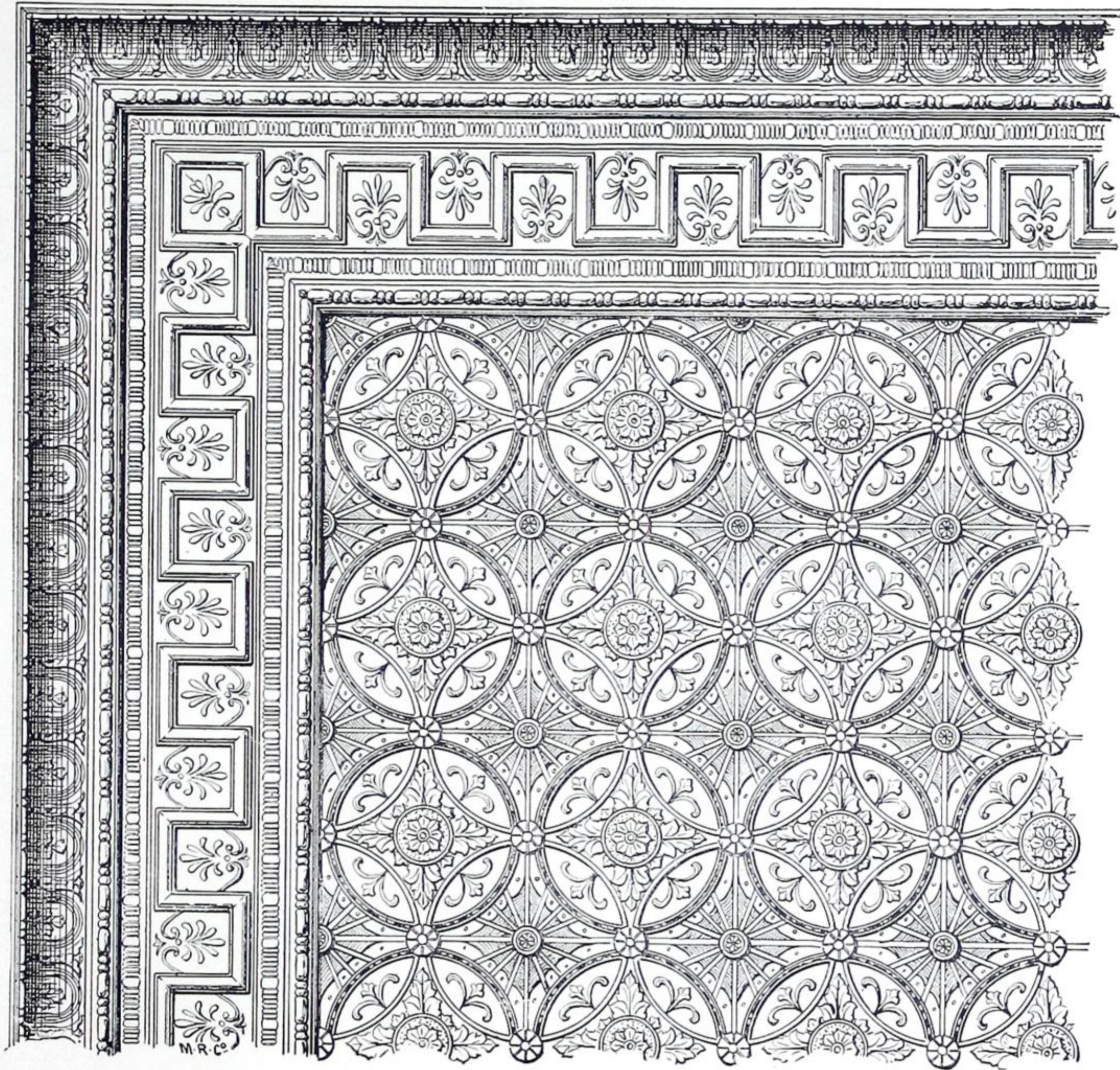

Fig. 3502.

Corner Section, 8 x 8 feet. Composed of Plates No. 427; Border No 802; Moulding No. 920, and Cove No. 302.



Ceiling Design.

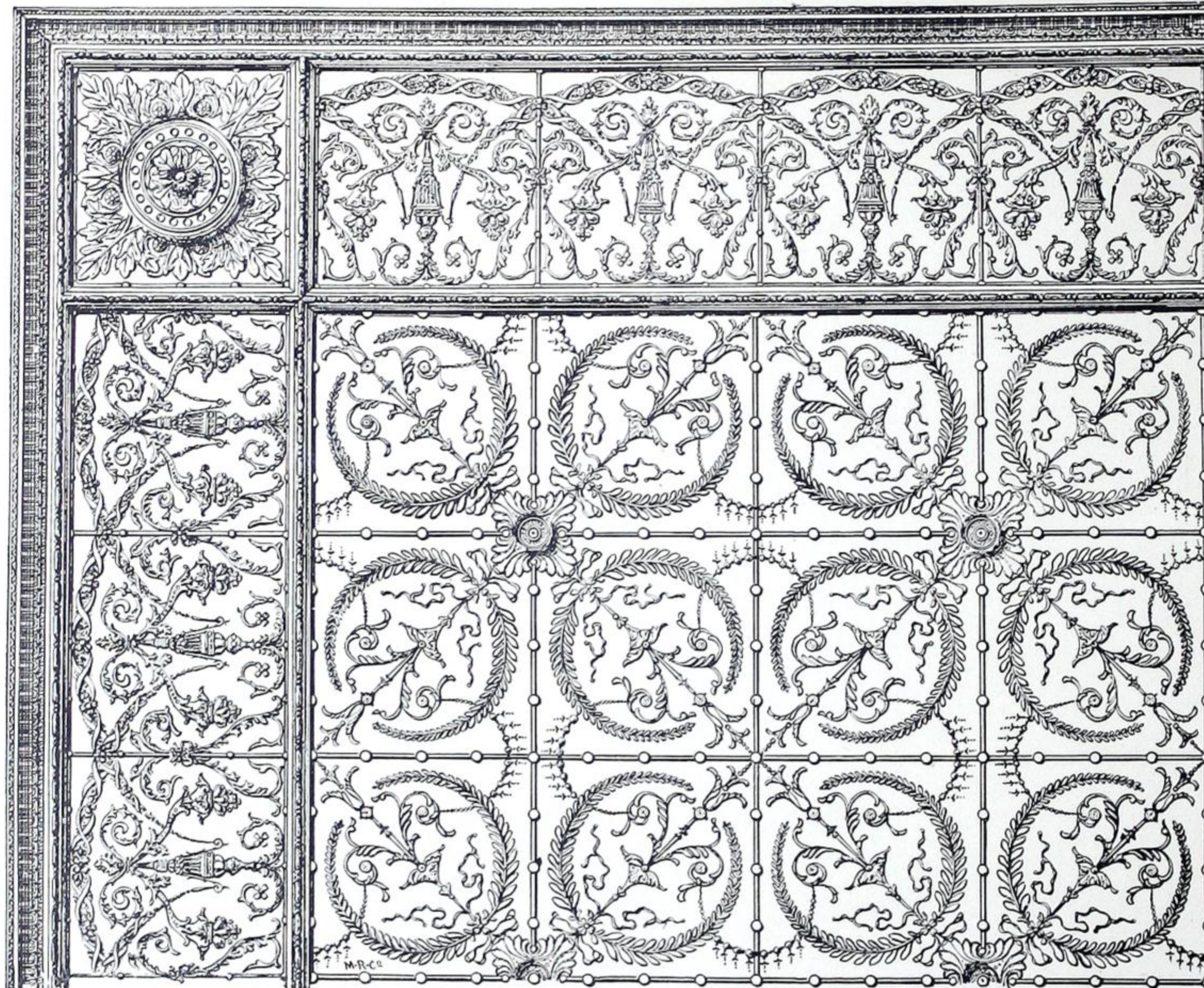

Fig. 3503.

Corner Section, 9 x 11 feet. Composed of Plates No. 439; Border No. 806, with Plate No. 431 for a corner; Moulding No. 920, and Cornice No. 304.

Ceiling Design.

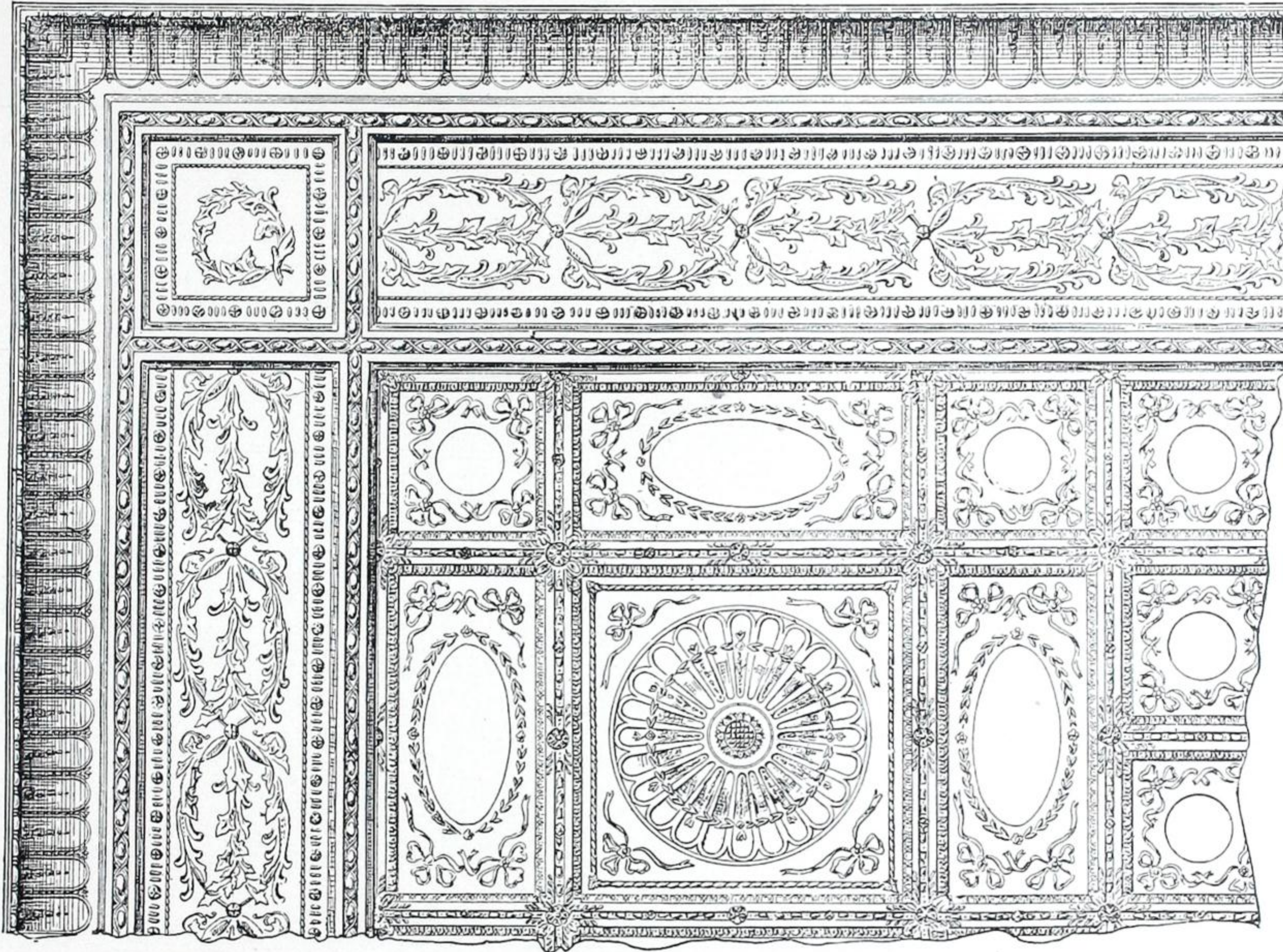

Fig. 3504.

Corner Section, 10 x 13 feet. Composed of "Empire" Plates Nos. 400 and 401, with Centrepiece No. 404; Border No. 804, and Cove Cornice No. 300.
A great number of different designs can be arranged with these plates to suit different sized rooms.

Ceiling Design.

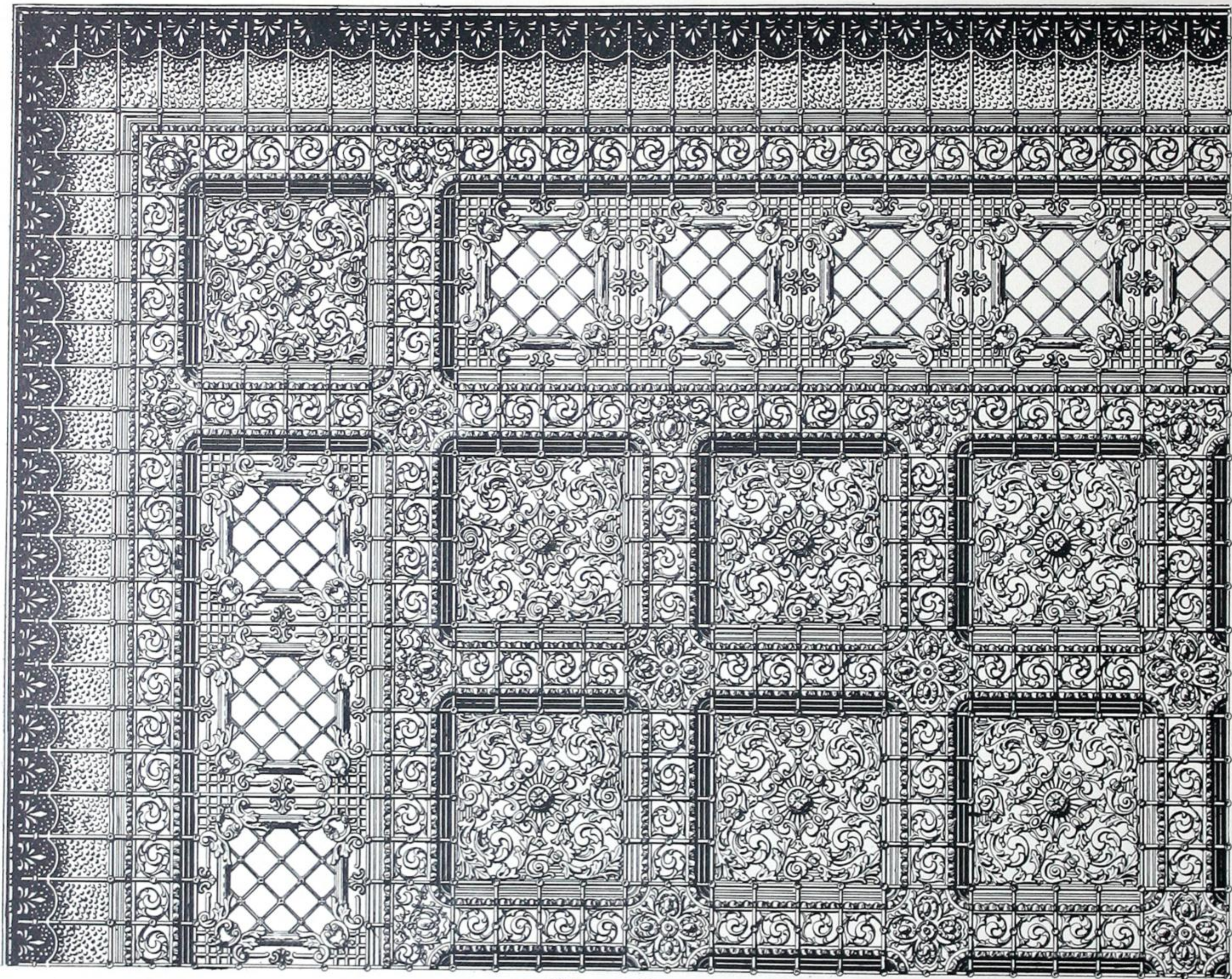

Fig. 3505.

Corner Section, 11 x 14 feet. Composed of Centres No. 706; Border Plates No. 444, and Cove Cornice No. 301.

Ceiling Design.

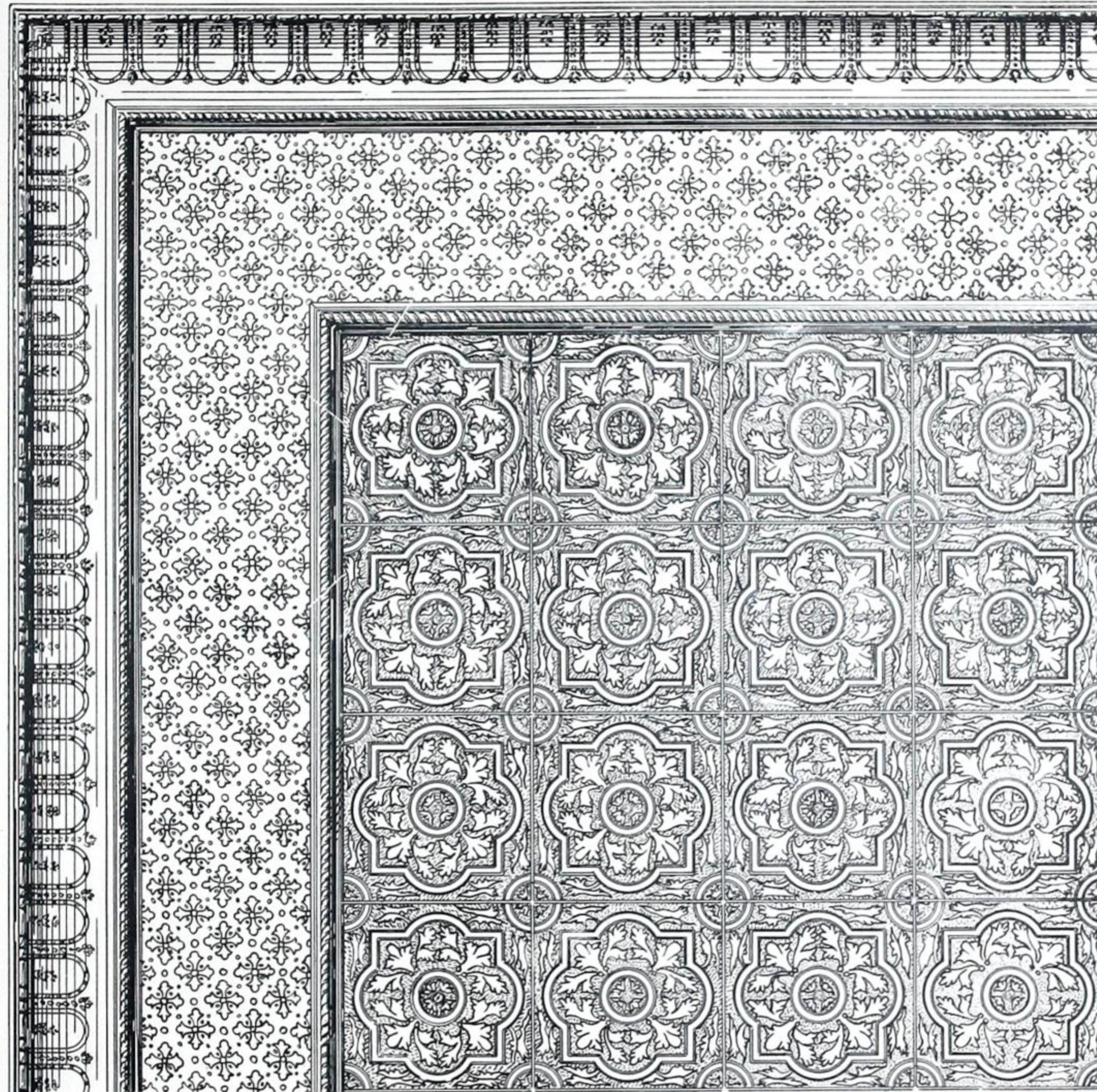

Fig. 3506.

Corner Section, 9 x 9 feet. Composed of Plates No. 429; Border No. 812; Mouldings No. 916, and Cornice No. 300.

Ceiling and Wall Design.

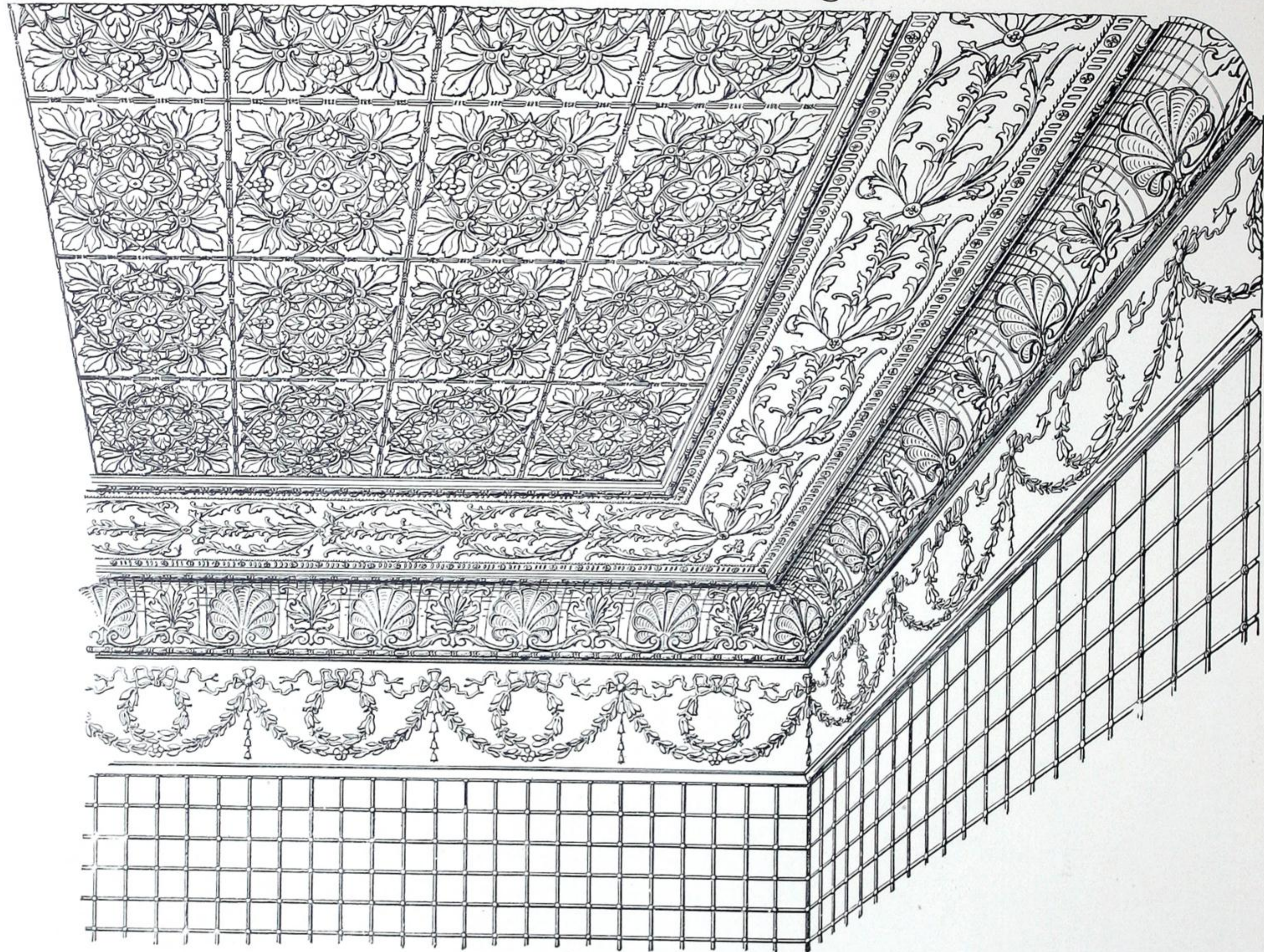

Fig. 3507.

Composed of Ceiling Plates No. 419; Border No. 804; Mouldings No. 920; Cove Cornice No. 303; Frieze No. 810, and Wall Plates No. 436.

Residence Design.

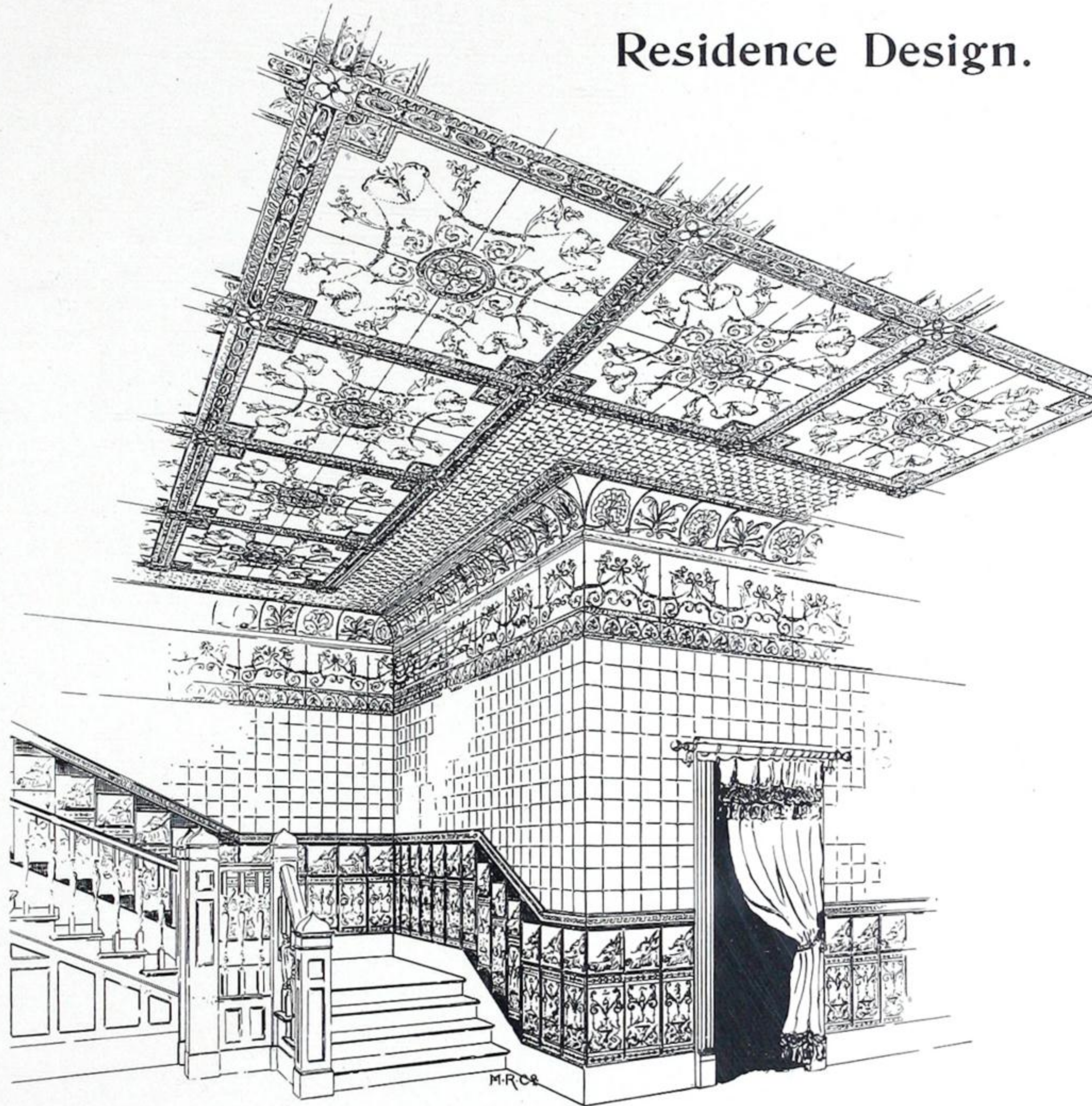

Fig. 3508.

Hall in residence, finished with embossed metal. Dado Nos. 455 and 457, Dado Capping No. 923; Wall Plates No. 436; Frieze No. 446; Cornice No. 303; Border No. 812; Mouldings No. 908, and Ceiling Plates No. 445.

THE METALLIC ROOFING COMPANY OF CANADA, LIMITED, TORONTO, CANADA.

Ceiling Design.

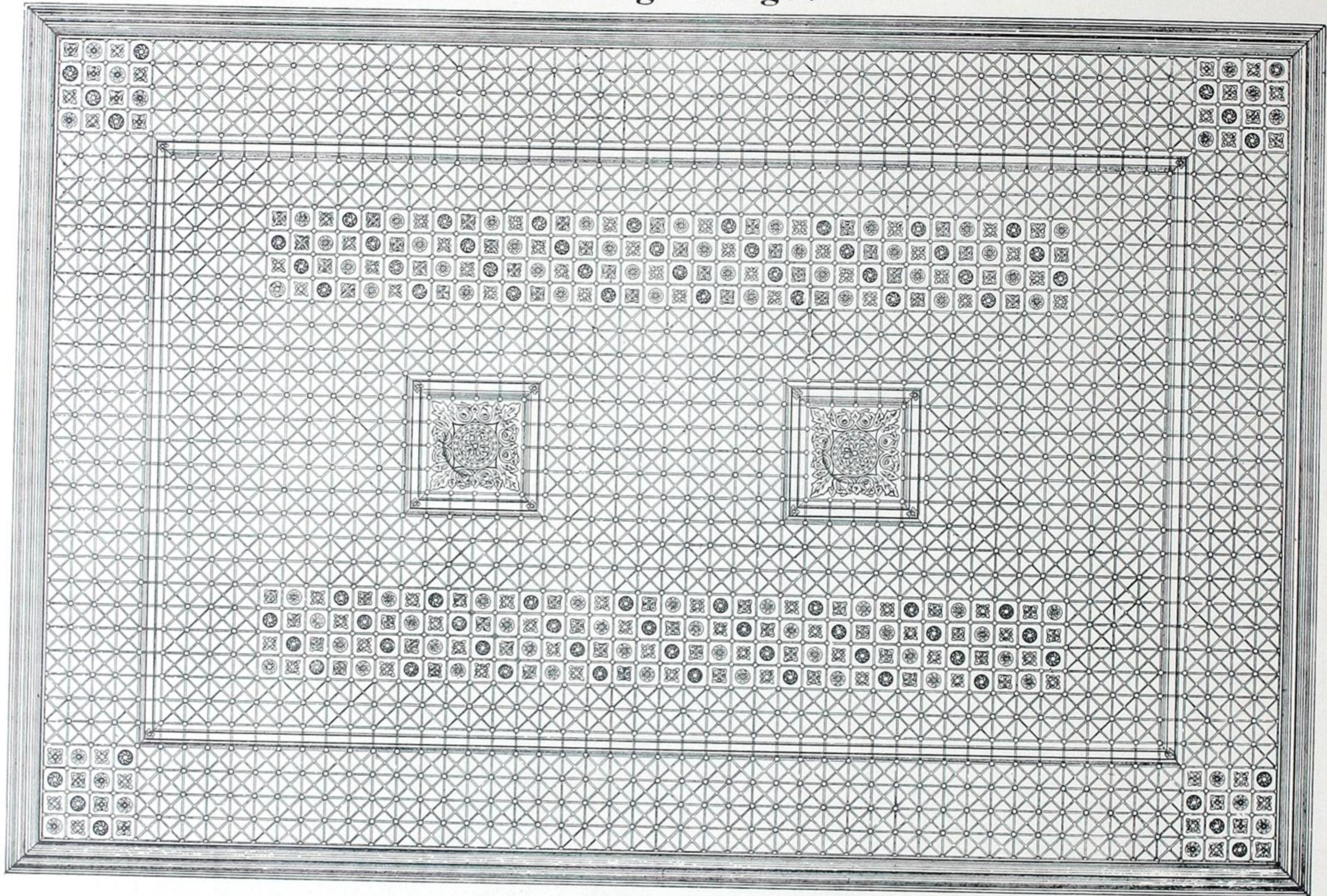

Fig. 3509.

Ceiling 18 x 29 feet. Composed of Plates Nos. 435 and 437; Centres No. 700; Moulding No. 908, and Plain Moulded Cornice.

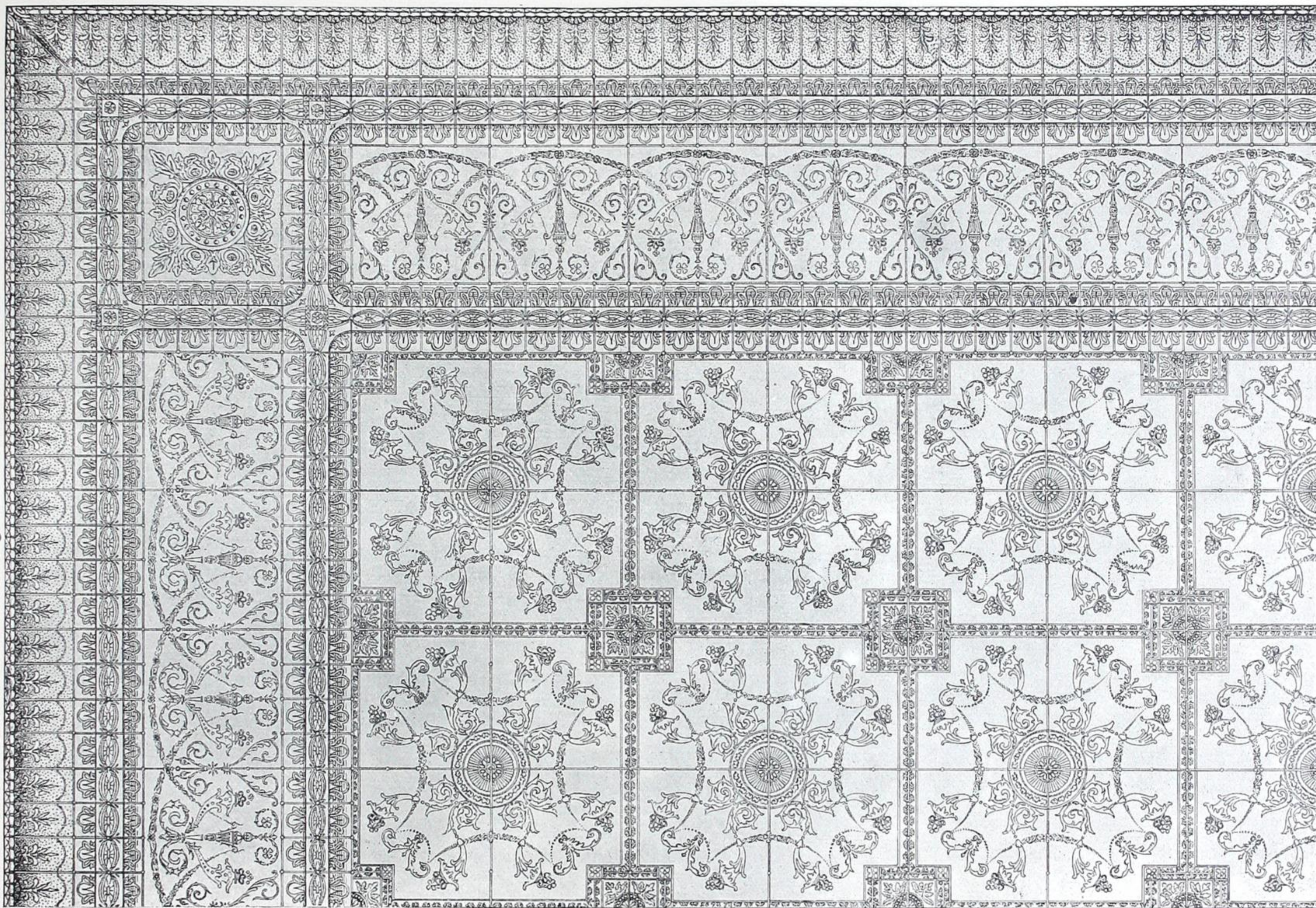

Fig. 3510.

Corner section 13 x 19 feet. Composed of Plates No. 445; Border No. 806; Centre No. 431, and Moulding No. 904; with Crosses, Tees and Ells to match, and Cove Cornice No. 301.

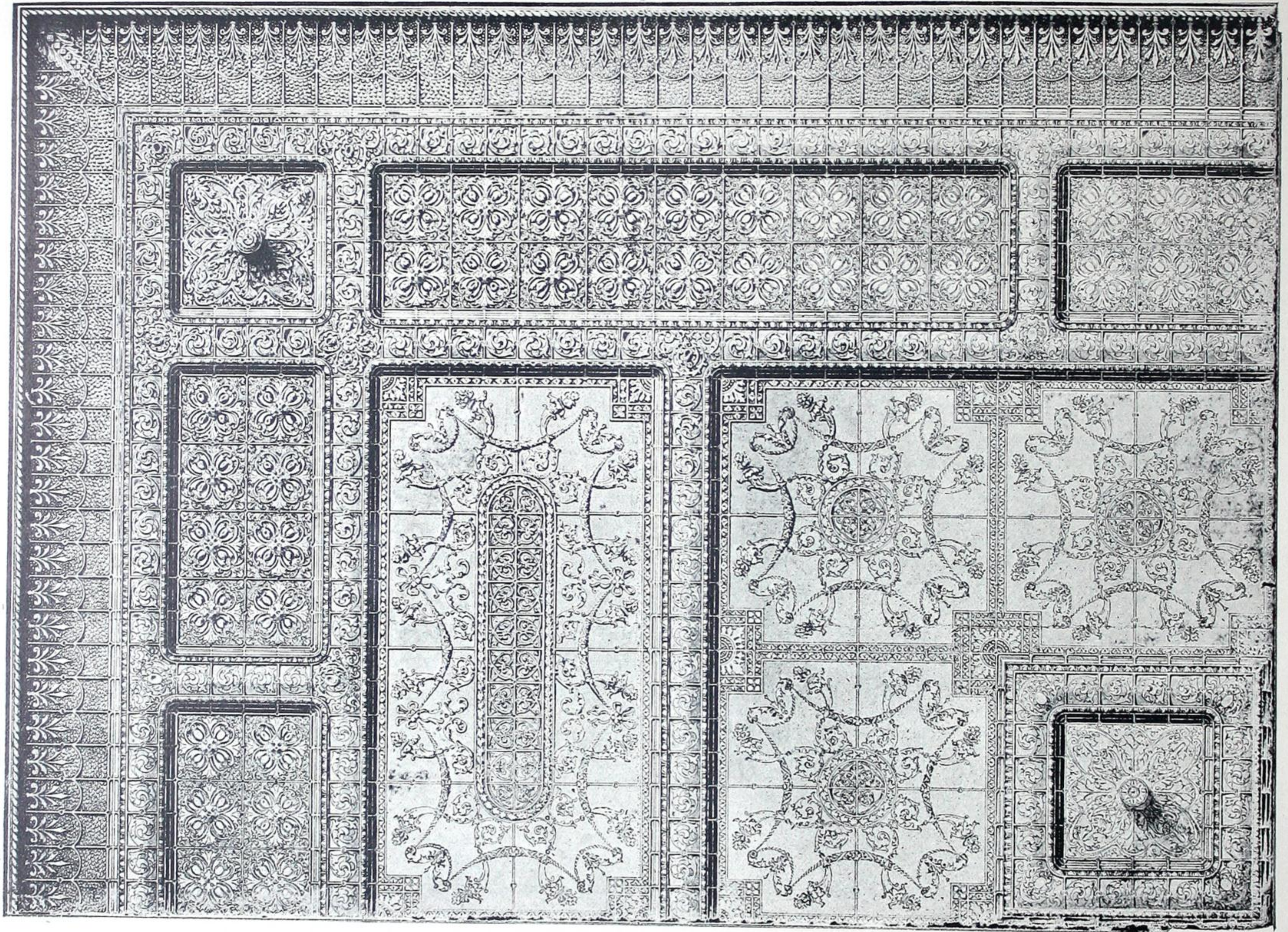
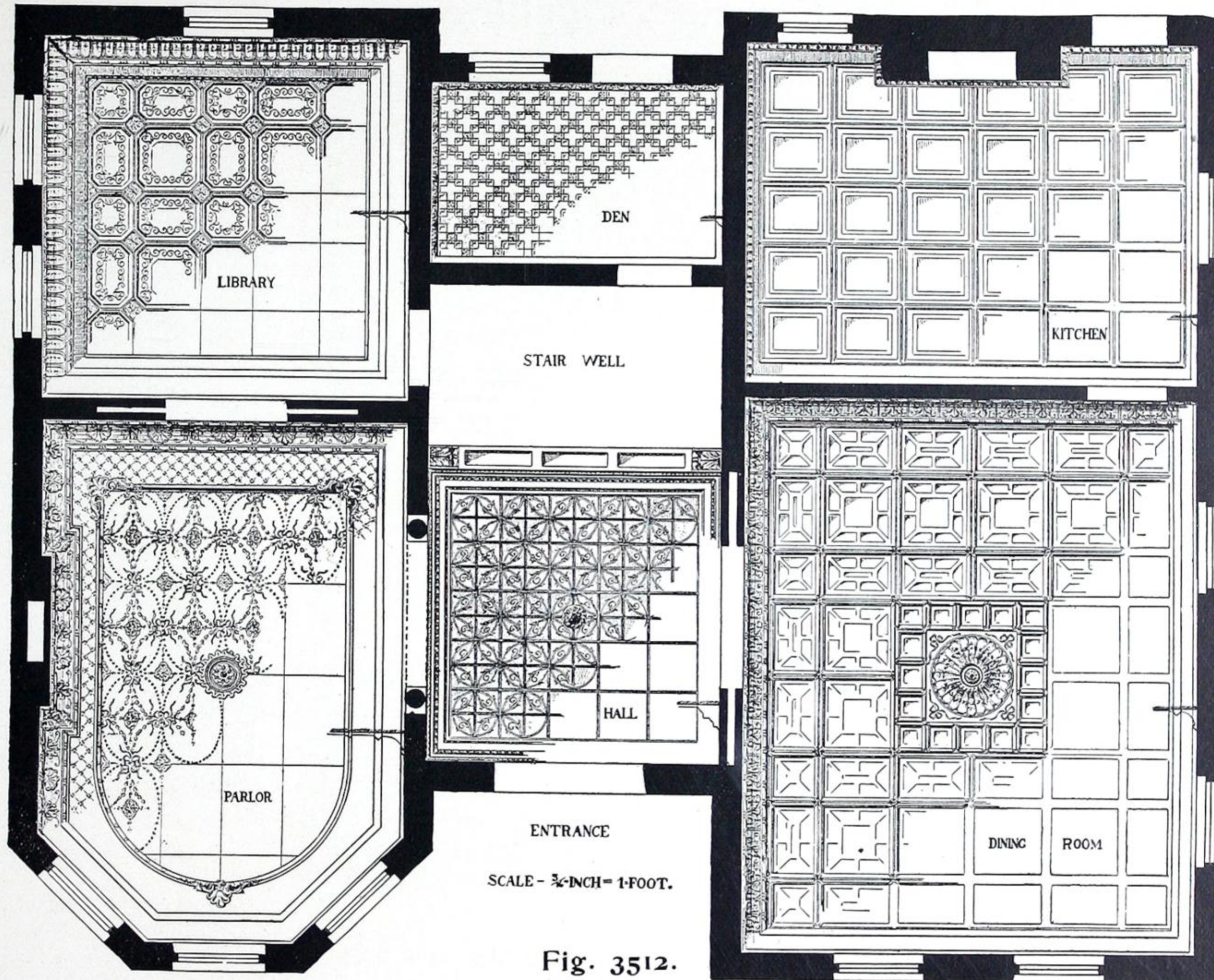

Fig. 3511.

Corner Section, 13 x 18 feet. Composed of Cove Cornice No. 301; Moulding No. 900; Field Plates Nos. 445 and 446, and Centre No. 706.

THE METALLIC ROOFING COMPANY OF CANADA, LIMITED, TORONTO, CANADA.



Showing our Metal Ceilings as applied to the rooms of a residence.

Corrugated Ceilings.

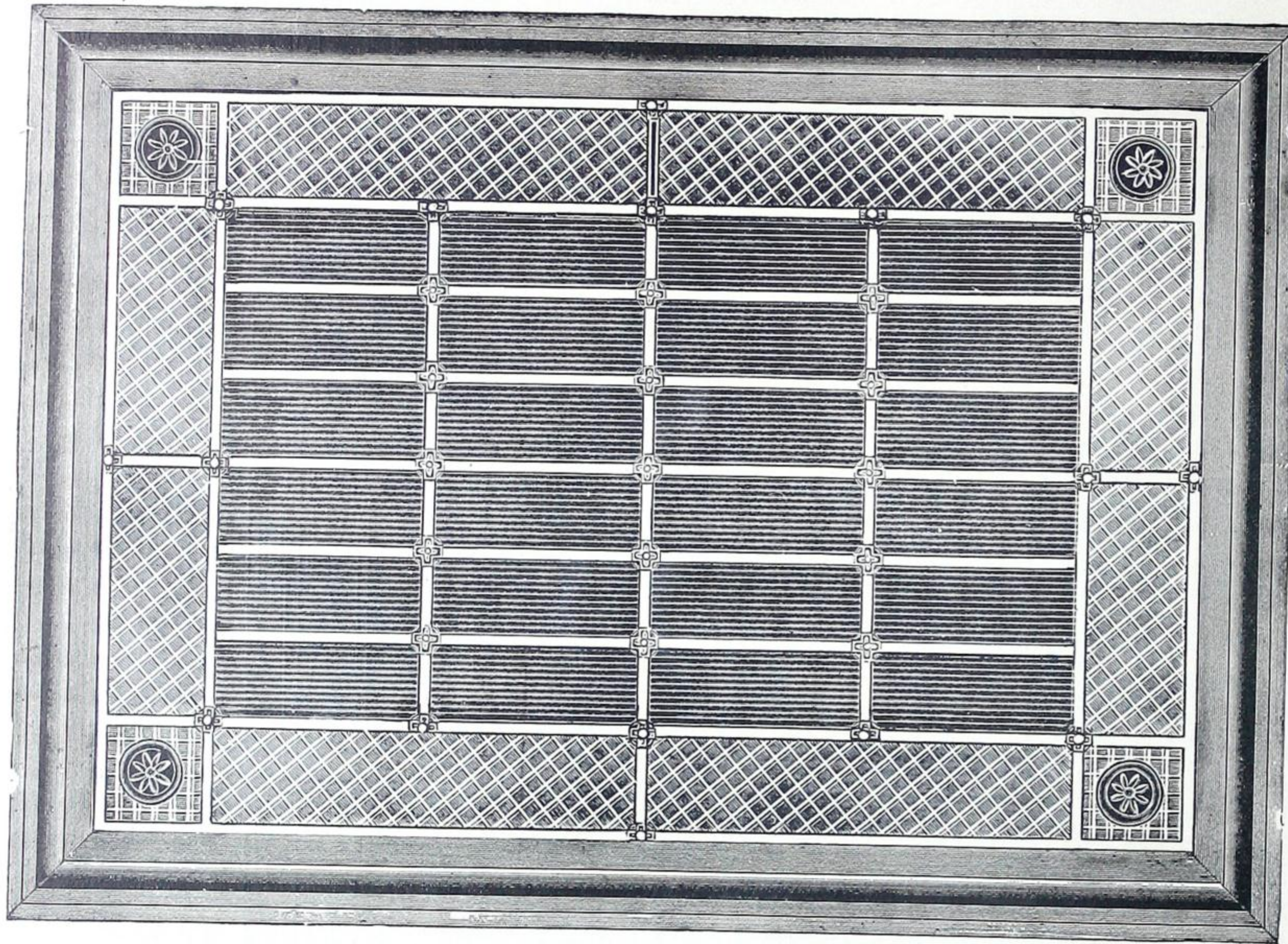

Fig. 3531.

Shows Ceiling 22 x 41 feet. Composed of our $\frac{1}{4}$ inch Corrugated Ceiling, divided into panels with suitable mouldings. The border may be of the same material, or of the crimped, twilled or any embossed design. The cornice may be of any of the designs shown in catalogue.

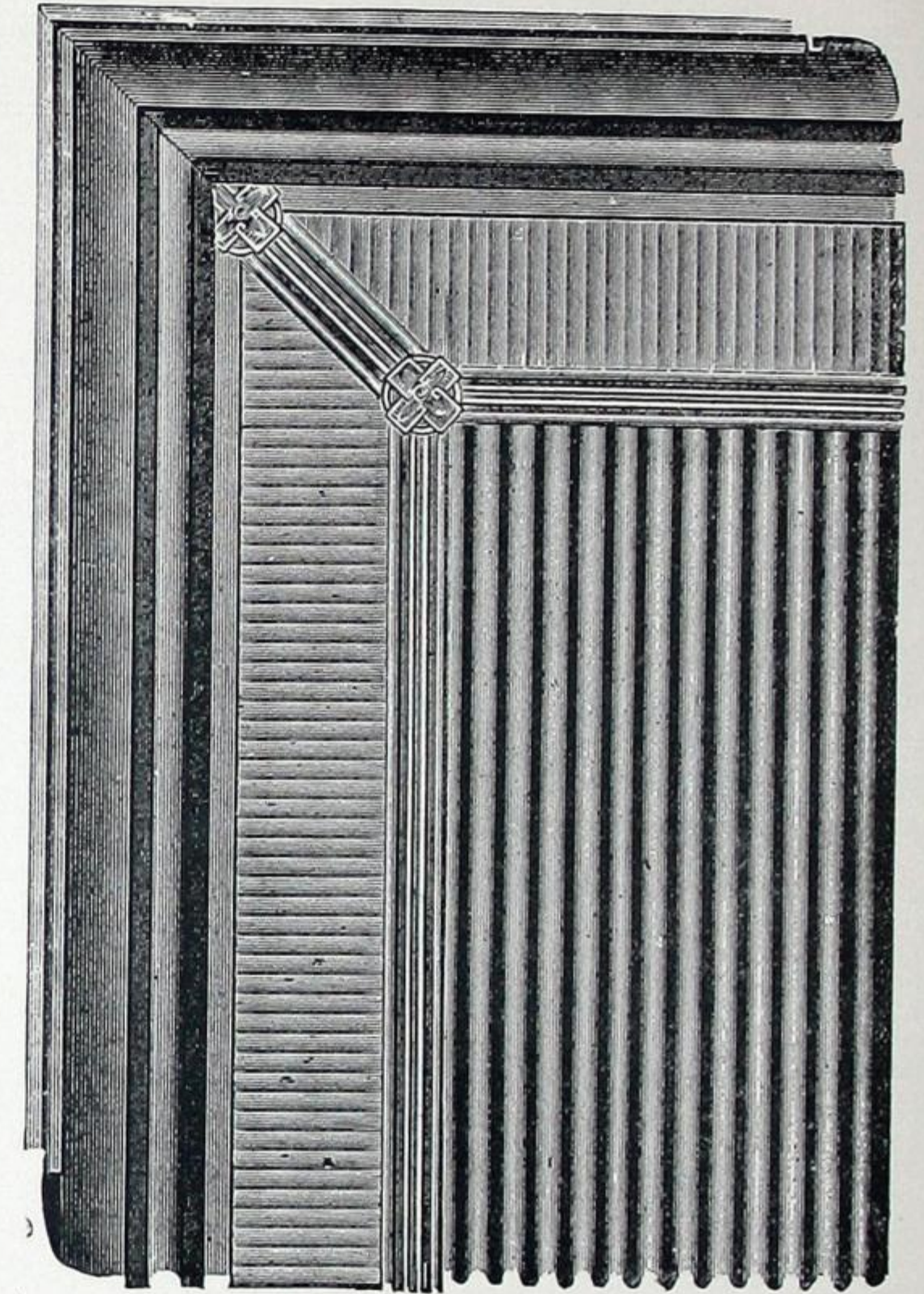

Fig. 3514.

Shows corner section of a Ceiling done with our 2-inch corrugated iron, a border of the same material, divided by a moulding, and a cornice, which may be of any of the designs shown.

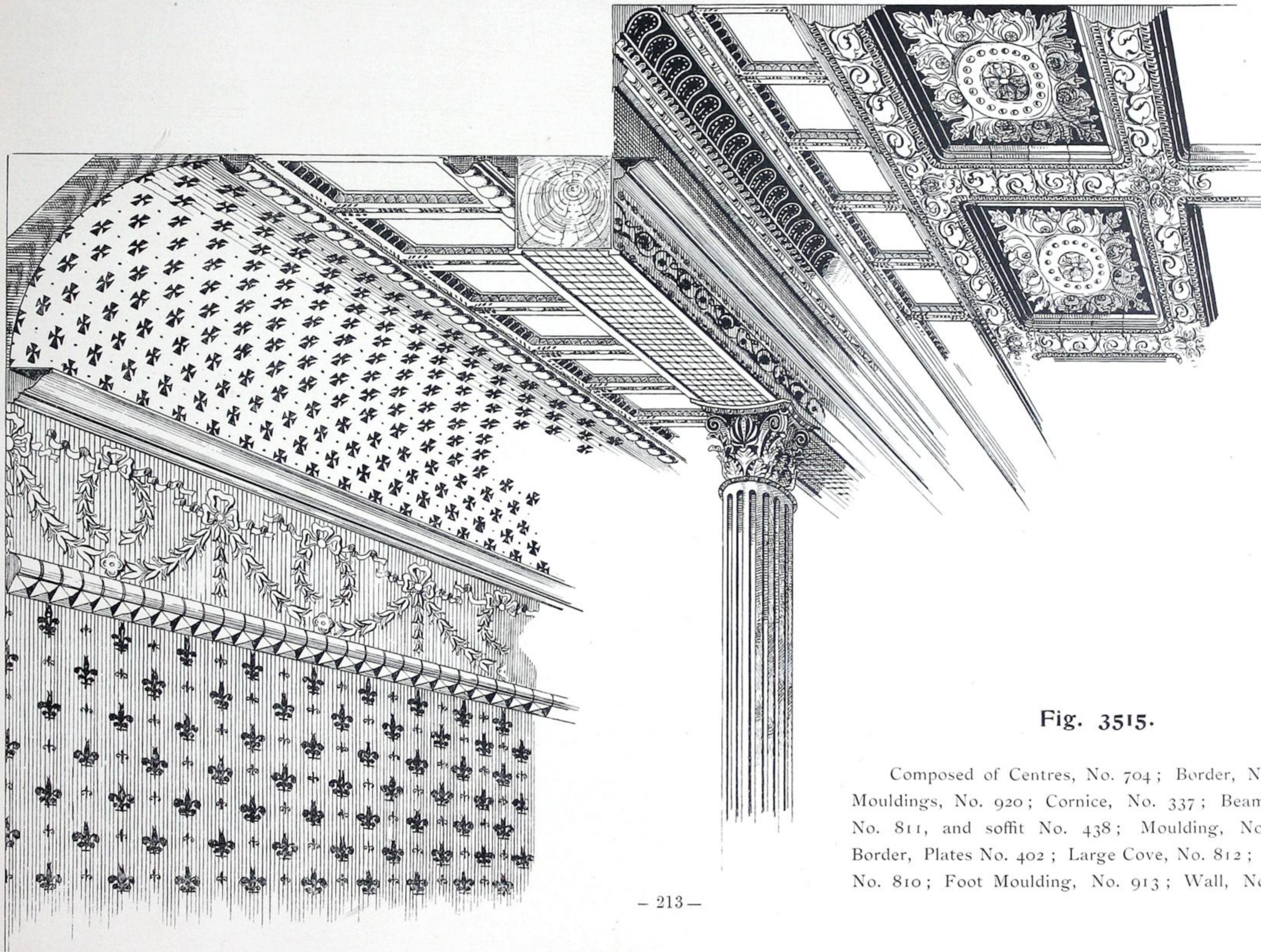

Fig. 3515.

Composed of Centres, No. 704; Border, No. 403; Mouldings, No. 920; Cornice, No. 337; Beam, sides No. 811, and soffit No. 438; Moulding, No. 916; Border, Plates No. 402; Large Cove, No. 812; Frieze, No. 810; Foot Moulding, No. 913; Wall, No. 418.

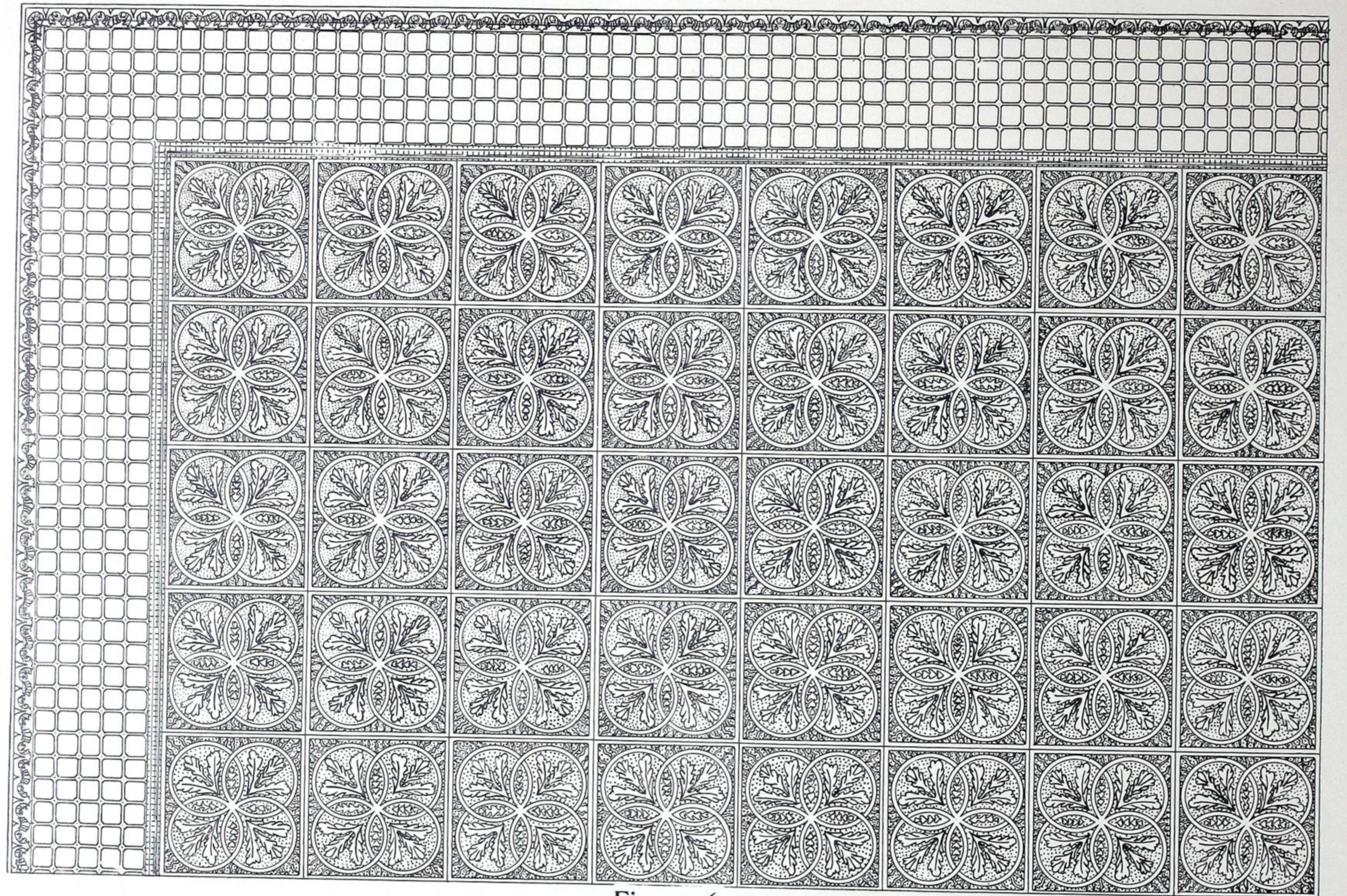

Fig. 3516.

Corner Section, 10 x 14 feet. Cornice No. 338; Border No. 438; Moulding No. 925; Plates No. 426.

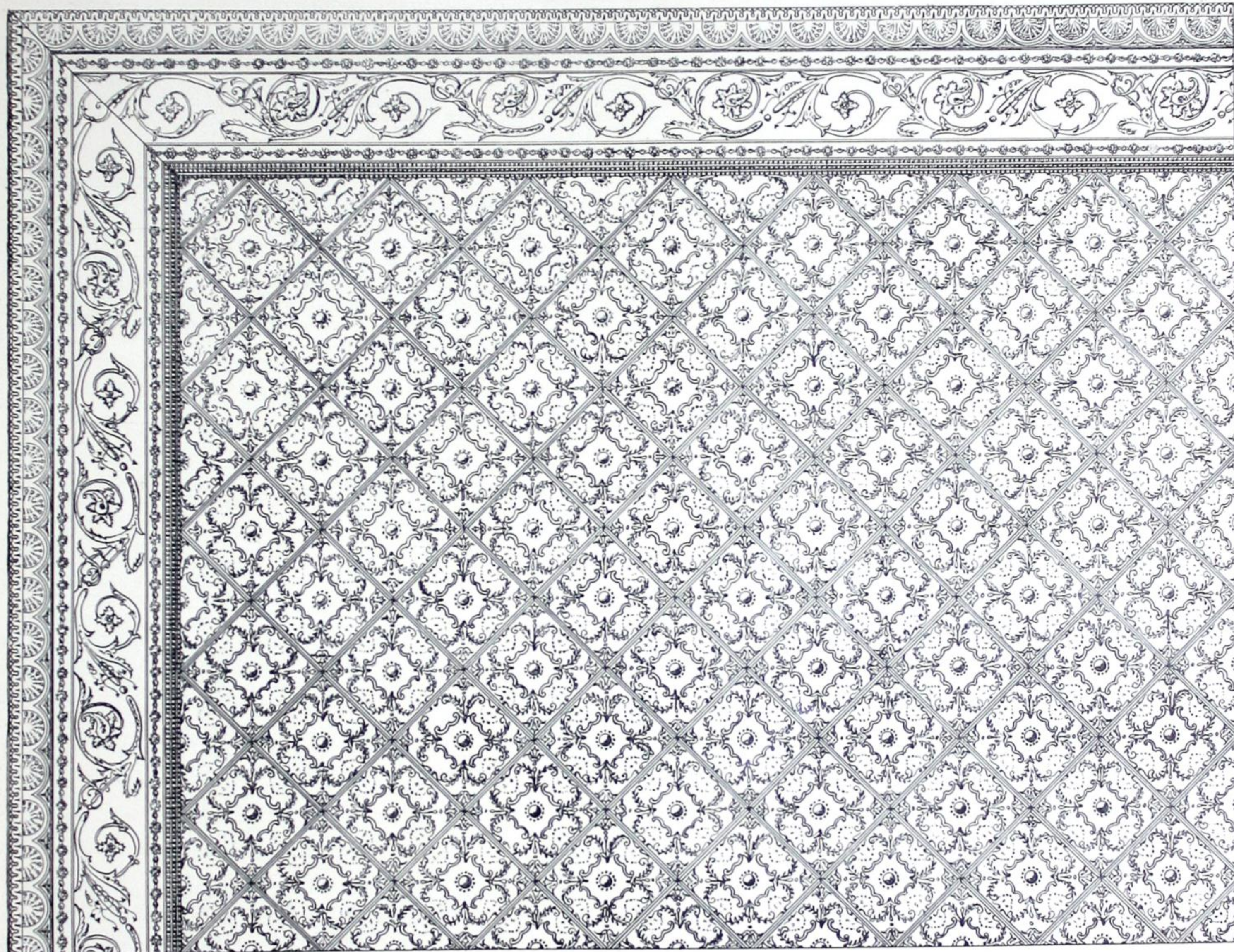

Fig. 3517.

Corner Section, 11 x 14 feet. Cornice No. 337; Border No. 811; Moulding No. 925; Plates No. 421.

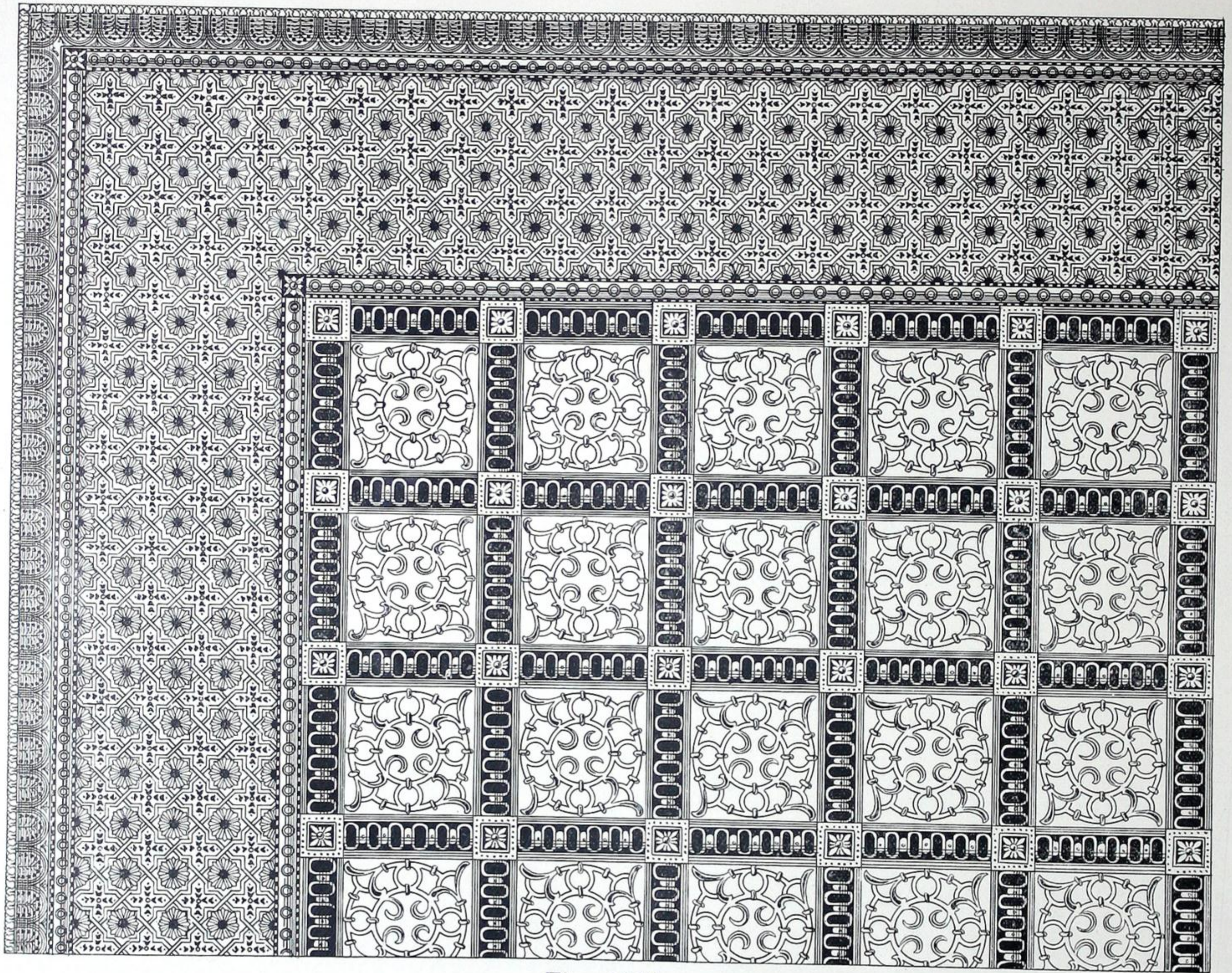

Fig. 3518.

Corner Section, 11 x 13½ feet. Cornice No. 337; Border No. 814; Moulding No. 924; Plates No. 476.

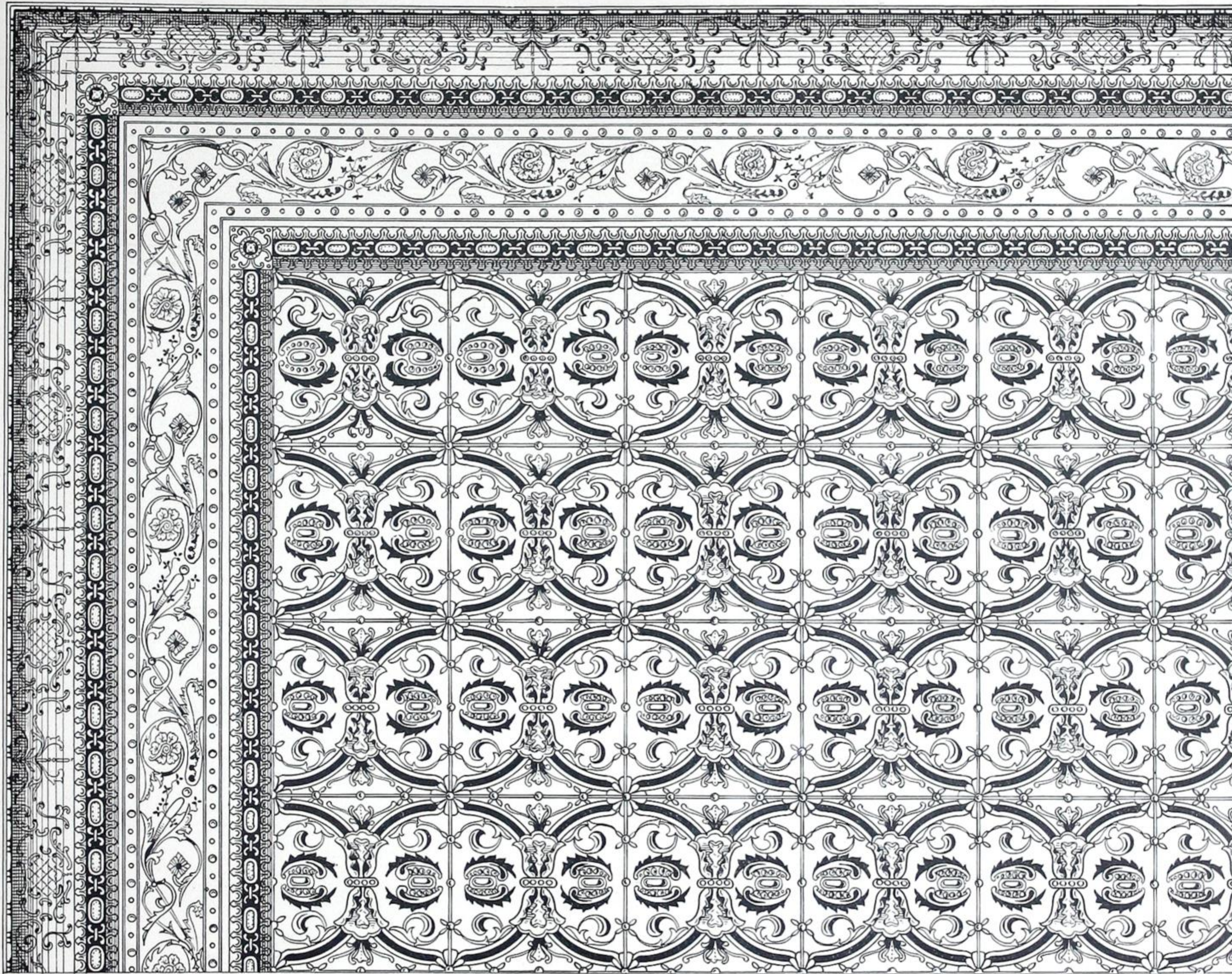

Fig. 3519.

Corner Section, 11 x 14 feet. Cove Cornice, No. 339; Mouldings No. 908; Border No. 811; Plate No. 477

Ceiling Design.

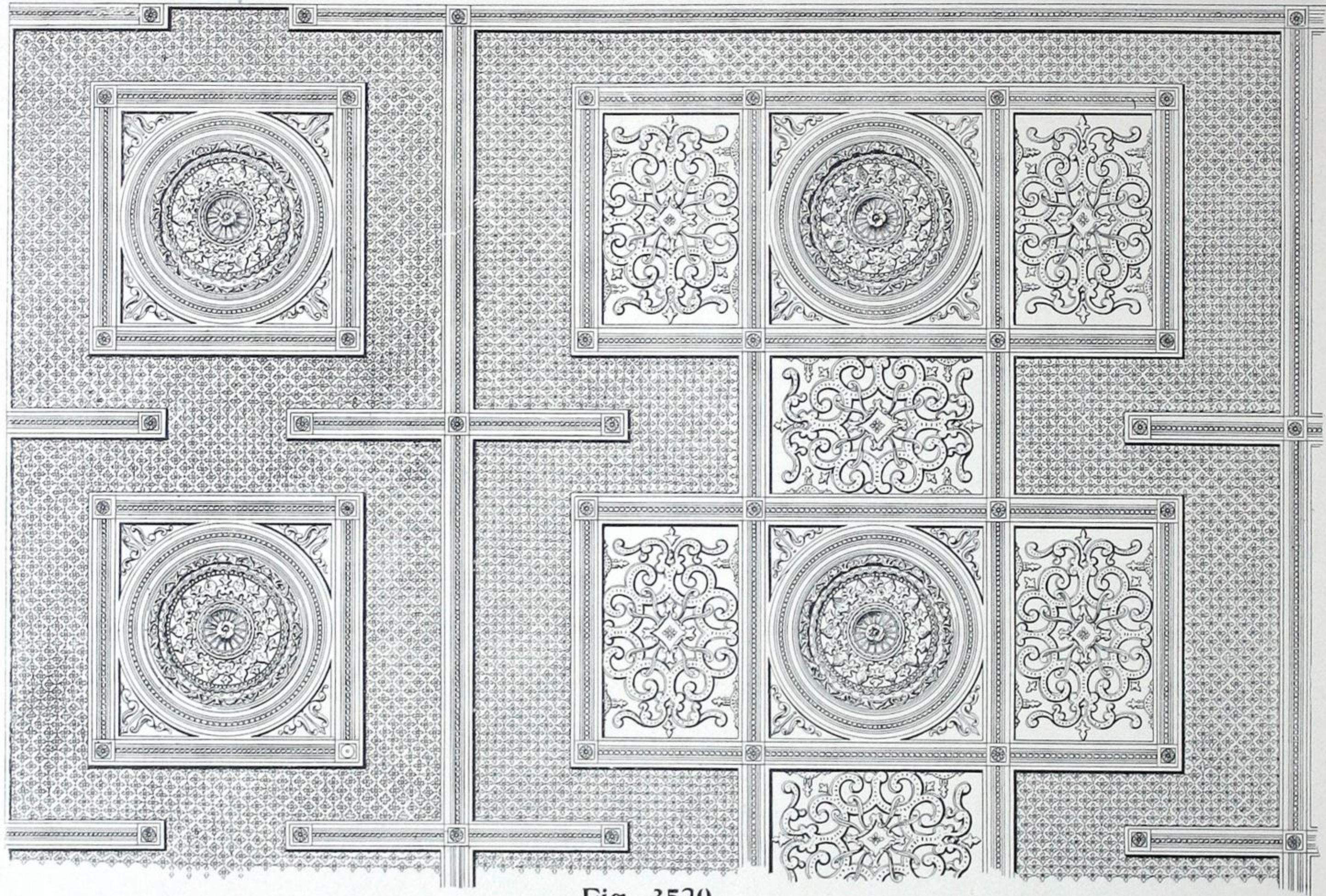

Fig. 3520.

Corner section showing space 25 x 38 feet of main ceiling in Chapel of Jesus and Mary Convent at Syllerie, Quebec. Composed of Centres, 55 inches in diameter, as No. 709 (not ventilating); Panels, 4 feet by 6 feet 2 inches, of Plates 417, 488, and 489, in combination as shown in Fig. 3105, page 194; Special Beams, 8 inches wide and 5 inches deep with 1½-inch balls planted on soffit around both the Centres and Panels, also dividing Ceiling into bays as shown; Special Spandrel Ornaments; Filler, No. 812 Diaper.

Ceiling Designs.

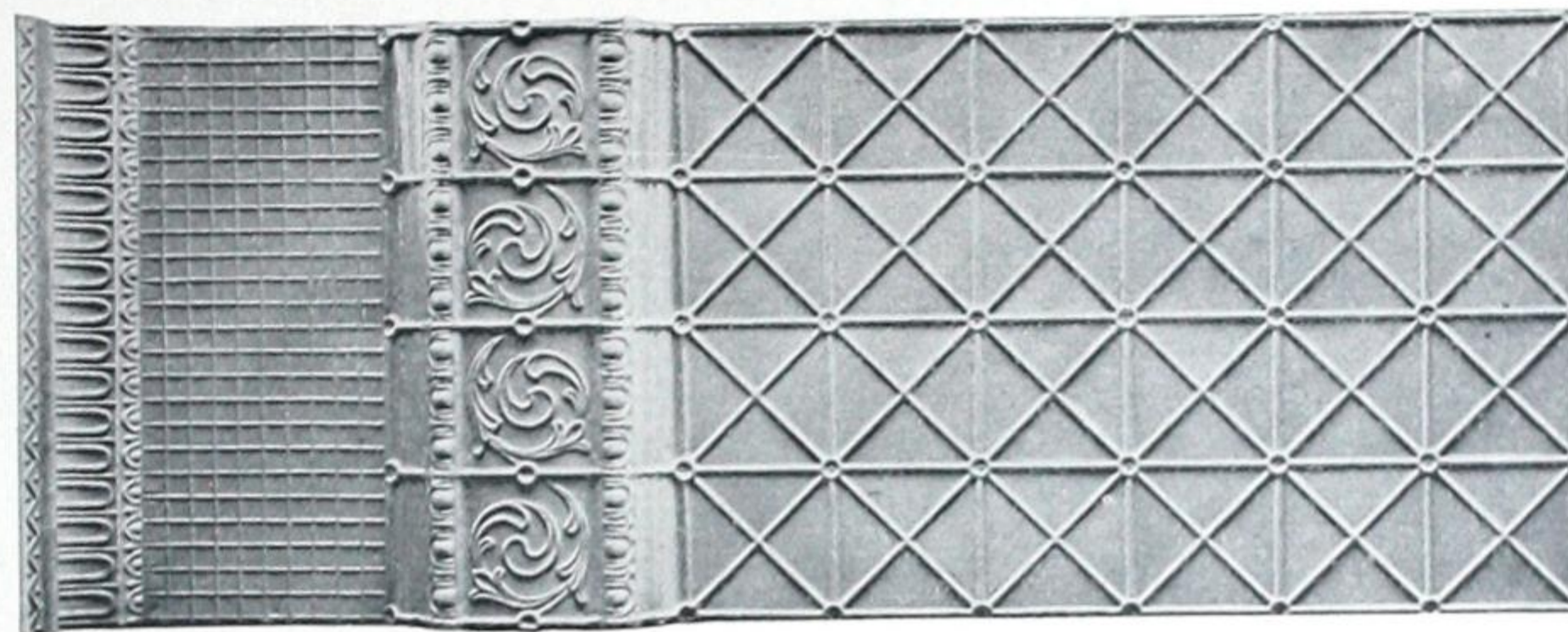

Fig. 3600.

Plates No. 435; Moulding No. 900; Cornice No. 304.

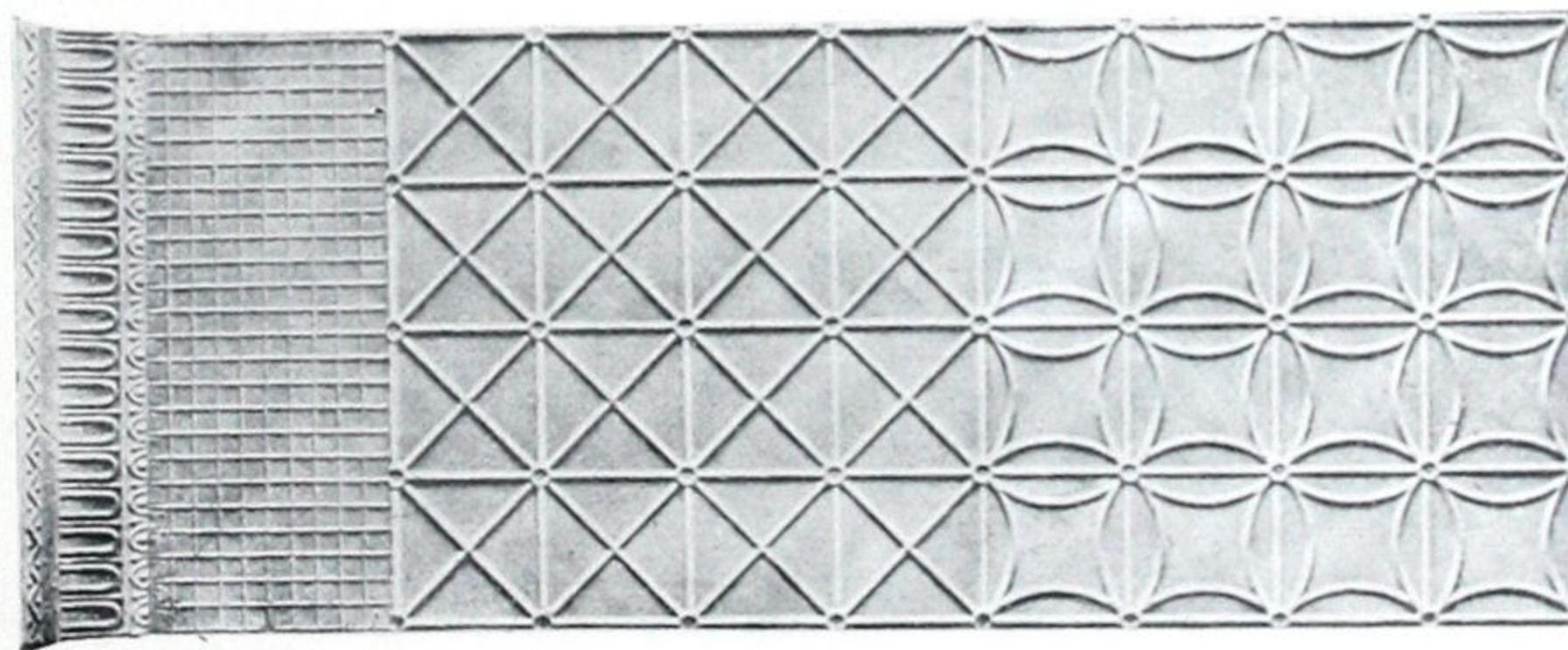

Fig. 3601.

Plates No. 435 in Border; Plates No. 432 in Field; Cornice No. 304.

THE METALLIC ROOFING COMPANY OF CANADA, LIMITED, TORONTO, CANADA.

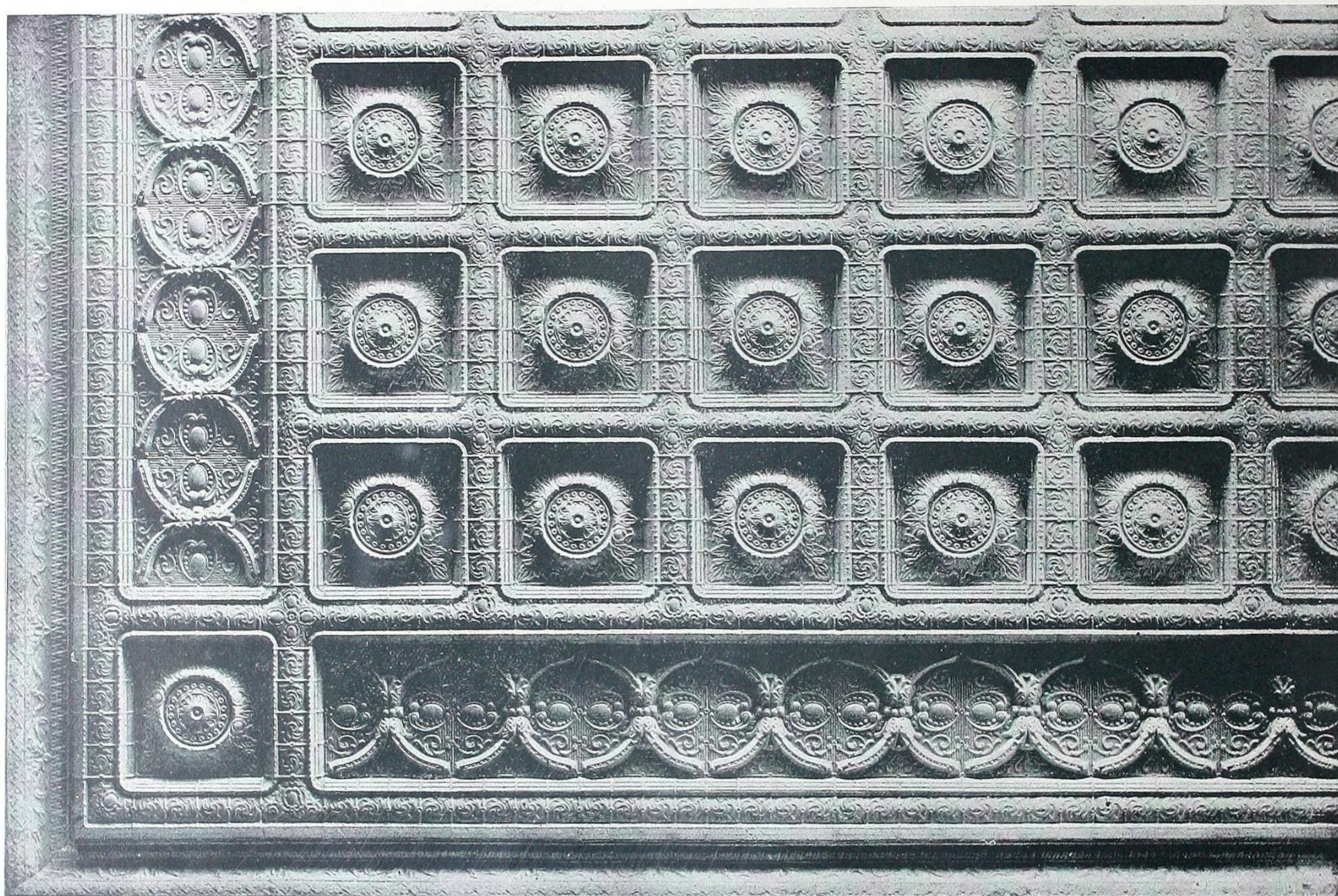

Fig. 3602.

Corner Section, 13 feet 9 inches x 20 feet 9 inches. Composed of Cornice No. 339; Moulding No. 900; Border No. 477; Corner Plate No. 704, and field of Centre Plates No. 704.

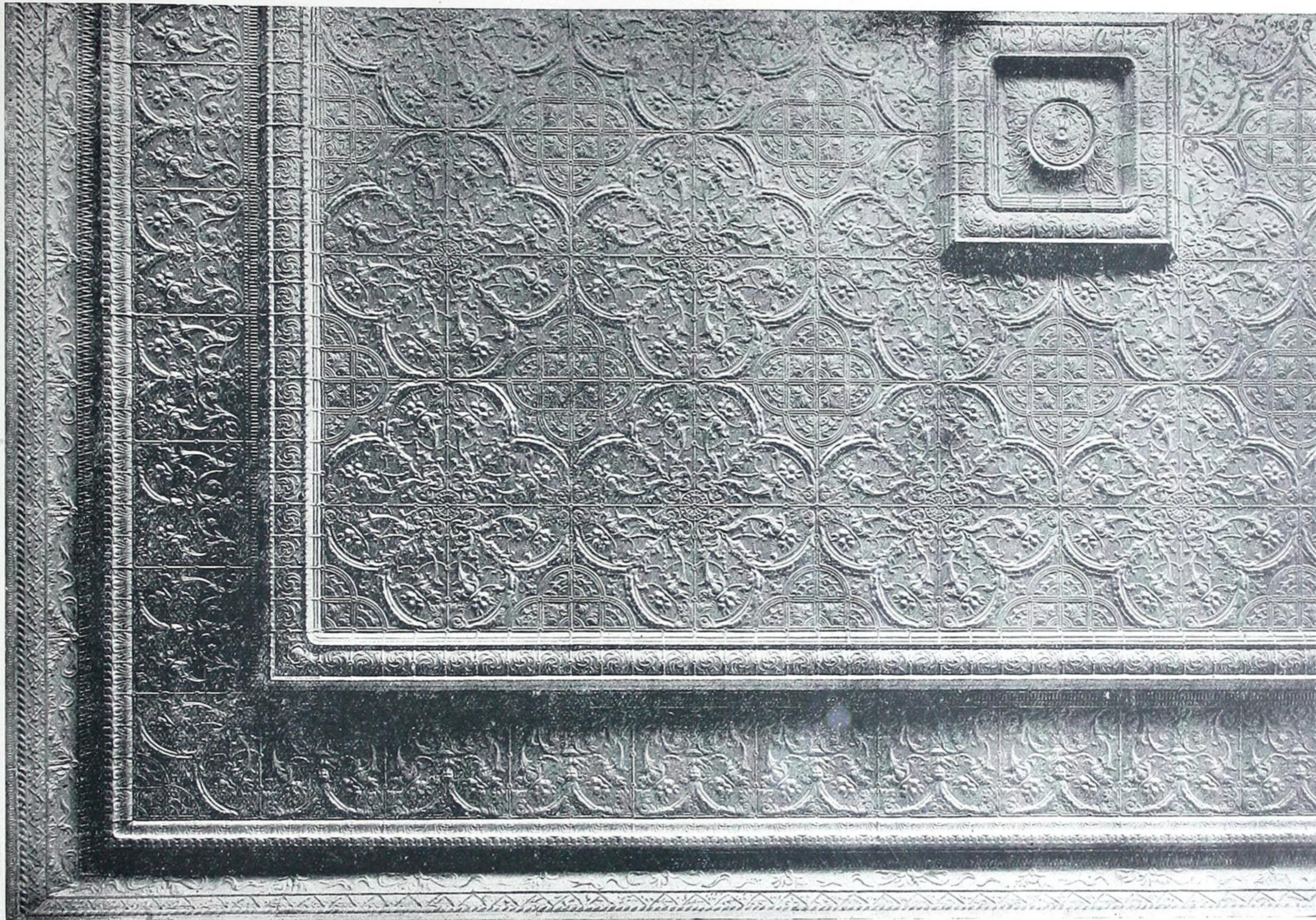

Fig. 3603.

Corner Section 14 x 21 feet. Composed of Cornice No. 339; Moulding No. 910; Border No. 442; Moulding No. 900; Field Plates No. 441; and Centre No. 704.

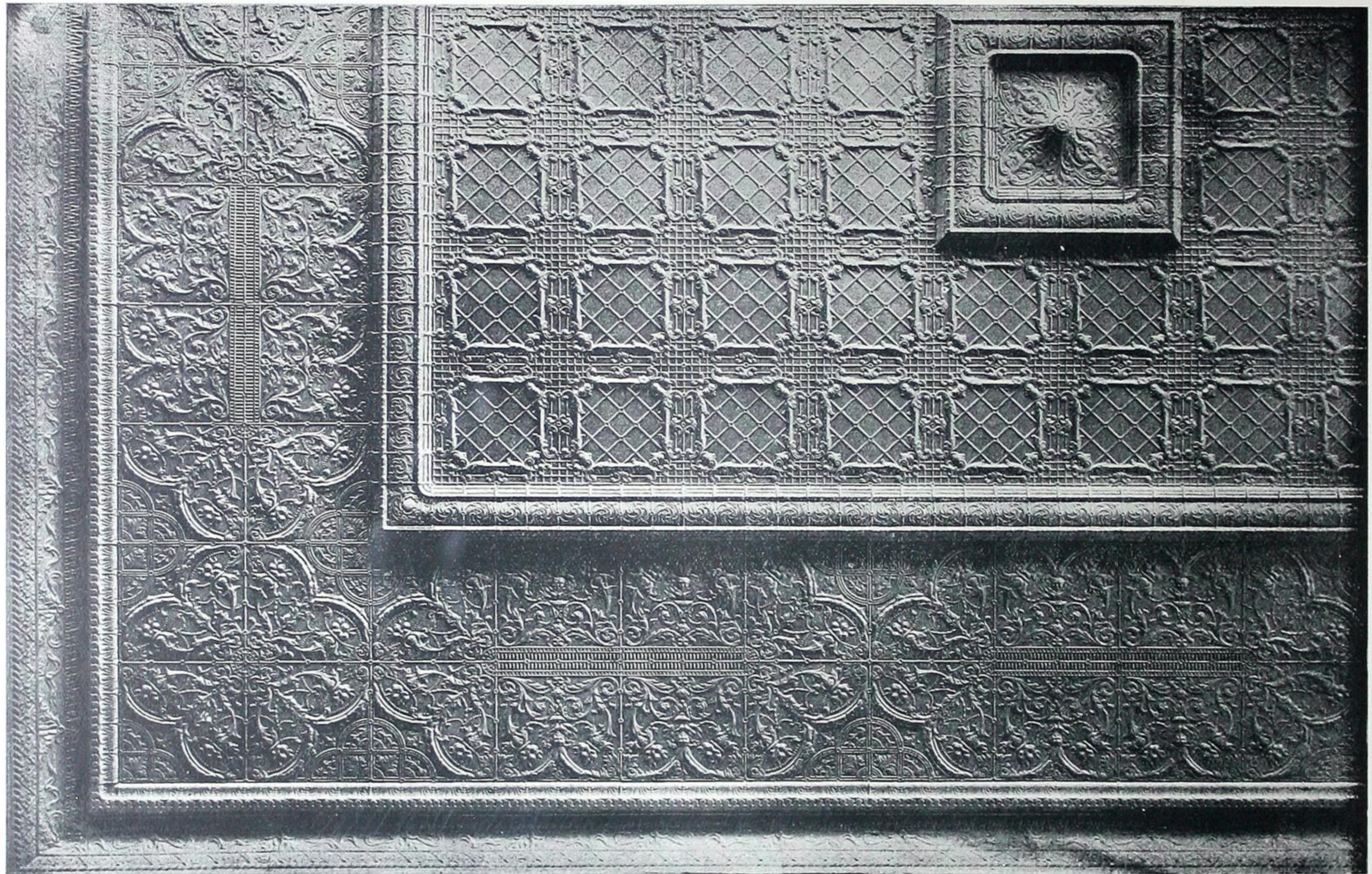

Fig. 3604.

Corner Section, 14 x 21 feet Composed of Cornice No. 339; Moulding No. 910; Border Nos. 441 and 442; Moulding No. 900; Field Plates No. 444; and Centre No. 706.

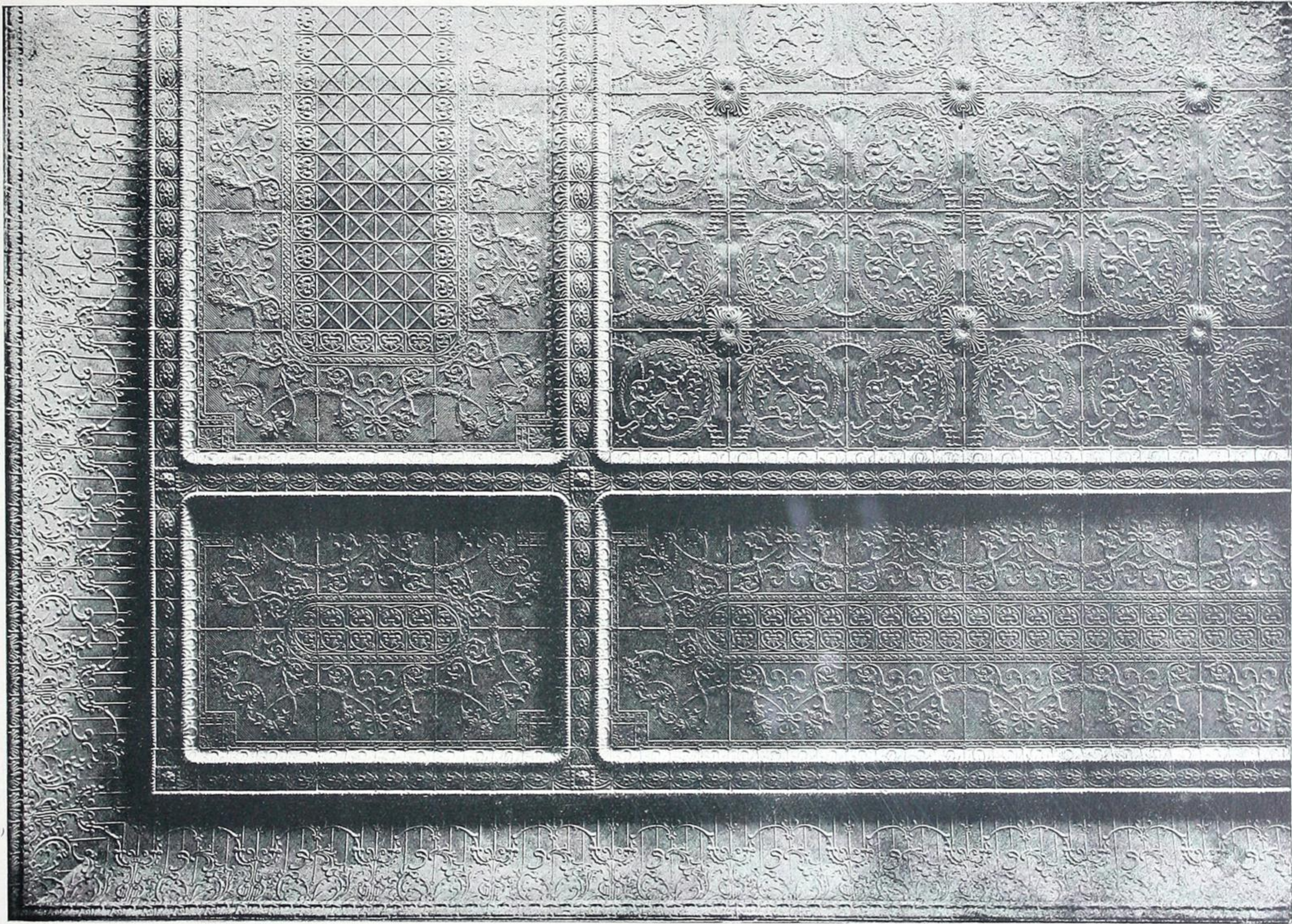

Fig. 3605.

Corner Section, $15\frac{1}{2}$ x $21\frac{1}{2}$ feet. Composed of Cornice No. 339; Moulding No. 904; Border Plates Nos. 435 445 and 446; and Field Plates No 439.

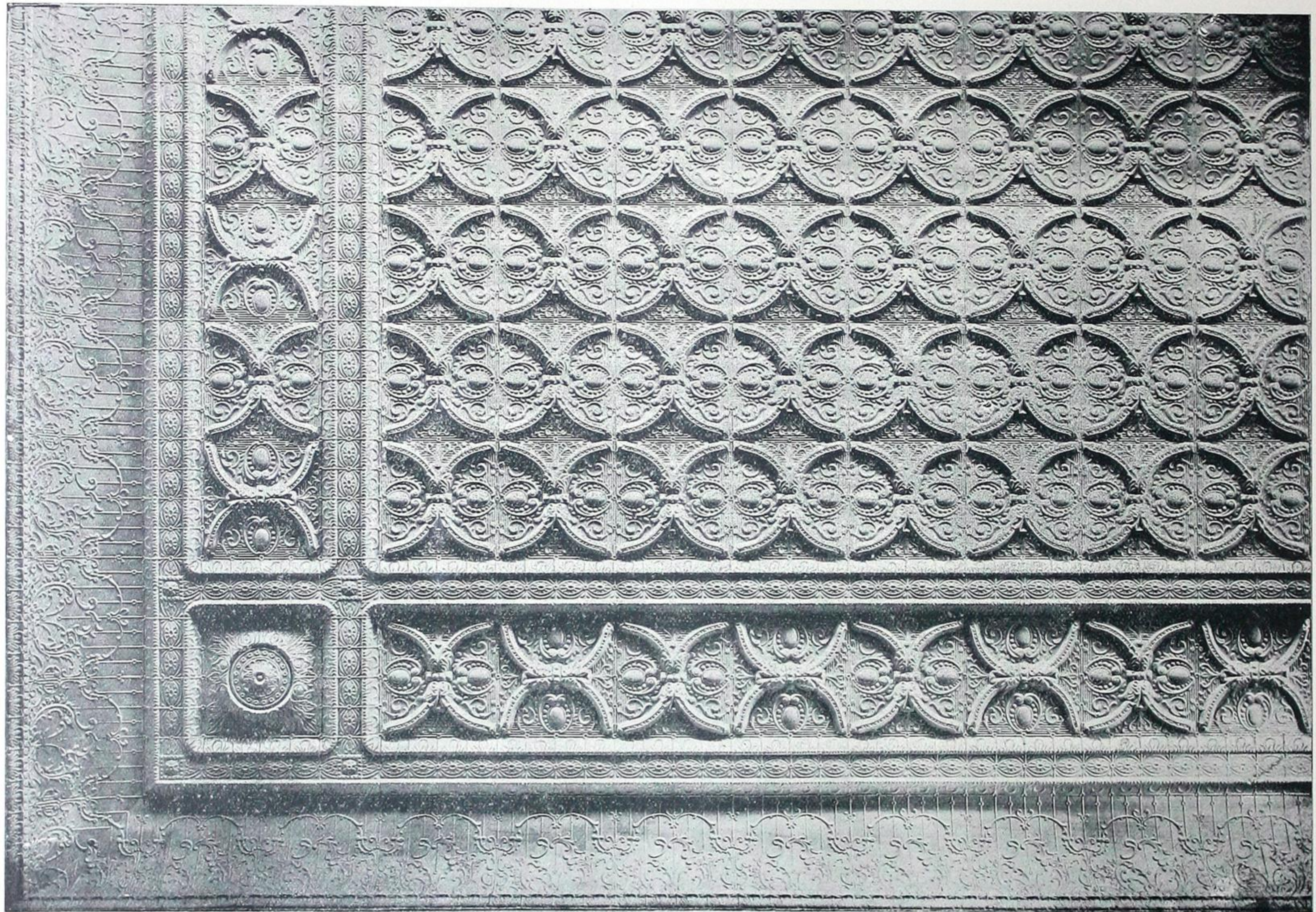

Fig. 3606.

Corner Section, $14\frac{1}{2}$ x $21\frac{1}{2}$ feet Composed of Cornice No. 339; Moulding No. 904; Border No. 477; Corner Plate No. 431; and Field Plates No. 477.

THE METALLIC ROOFING COMPANY OF CANADA, LIMITED, TORONTO, CANADA.

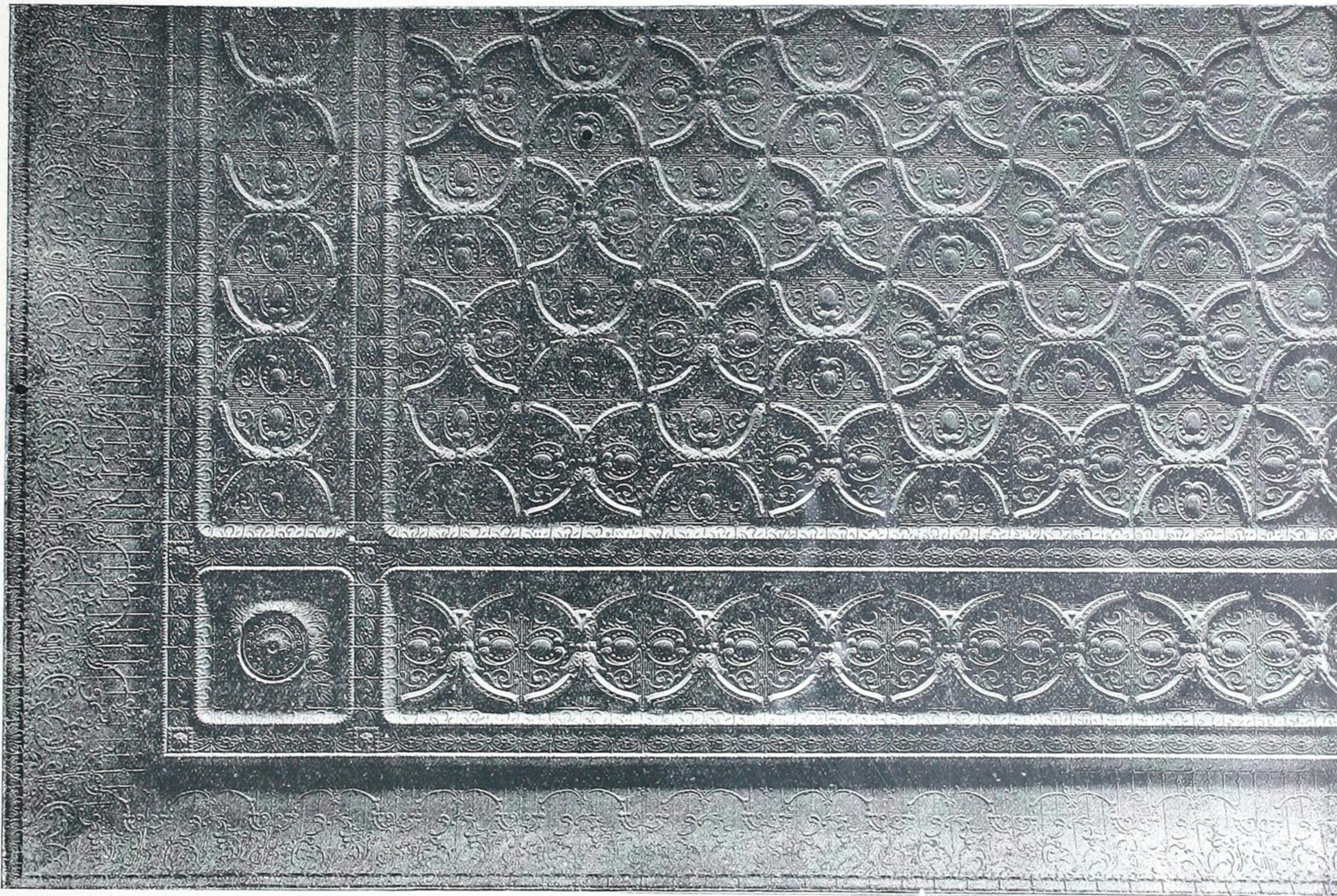

Fig. 3607.

Corner Section, 14 x 21 feet. Composed of Cornice No. 339; Moulding No. 904; Border No. 477; Corner Plate No 431; and Field Plates No. 477.

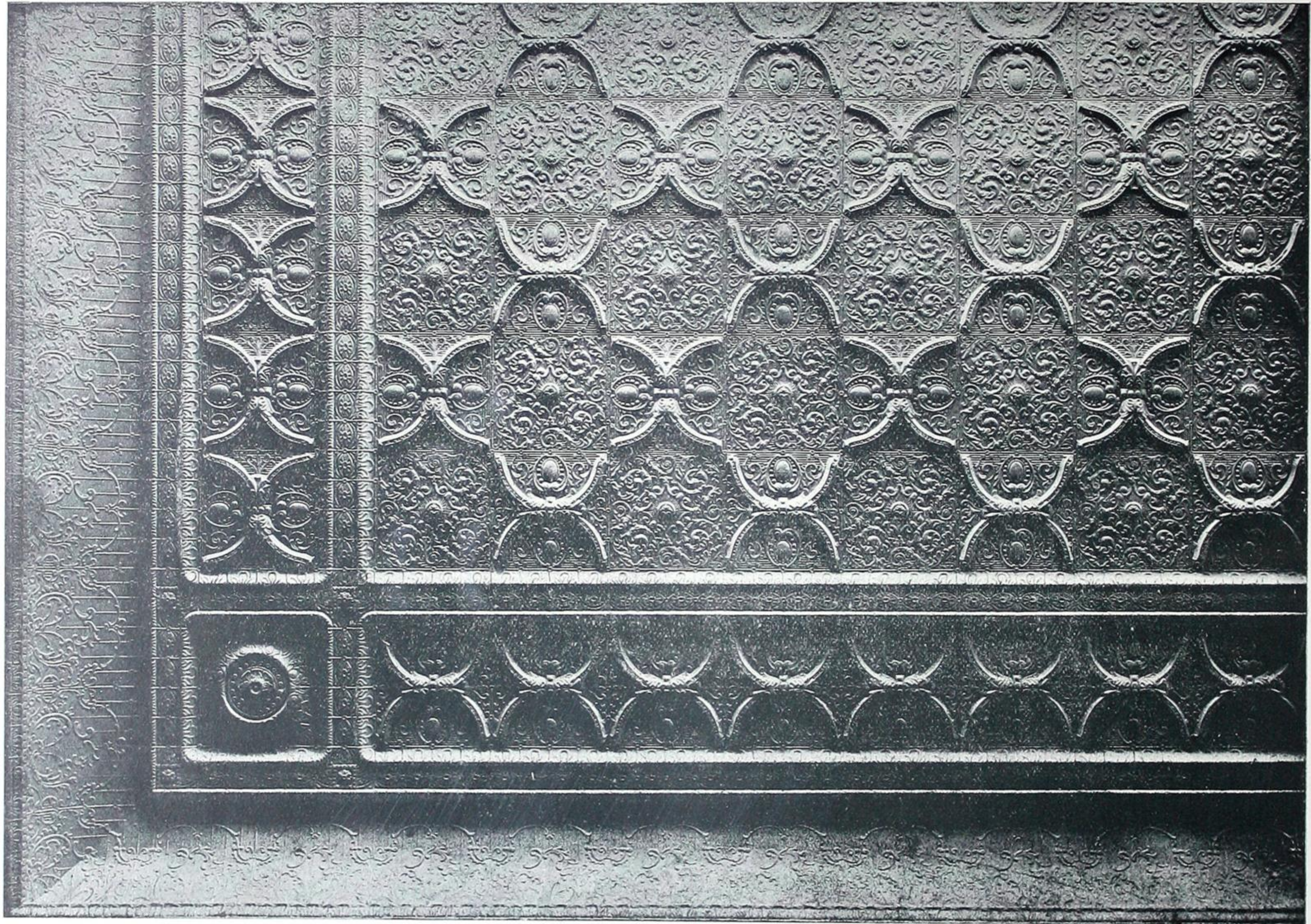

Fig. 3608.

Corner Section $14\frac{1}{2}$ x $21\frac{1}{2}$ feet. Composed of Cornice No. 339; Moulding No. 904; Border No. 477; Corner Plate No. 431; Field Plates Nos. 477 and 440.

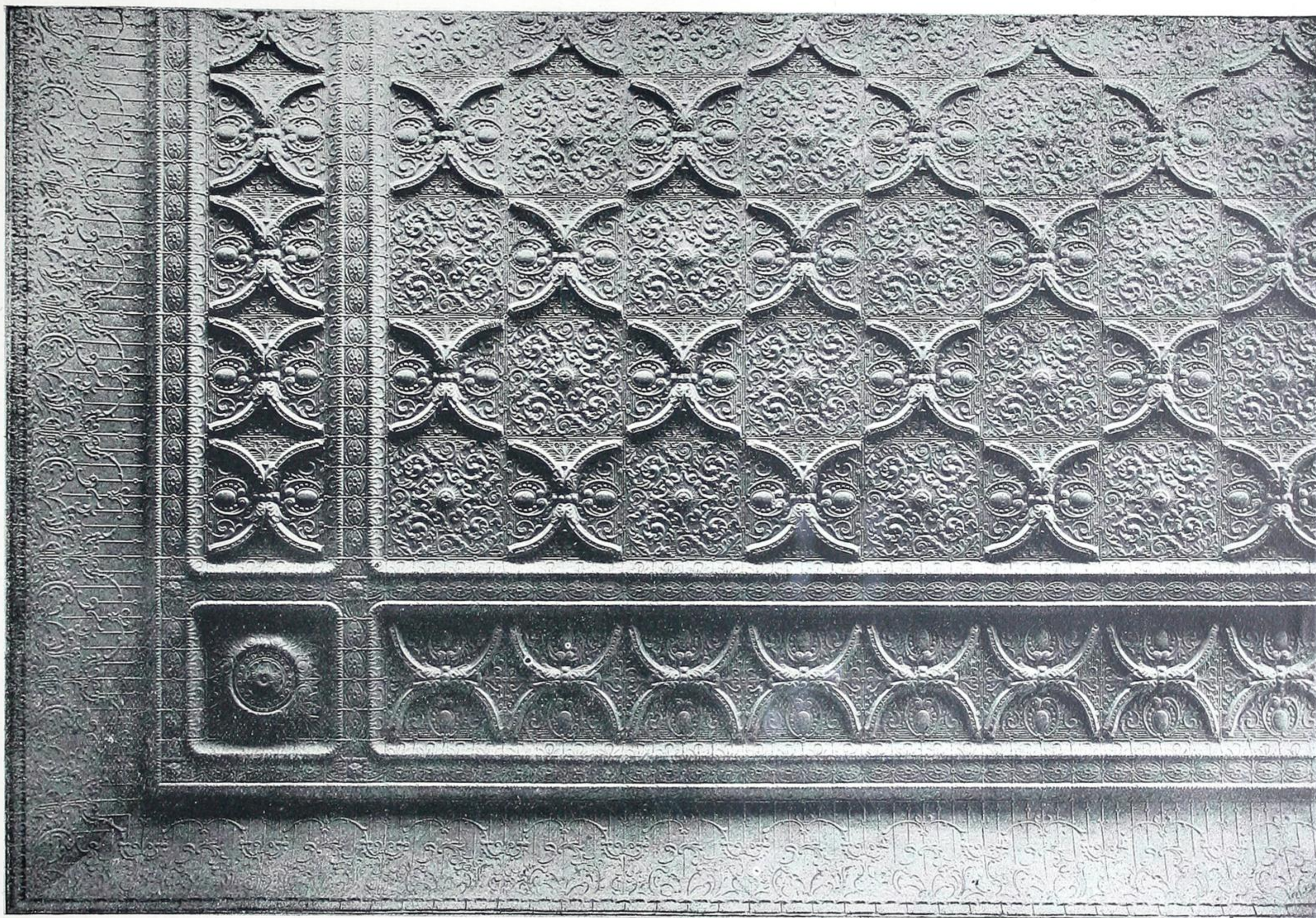

Fig. 3609.

Corner Section $14\frac{1}{2}$ x $21\frac{1}{2}$ feet. Composed of Cornice No. 339; Moulding No. 904; Border No. 477; Corner Plate No. 431; Field Plates Nos. 477 and 440.

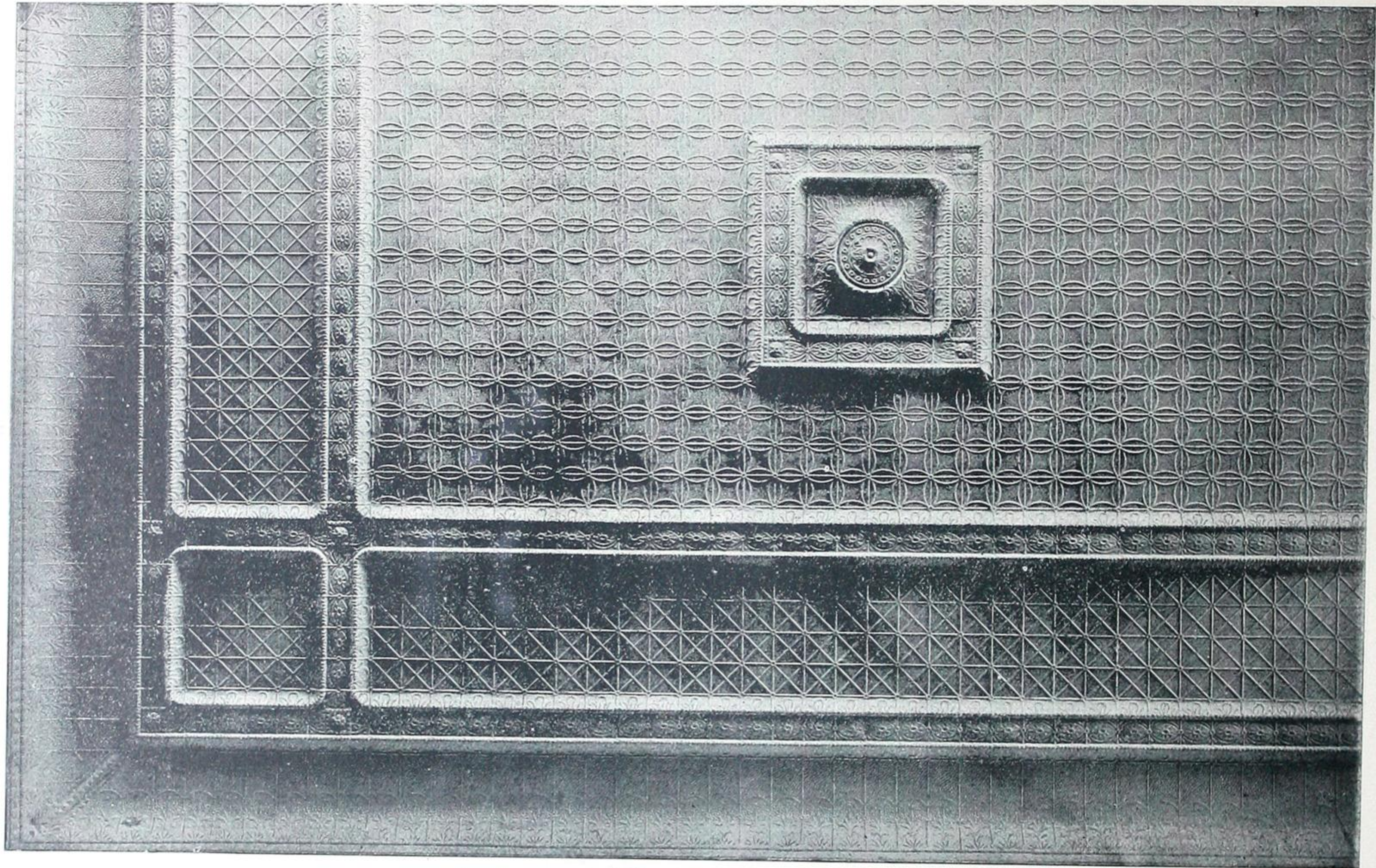

Fig. 3610.

Corner Section $13\frac{1}{2}$ x $21\frac{1}{2}$ feet. Composed of Cornice No. 301; Moulding No. 904; Border No. 435; Moulding No. 904; Field Plates No. 432; and Centre No. 705.

THE METALLIC ROOFING COMPANY OF CANADA, LIMITED, TORONTO, CANADA.

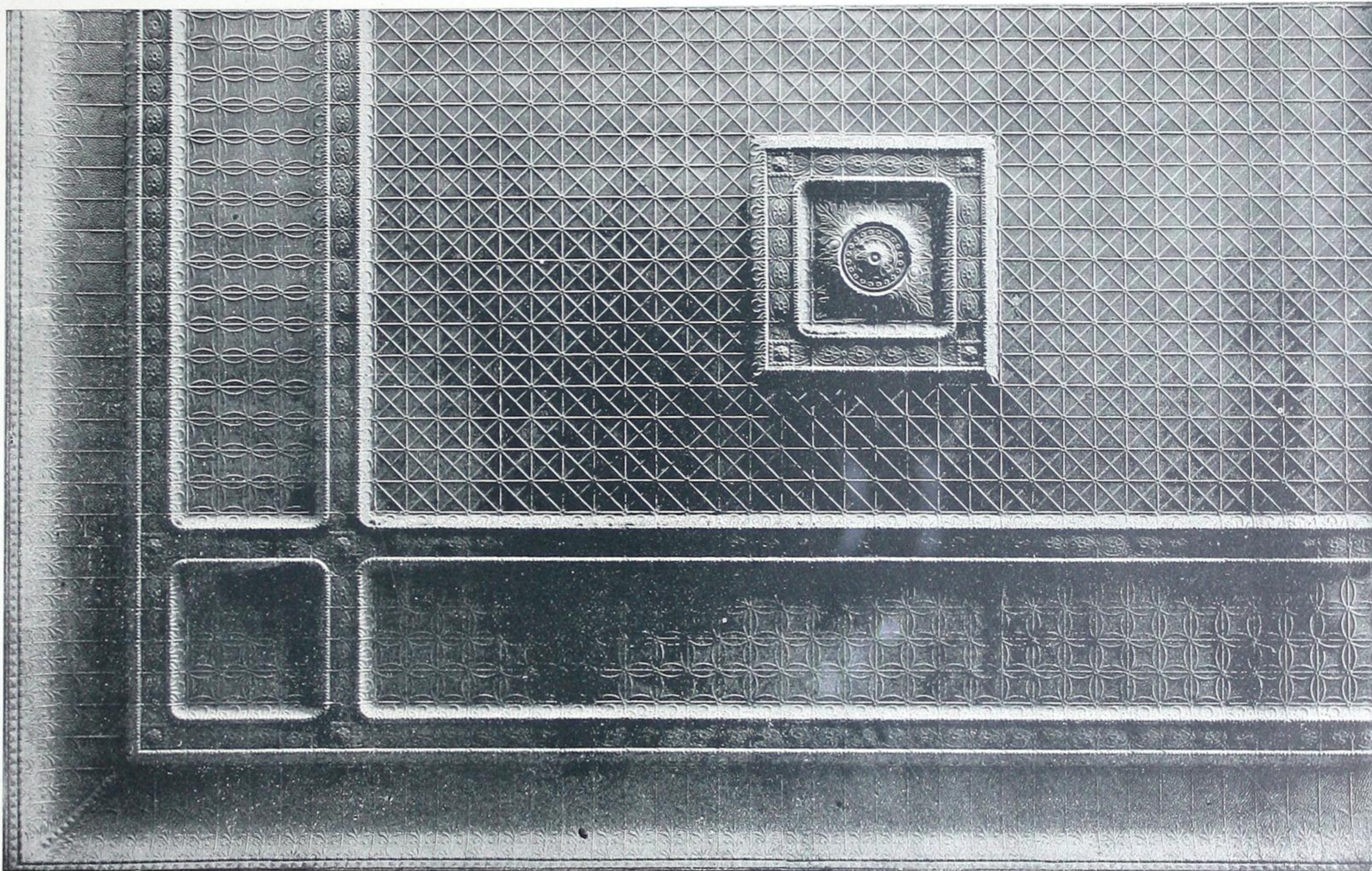

Fig. 3611.

Corner Section $13\frac{1}{2} \times 21\frac{1}{2}$ feet. Composed of Cornice No. 301 ; Moulding No. 904 ; Border No. 432 ; Moulding No. 904 ; Field Plates No. 435 ; and Centre No. 705.

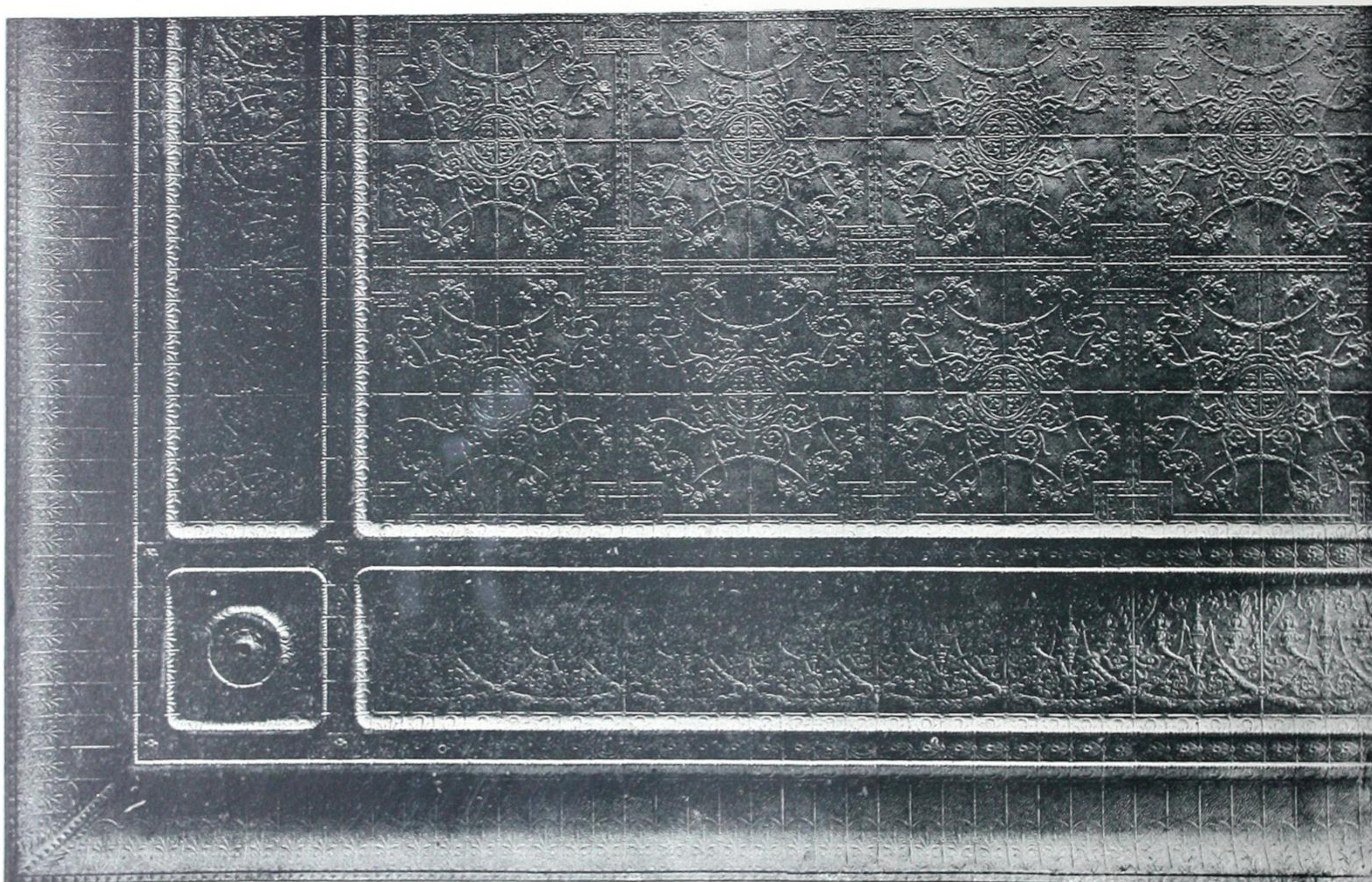

Fig. 3612.

Corner Section, $13\frac{1}{2} \times 21\frac{1}{2}$ feet. Composed of Cornice No. 301; Moulding No. 904; Border No. 806; Corner Plate No. 431; Moulding No. 904; and Field Plates No. 445.

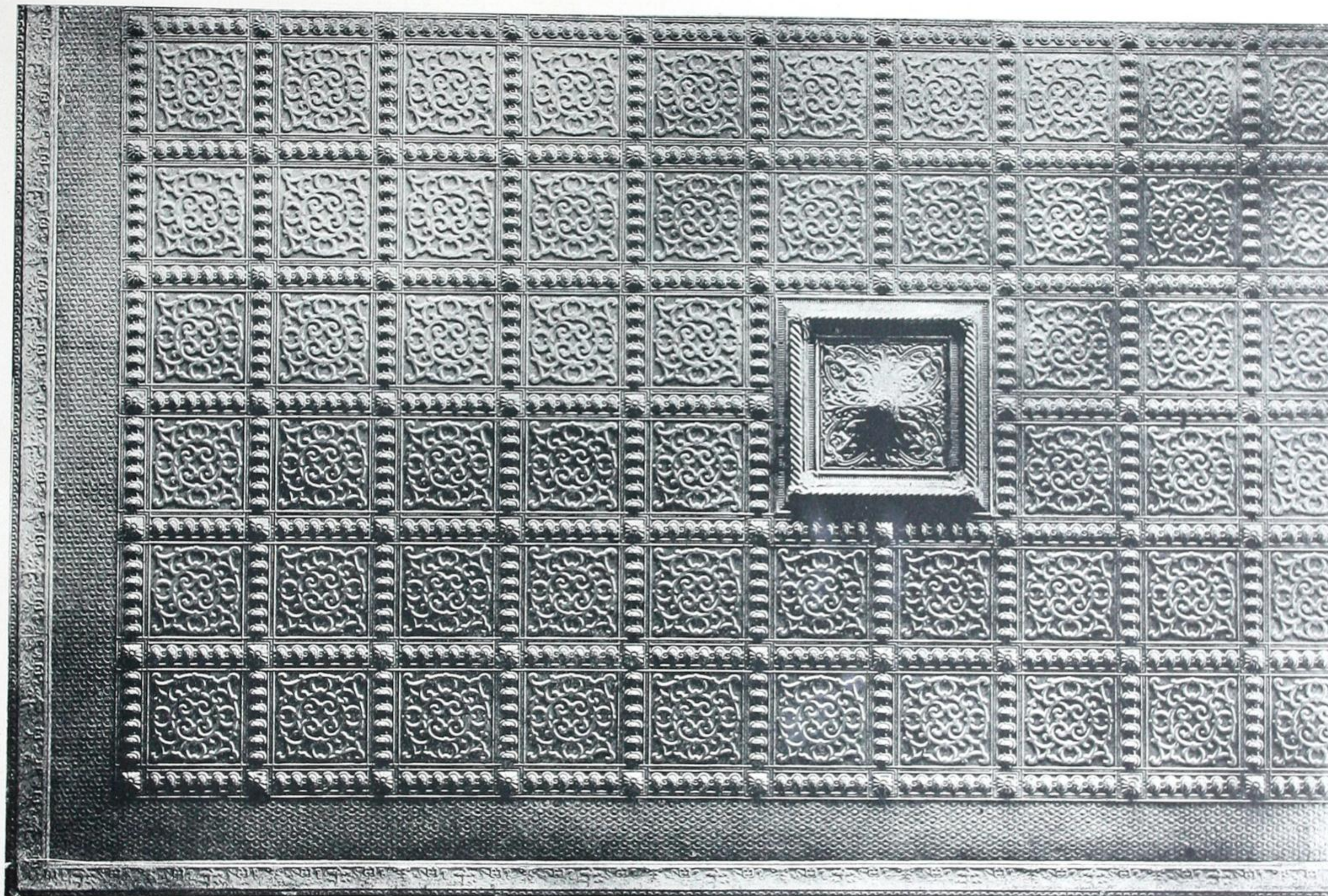

Fig. 3613.

Corner Section, 14 x 21 feet. Composed of Cornice No. 337; Border No. 814; and Field Plates No. 476.

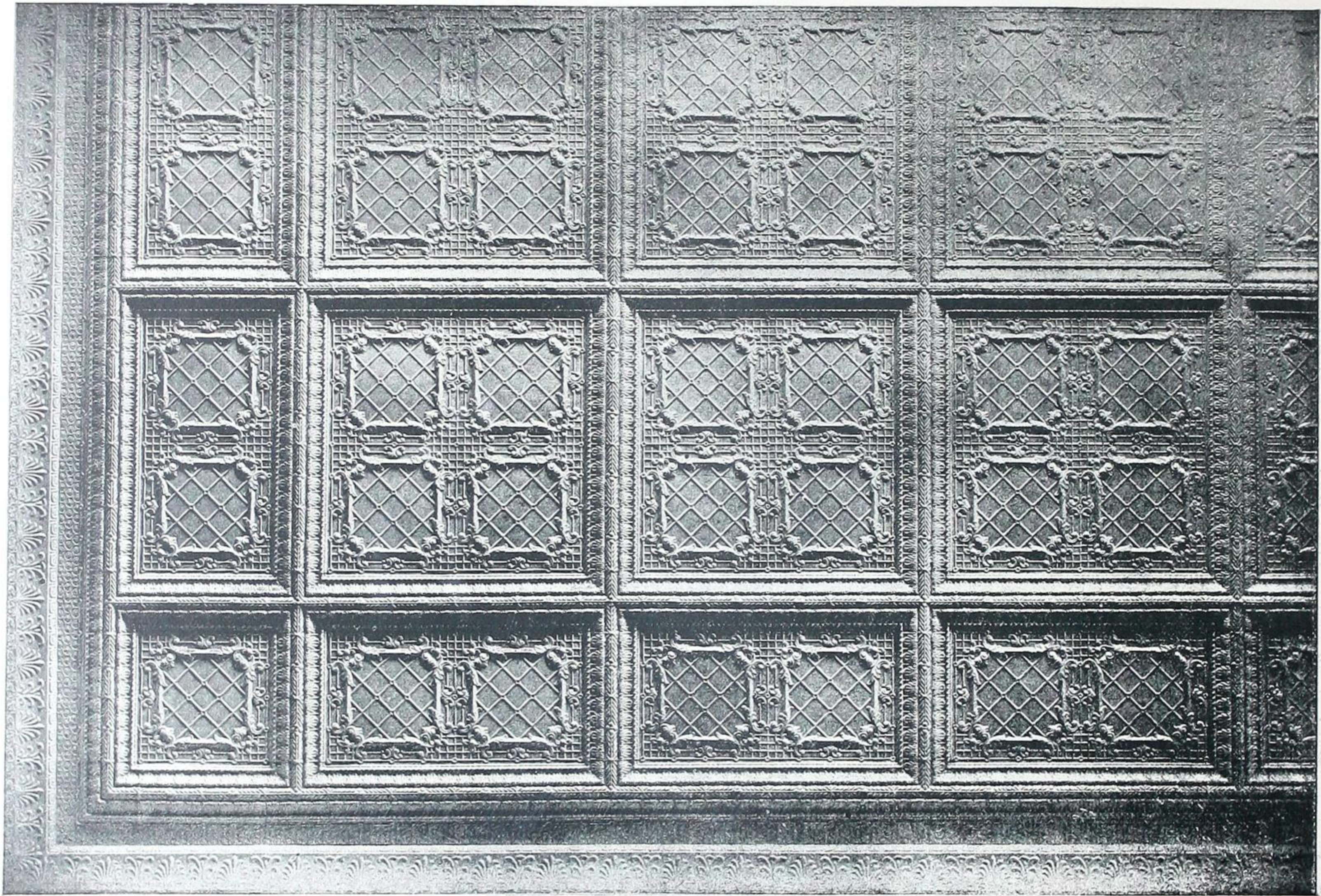

Fig. 3614.

Corner Section, 14 x 21 feet. Composed of Cornice No. 337; Filler No. 813; Moulding No. 941, and Field Plates No. 444.

Ceiling Design.

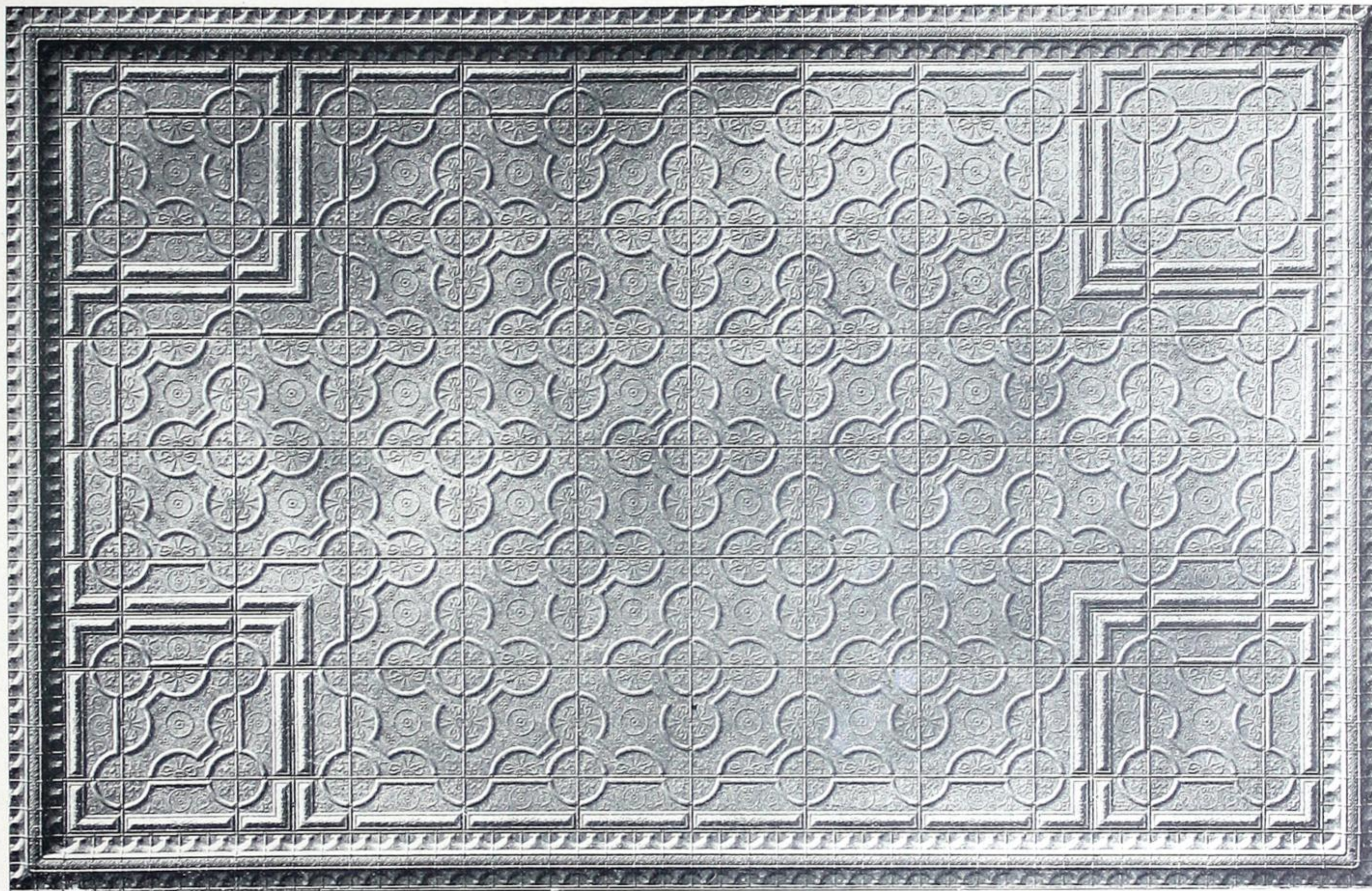

Fig. 3615.

Section 16 x 24 feet. Composed of Moulding No. 941; Ell No. 944; Border No. 483; Field Plate No. 482; Corner No. 482, 483, and 484.

Ceiling Design.

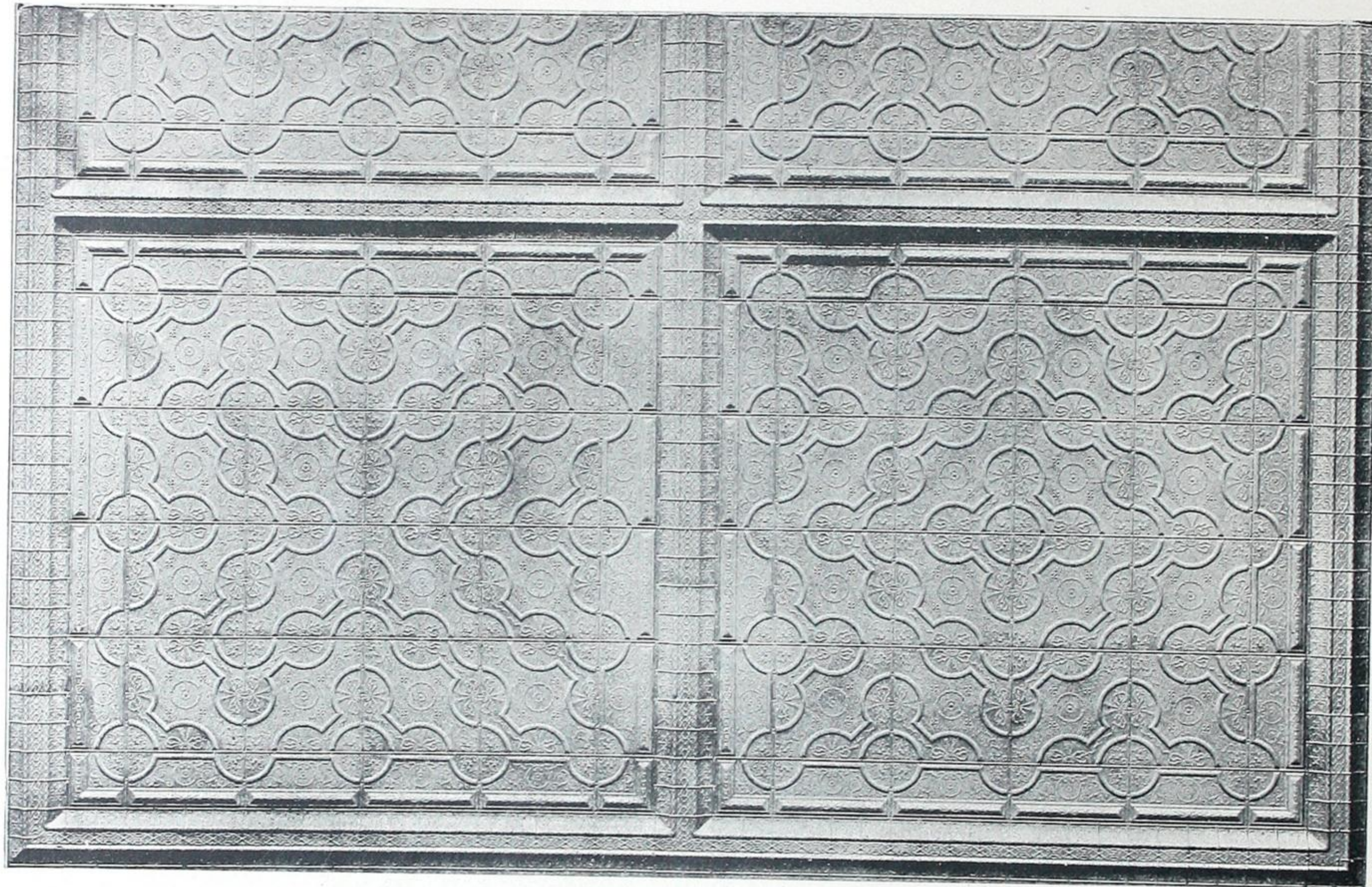

Fig. 3616.

Section 15 x 23 feet. Composed of Moulding No. 904; Cross No. 905; Tee No. 906; Ell No. 907; Border Nos. 483 and 484; Plates No. 482.

Ceiling Design.

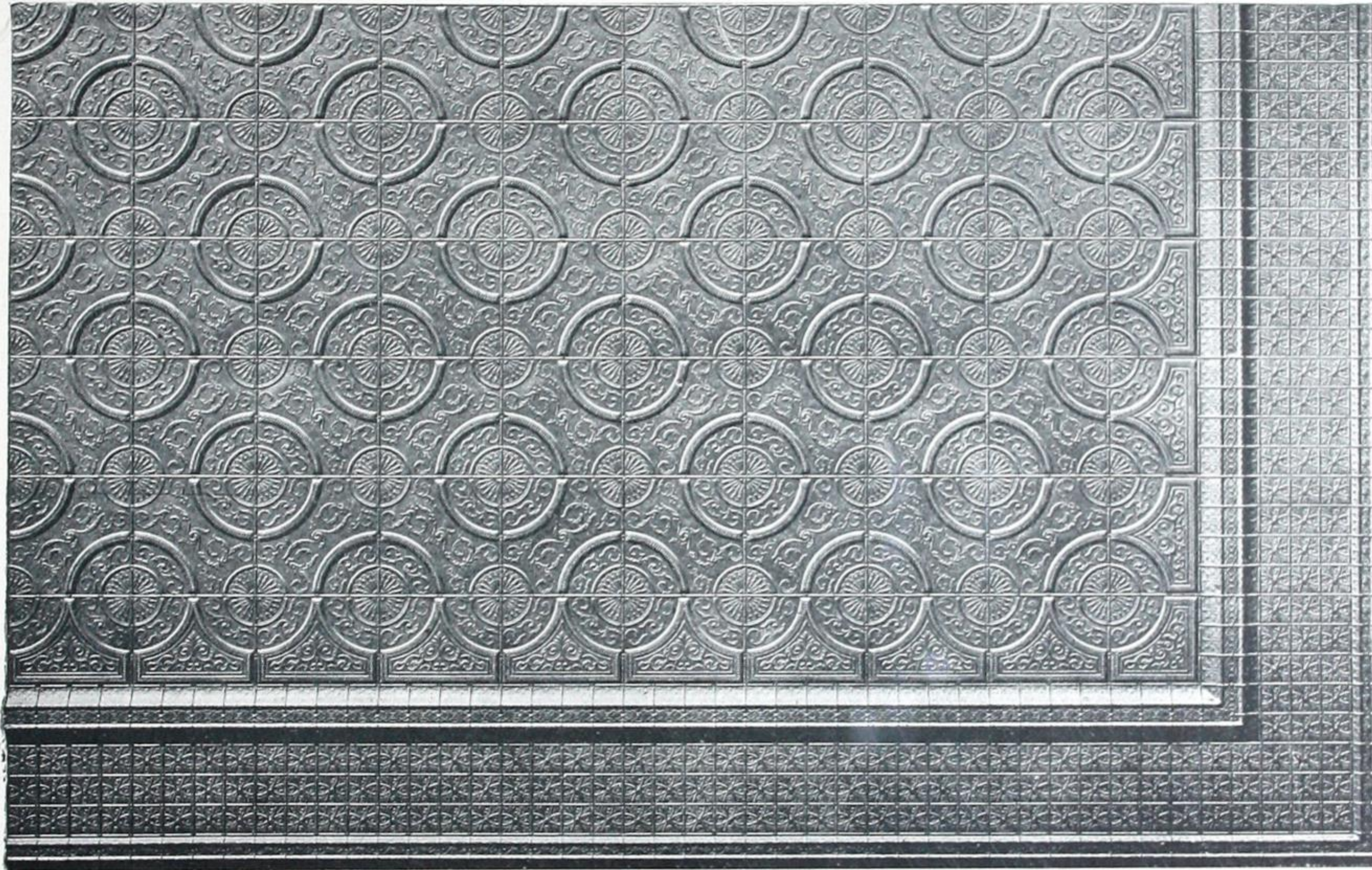

Fig. 3617.

Section 15 x 23 feet. Composed of Mouldings Nos. 904 and 908; Border No. 432; Field Plates Nos. 485, 486, and 487.

Ceiling Design.

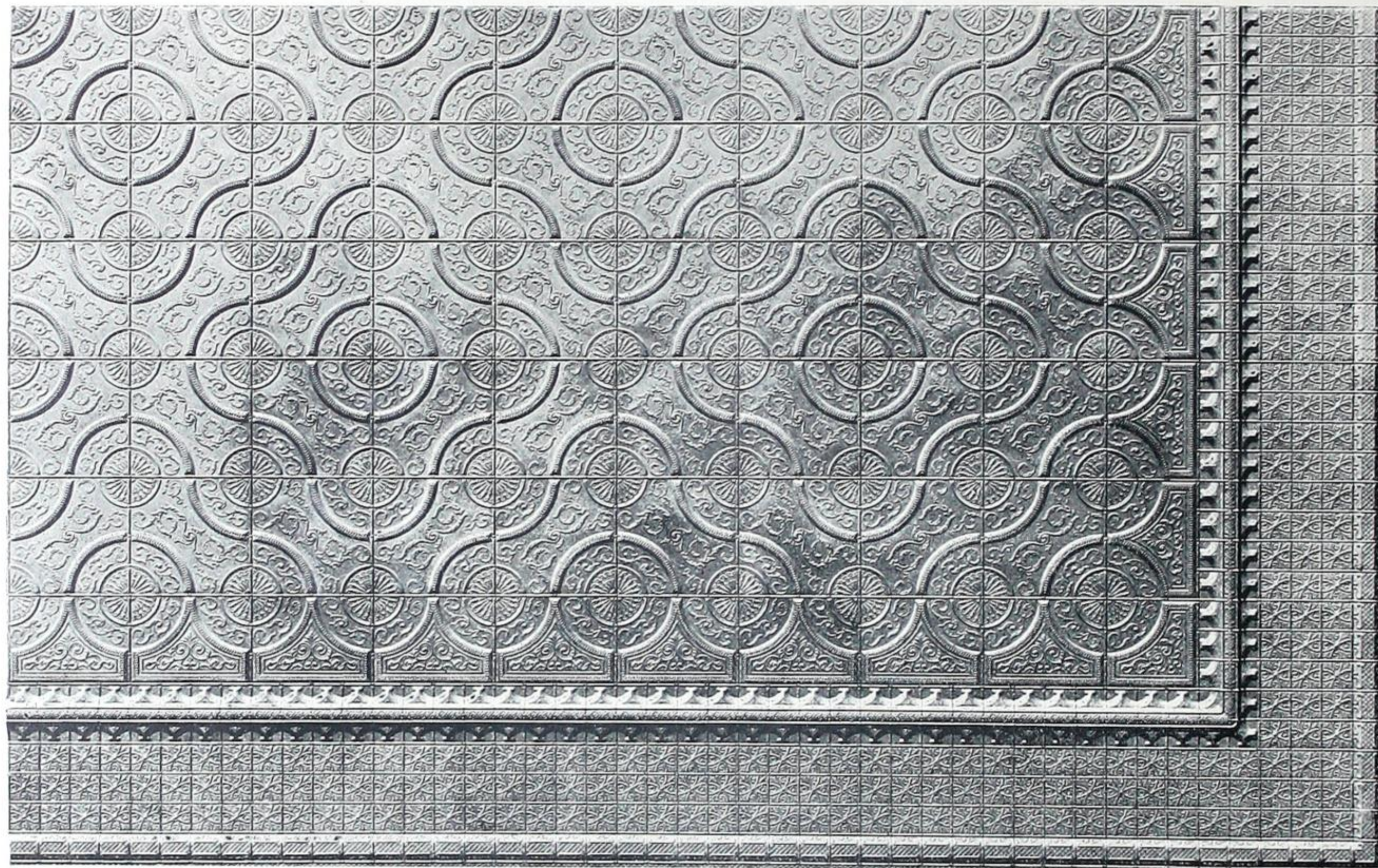

Fig. 3618.

Section 15 x 23 feet. Composed of Mouldings Nos. 941 and 915; Border No. 432; Field Plates Nos. 485, 486 and 487.

THE METALLIC ROOFING COMPANY OF CANADA, LIMITED, TORONTO, CANADA.

Ceiling Design.

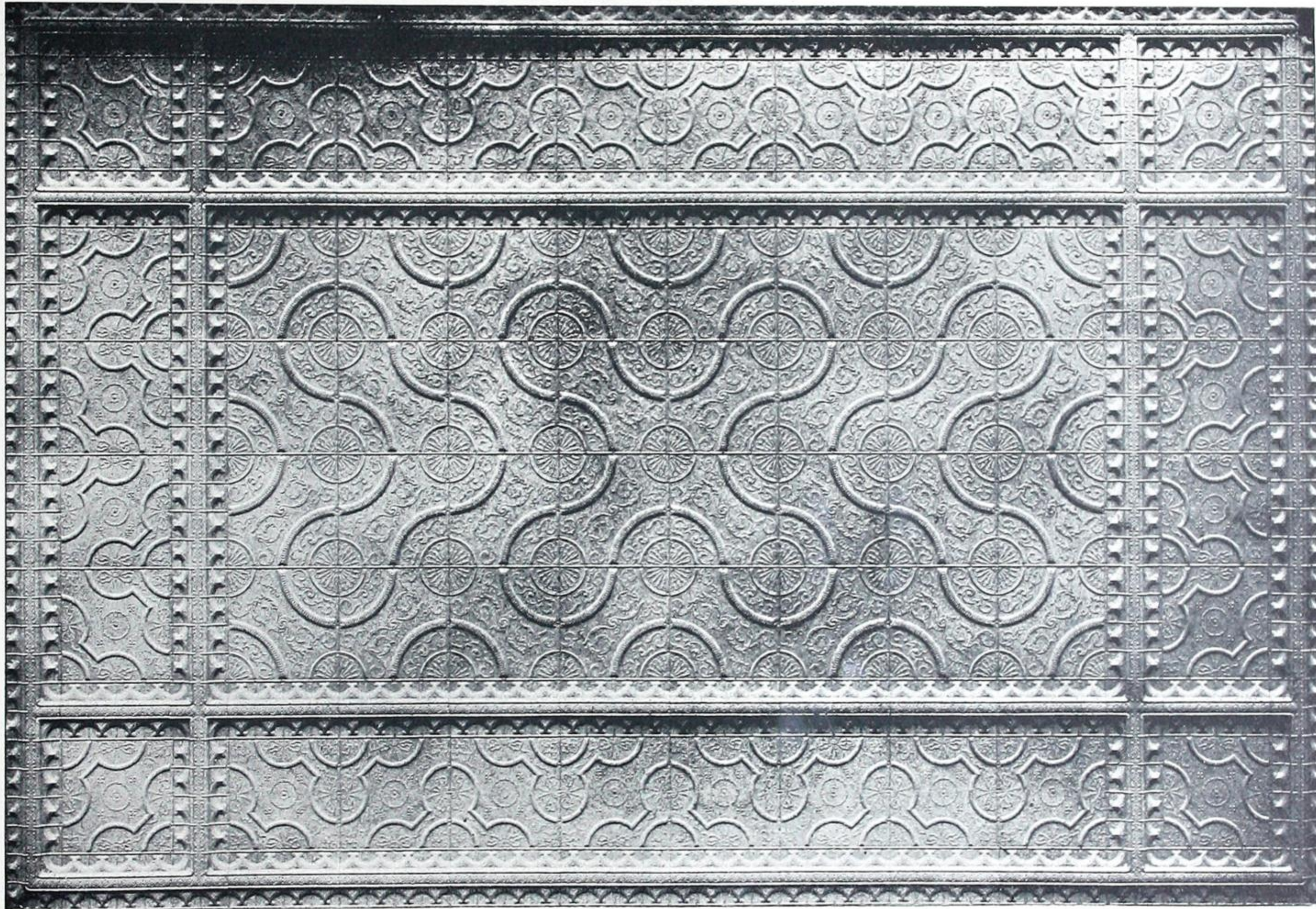

Fig. 3619.

Section 16 x 24 feet. Composed of Moulding No. 941; Cross No. 942; Ell No. 943; Tee No. 944; Border No. 482; Field Plates No. 485; Corner No. 482.

Ceiling Design.

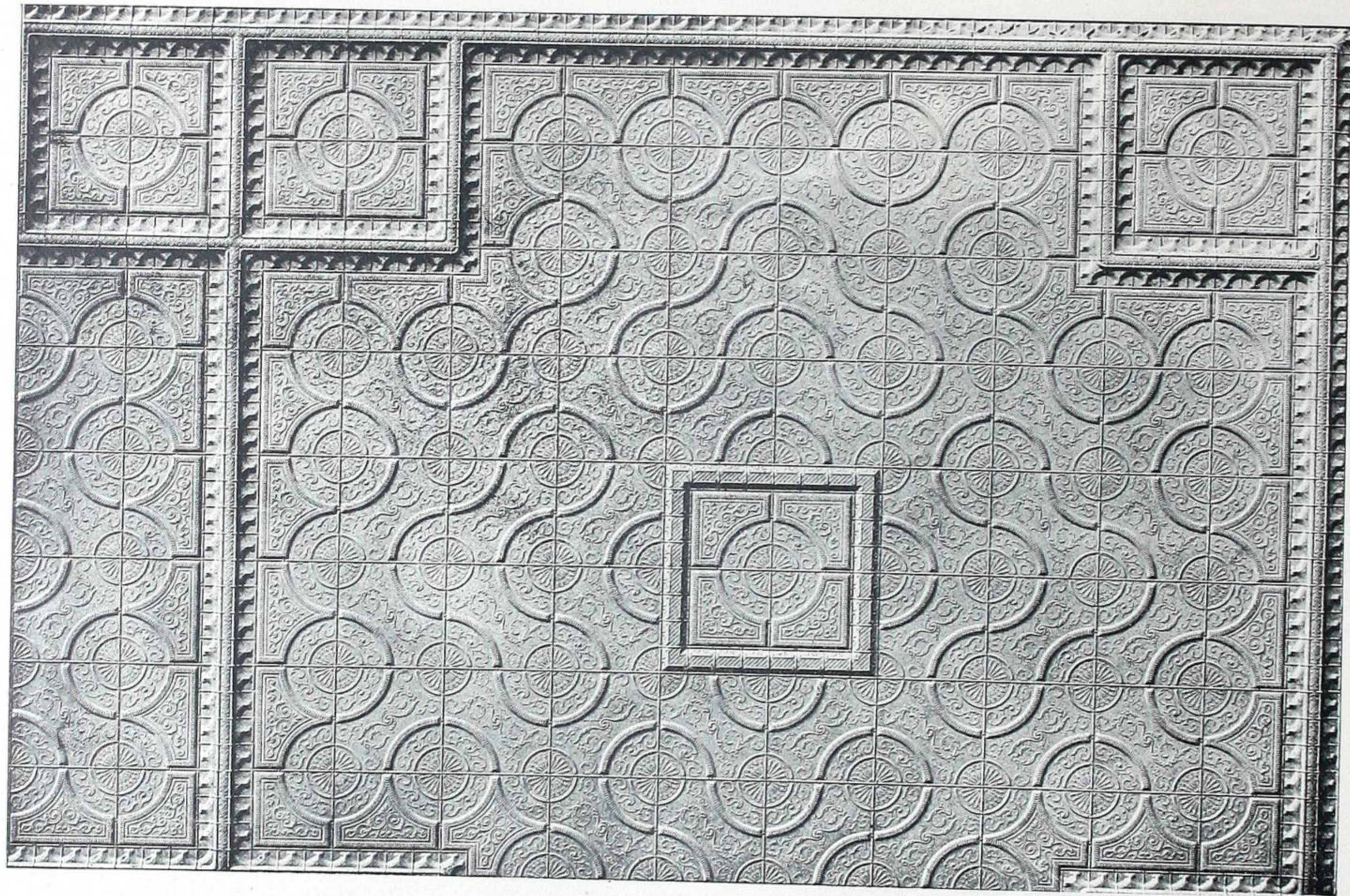

Fig. 3620.

Section 17 x 24½ feet. Composed of Moulding No. 941; Cross No. 942; Tee No. 943; Ell No. 944; Centre No. 487; Corner No. 487; Field Plates No. 485.

Ceiling Design.

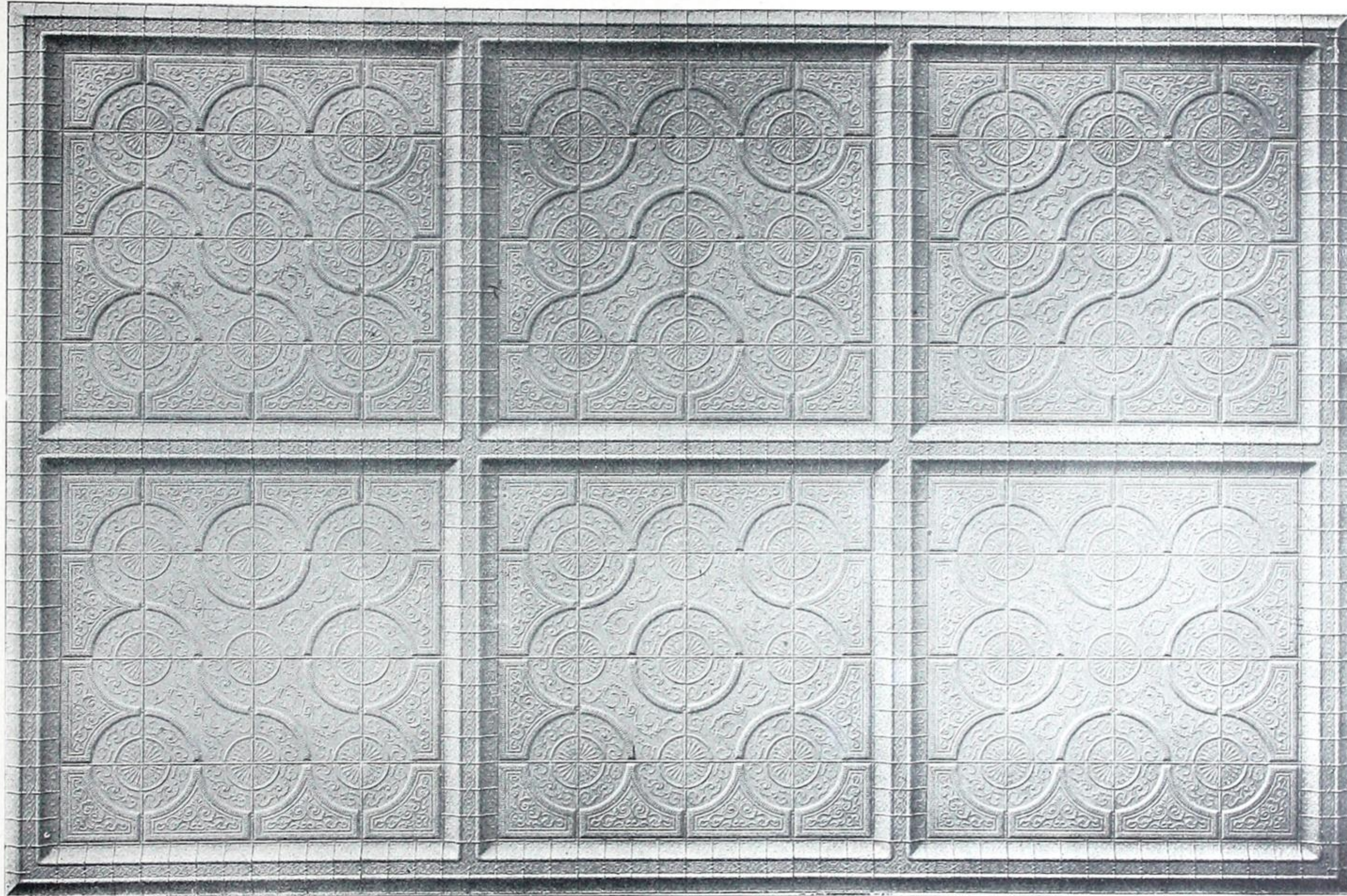

Fig. 3621.

Section 17 x 25 feet. Composed of Moulding No. 904; Cross No. 905; Tee No. 906; Ell No. 907; Plates Nos. 485, 486 and 487.

Ceiling Design.



Fig. 3700.

Showing Ceiling covered with Plates No. 417; Border No. 804; Moulding No. 924, and Cornice No. 302. Reproduced from a photograph.

Ceiling Design.

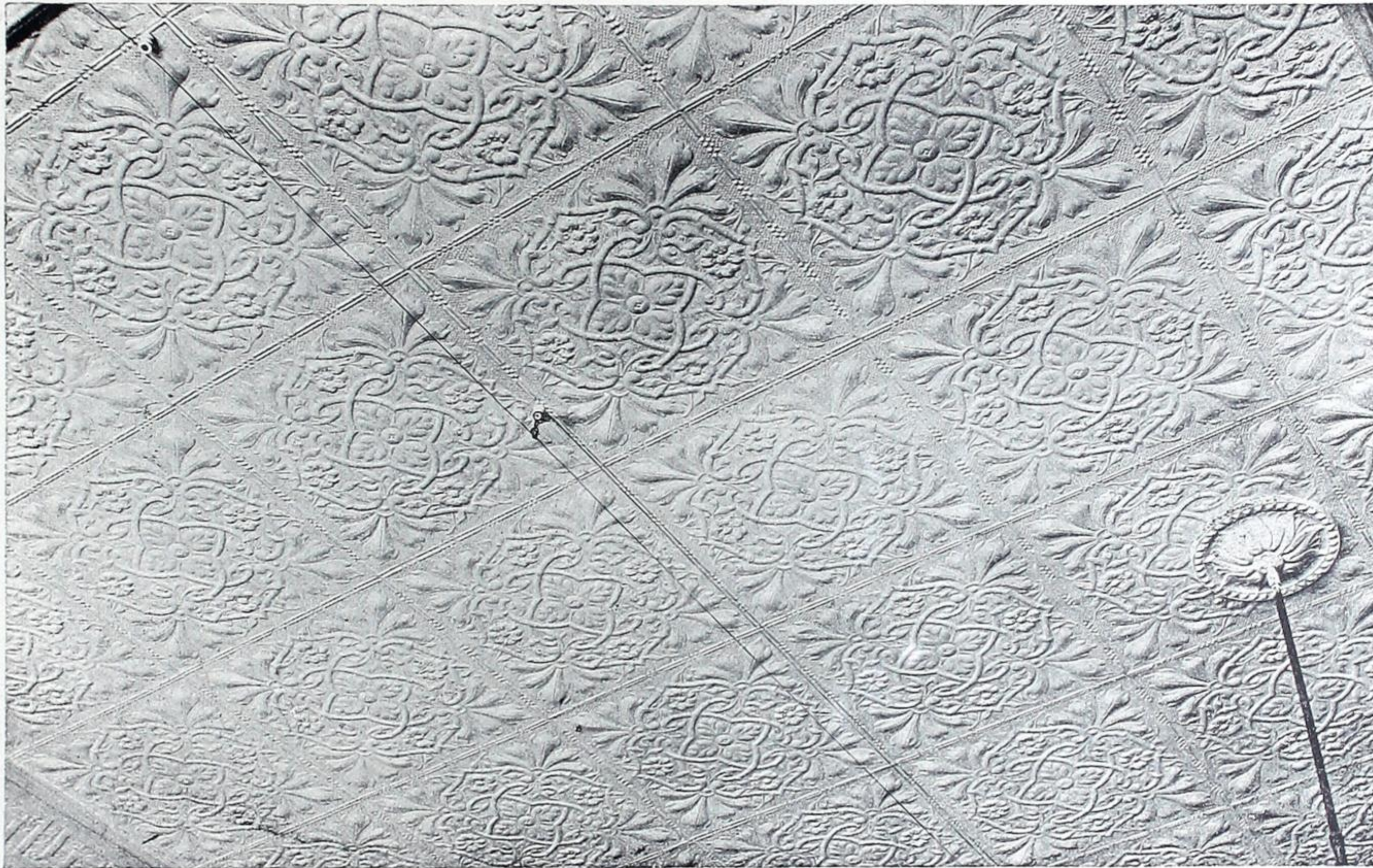

Fig. 3701.

Shows Section of Ceiling done with Plates No. 419 ("Louis XVI"). Reproduced from a photograph.



Ceiling Design.

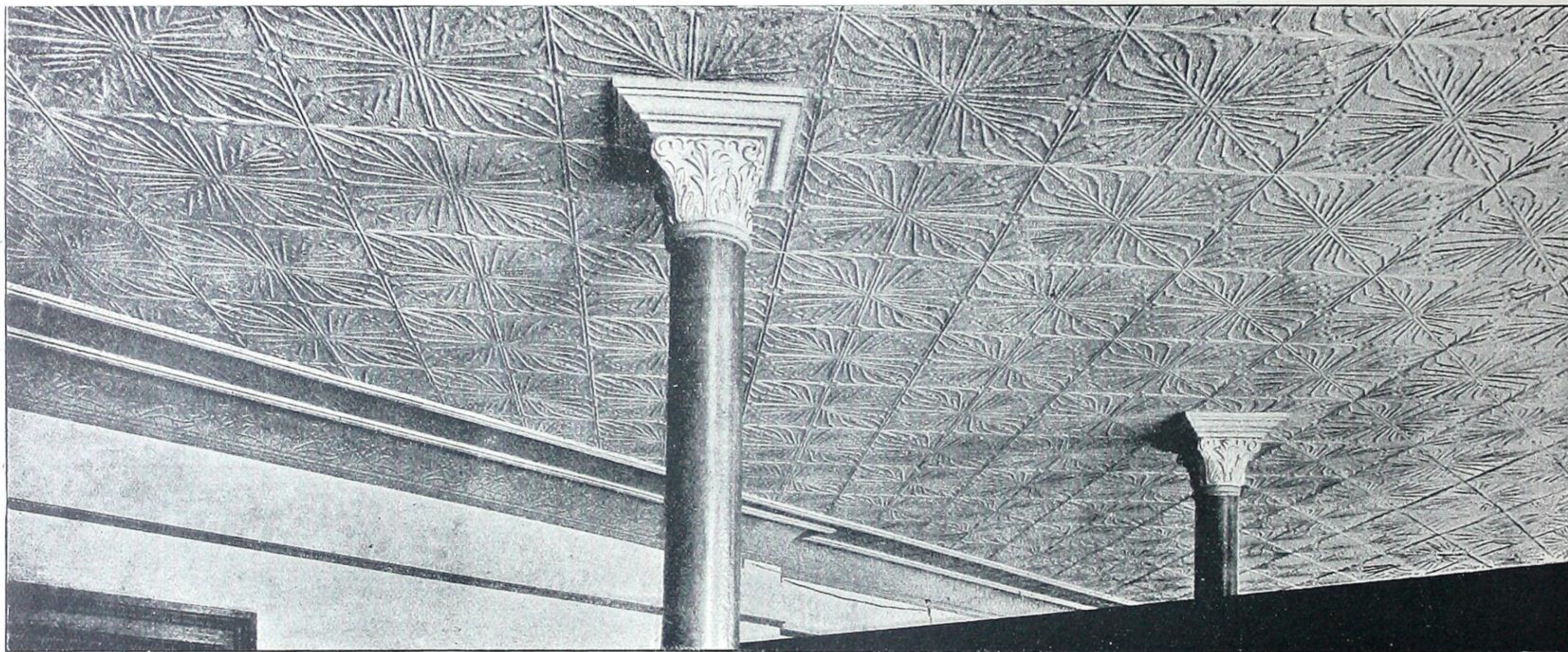

Fig. 3702.

Shows Section of Ceiling done with Plates No. 430. Reproduced from a photograph.

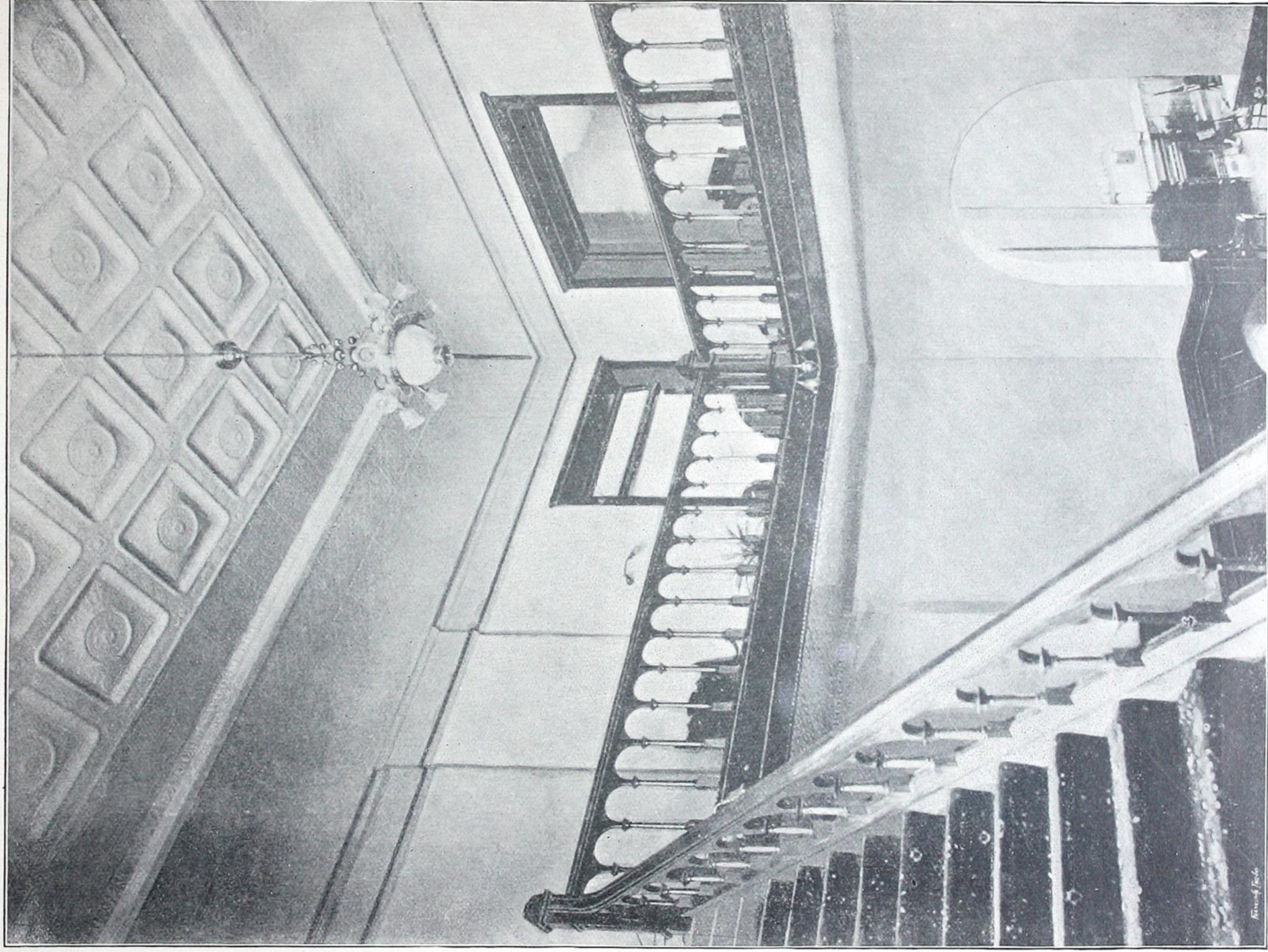

Fig. 3703.

View of Ceiling in hotel lobby, done with Centres No. 705. Reproduced from a photograph.

THE METALLIC ROOFING COMPANY OF CANADA, LIMITED, TORONTO, CANADA.

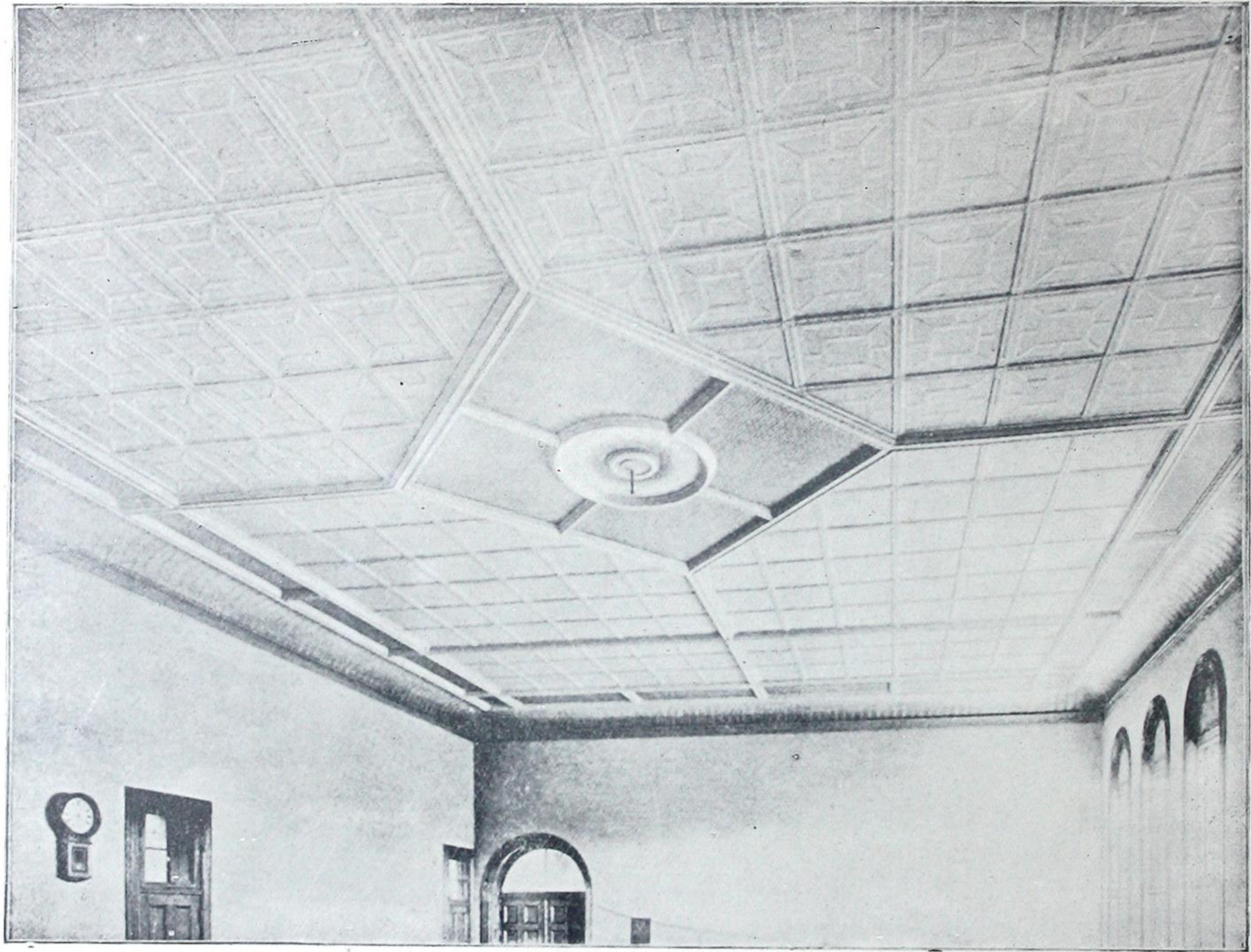

Fig 3704.

Illustrates a Ceiling covered with Plates No. 408. Reproduced from a photograph.

THE METALLIC ROOFING COMPANY OF CANADA, LIMITED, TORONTO, CANADA.

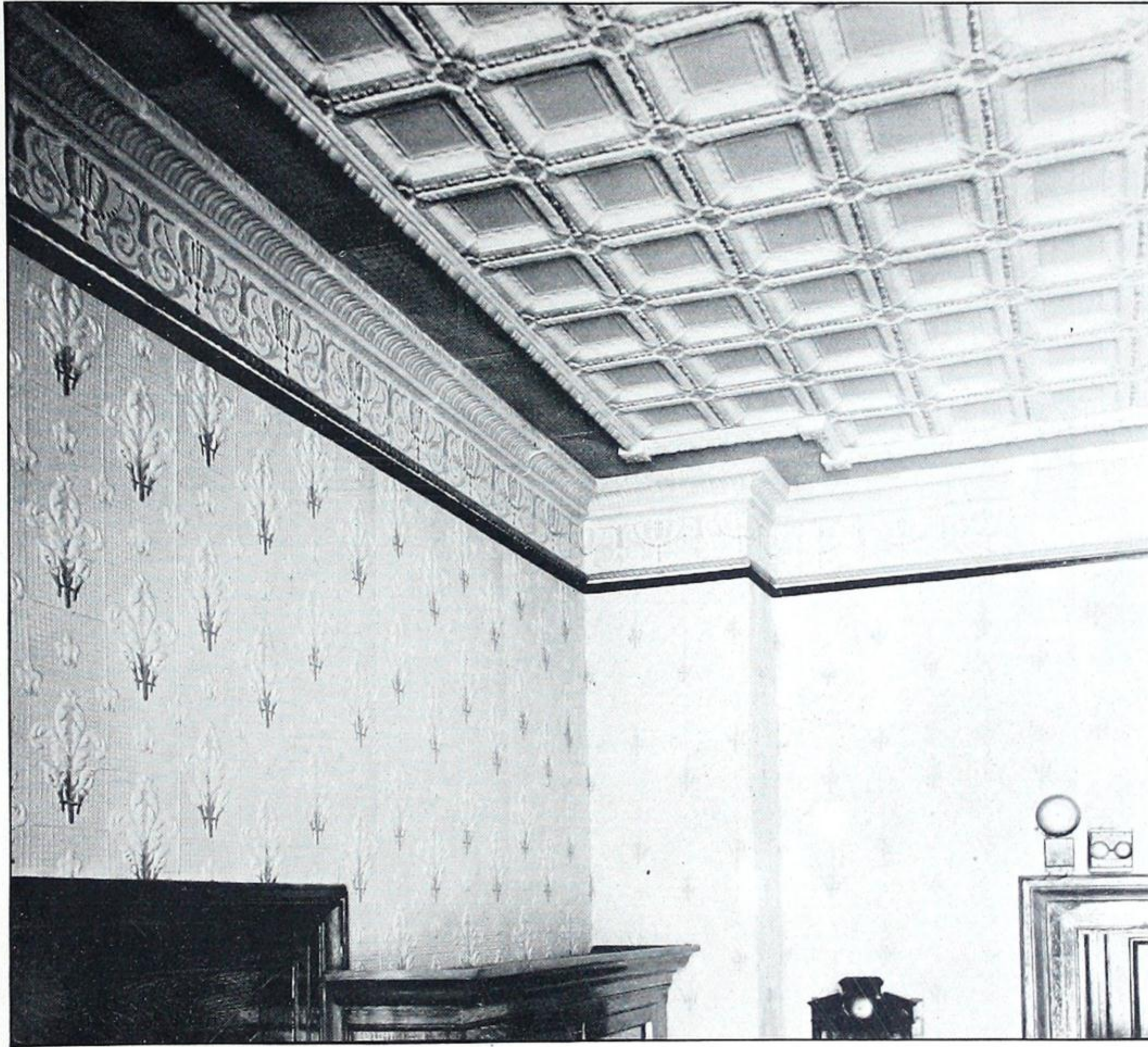

Fig. 3705.

Room in Archbishop's Palace, Montreal.

Ceiling Plates No. 403; Mouldings No. 920; Border No. 813; Combined Cornice and Frieze No. 809; and Walls No. 418.



Fig. 3706.

Illustrates a Ceiling done with Plates No. 404, panelled off with extra large mouldings and mock beams. Reproduced from a photograph.
A very effective Ceiling for large rooms.



Fig. 3707.—Ceiling and Walls in Headquarters Saloon, Toronto.

Plates No. 444; Mouldings No. 920; Border No. 812; Cornice No. 303; Frieze Nos. 807 and 808; Wall Plates No. 436; and Dado Plates Nos. 454 and 457. Reproduced from a photograph.

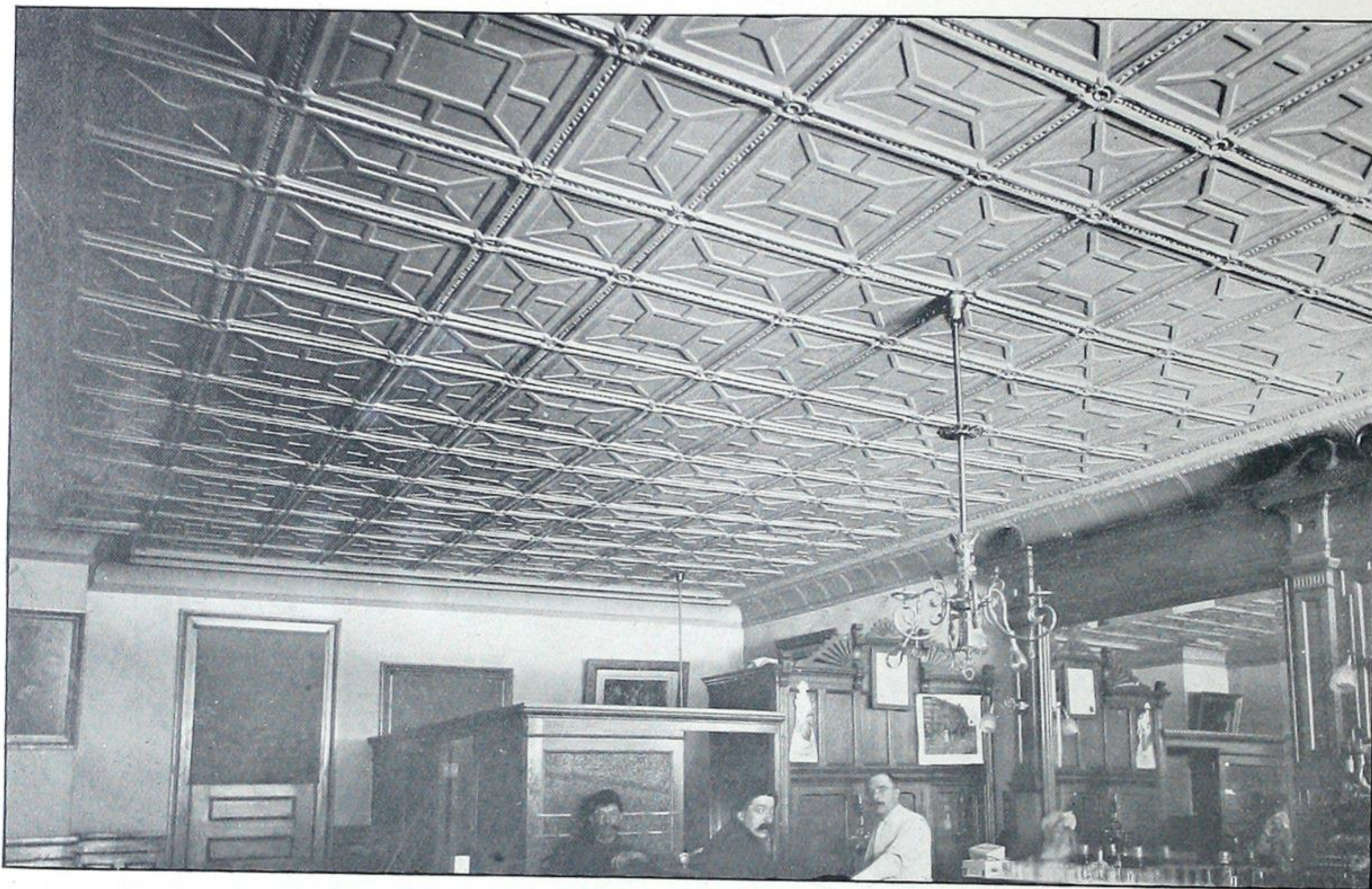

Fig. 3708.

Ceiling in Winnipeg Hotel, Winnipeg.

Plates Nos. 408, 409, and 410 in combination. Reproduced from a photograph.



Fig. 3709.

Ceiling and Walls in British Hotel, Toronto.

Field Plates No. 440; Mouldings No. 921; Border No. 812; Cornice No. 305; Wall Plates No. 418. Reproduced from a photograph.



Fig. 3710.

Ceiling in Lakeview Hotel, Toronto.

Field Plates Nos. 400, 401, 402, 403, and 404; Mouldings No. 915; Border No. 804; and Cornice No. 302. Reproduced from a photograph.



Fig. 3711.

Ceiling in Dining Room, Walker House, Toronto.

Field Plates No. 444; Mouldings No. 908; Border No. 812; Cornice No. 301, and Frieze No. 446. Reproduced from a photograph.



Fig. 3712.

Ceiling in Show Room Eckhart Casket Company, Toronto.
Field Plates No. 417; Mouldings No. 920; Border No. 812, and Cornice No. 305. Reproduced from a photograph.



Fig. 3713.—Ceiling in Boisseau's Clothing Store, Toronto.

Field Plates No. 423; Mouldings No. 920; Border No. 812, and Cornice No. 305. Beam covered on sides with Plates Nos. 456 and 459, and on Soffit with Plates No. 402, with special angle moulding. Reproduced from a photograph.

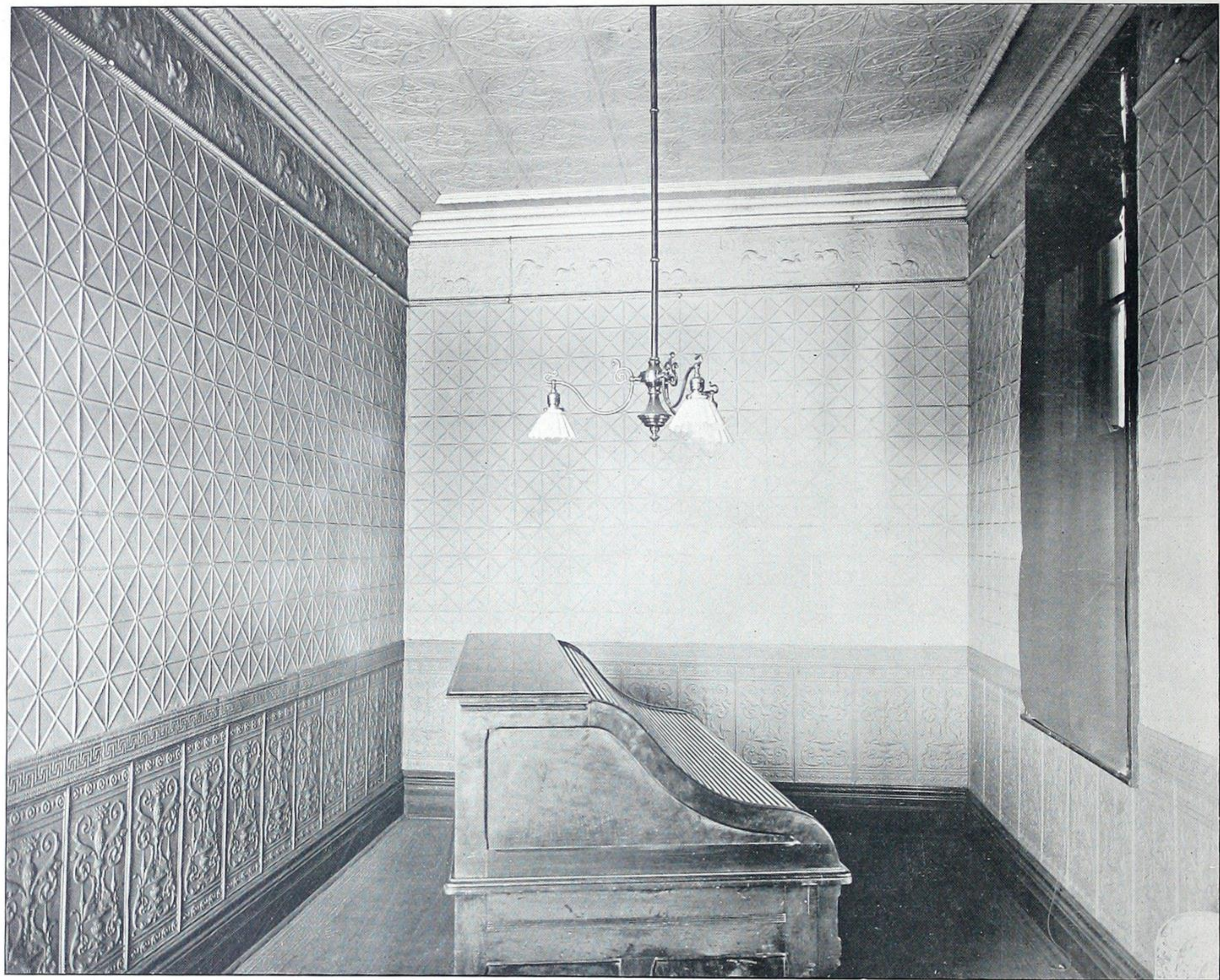

Fig. 3714.—Ceiling and Walls in Private Office, Polson Iron Works Co., Toronto.
Ceiling Plates No. 427; Moulding No. 920; Combined Cornice and Border No. 304; Frieze Nos. 807 and 808; Wall Plates No. 435; Dado Capping No. 923; and Dado Plates No. 457. Reproduced from a photograph.

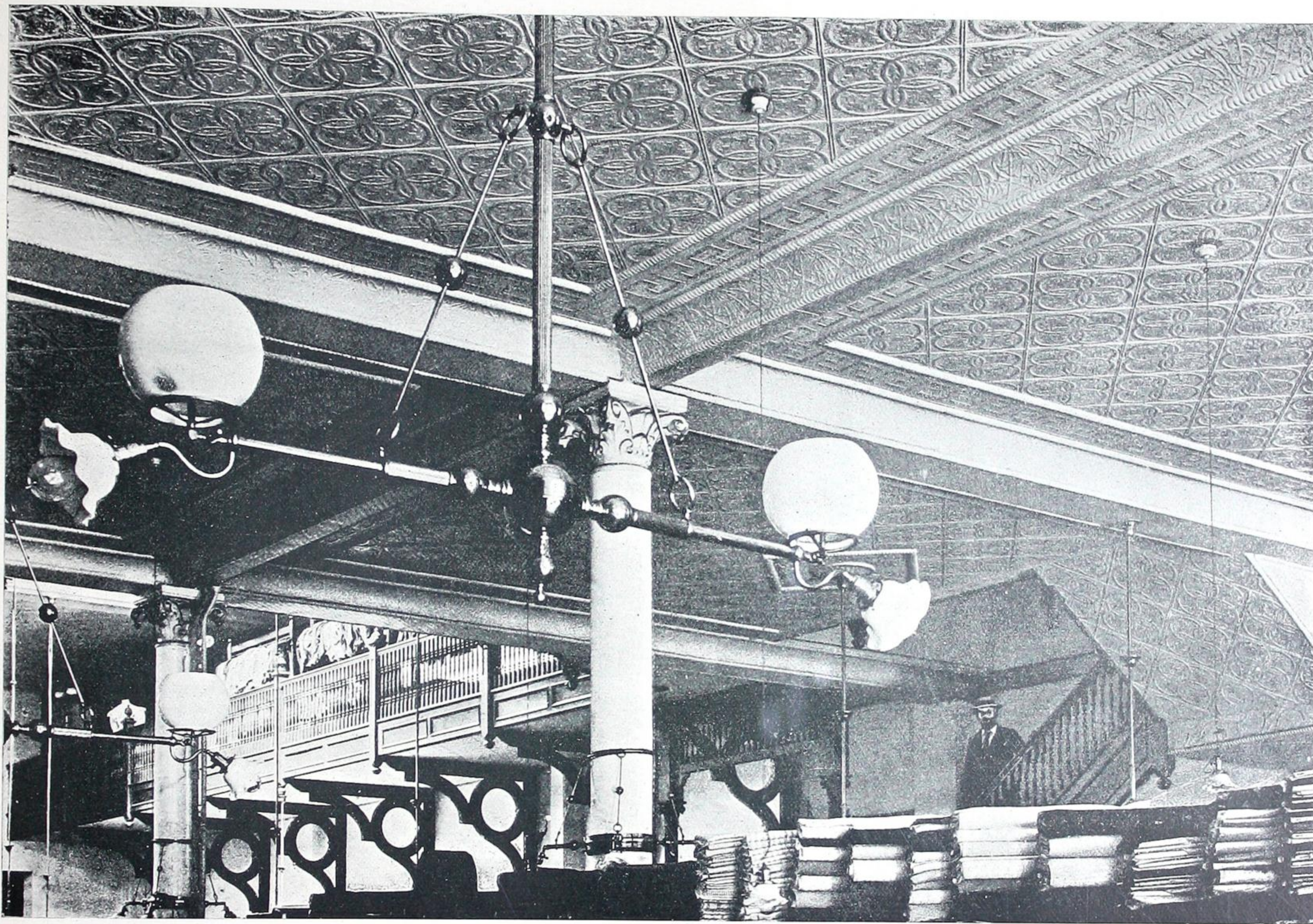

Fig. 3715.

Ceiling Composed of Field Plates No. 426; Mouldings No. 917; Border No. 802, and Cornice No. 302. Reproduced from a photograph.



Fig. 3716.

Ceiling in W. R. Brock & Co.'s Warehouse, Toronto.

Field Plates No. 481; Cornice No. 303; Cornice at Beam No. 305. Reproduced from a photograph.

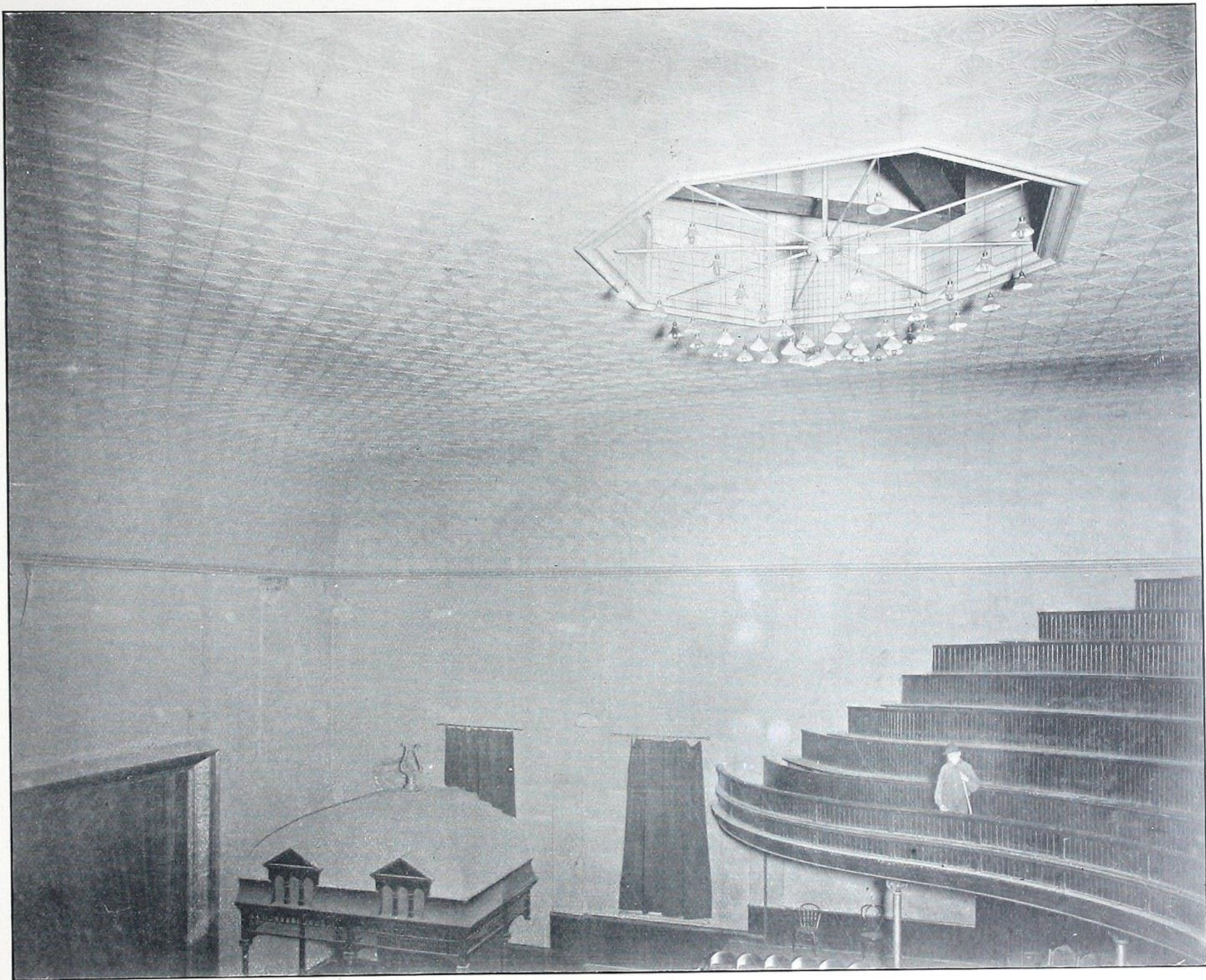

Fig. 3717.

Ceiling in Princess Theatre, Toronto.

Field Plates No. 430; Foot Moulding No. 910. Reproduced from a photograph.

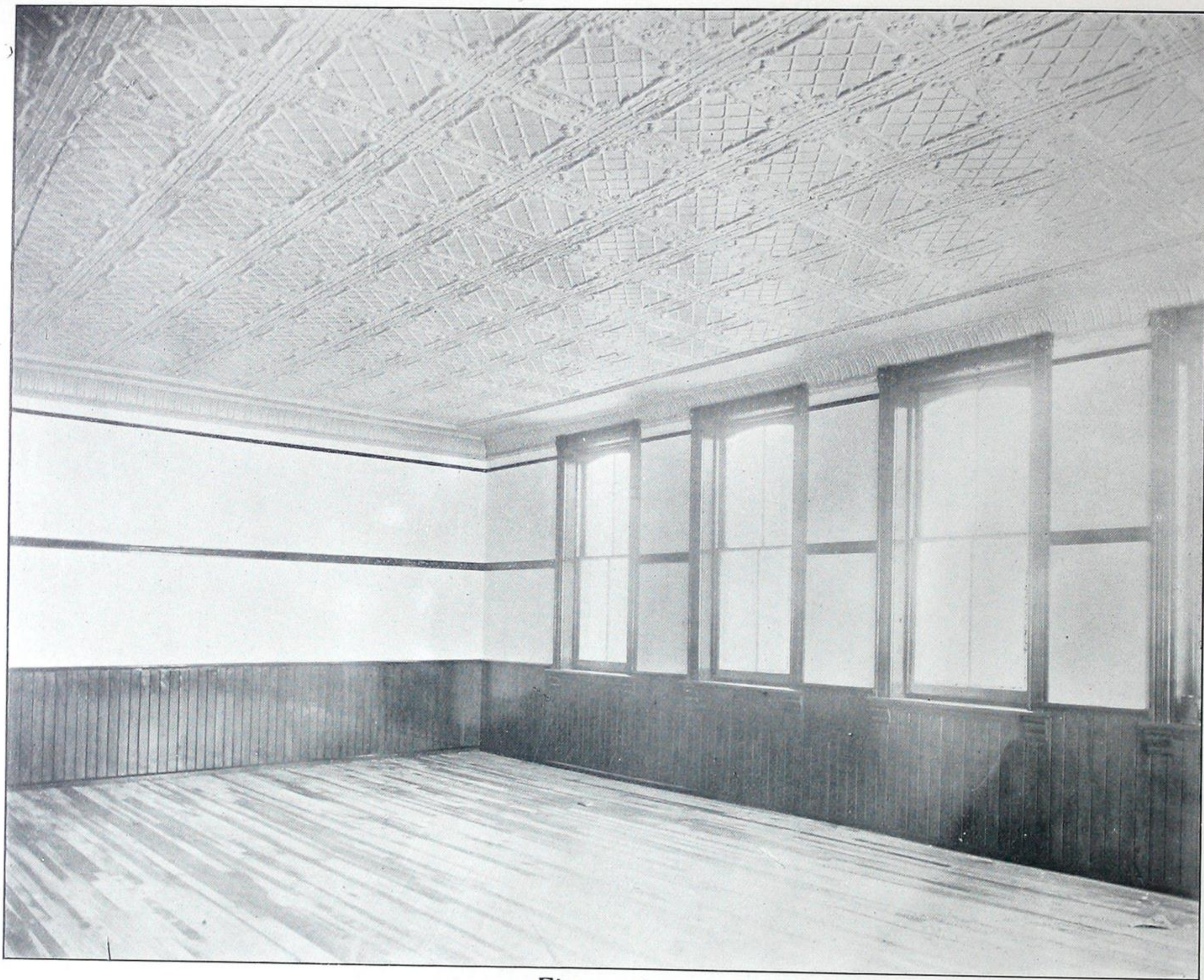

Fig. 3718.

Ceiling in Class Room, Queen Victoria School, Toronto.

Field Plates No. 444; Mouldings No. 920; Border No. 812; and Cornice No. 302. Reproduced from a photograph.

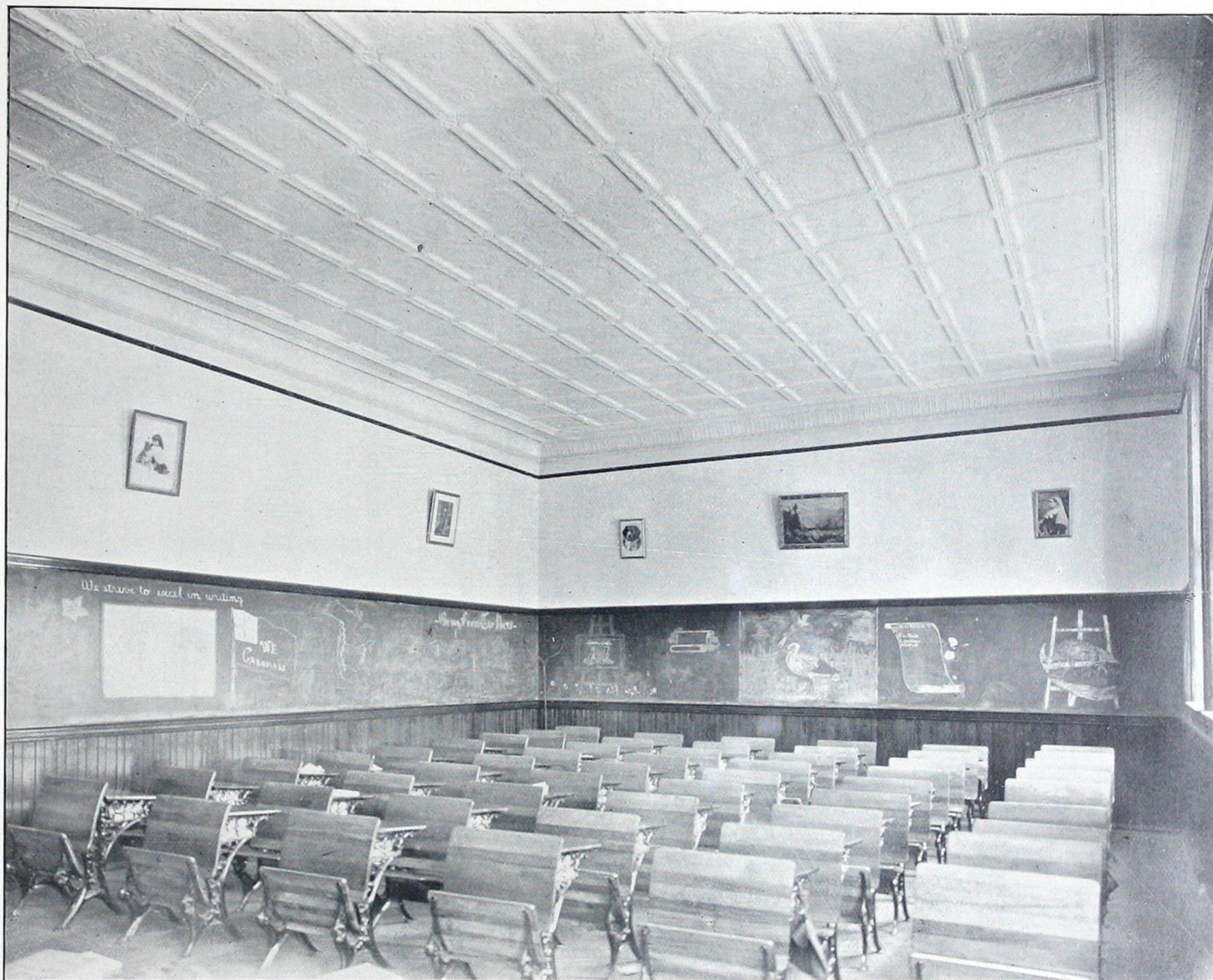

Fig. 3719.

Ceiling in Class Room of Dewson Street School, Toronto.

Field Plates No. 401; Moulding No. 920; Border No. 812; and Cornice No. 302. Reproduced from a photograph.

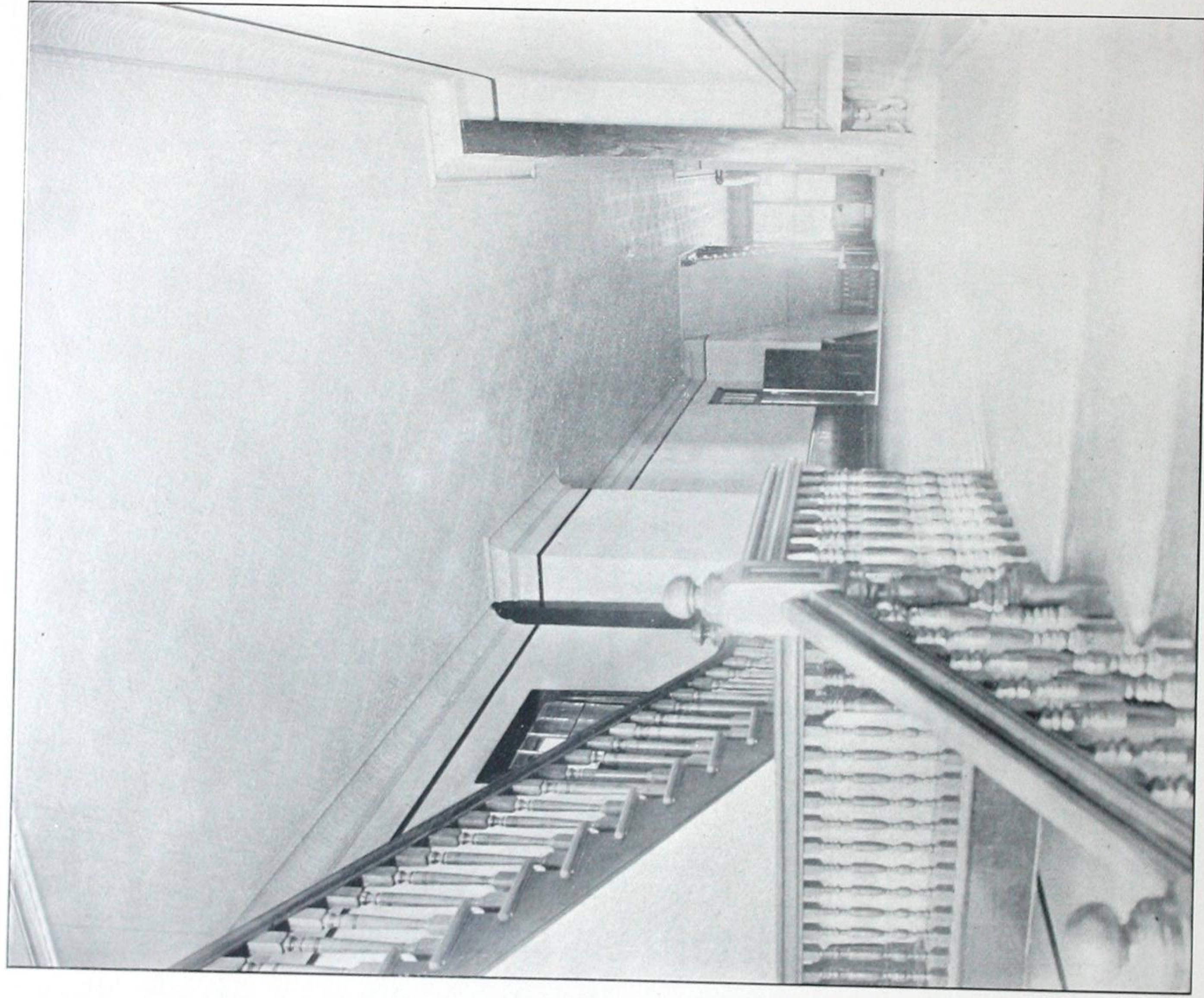

Fig. 3720.

Ceiling in Corridors of Dewson Street School, Toronto.
Field Plates No. 429; Moulding No. 920, and Cornice No. 302. Reproduced from a photograph.

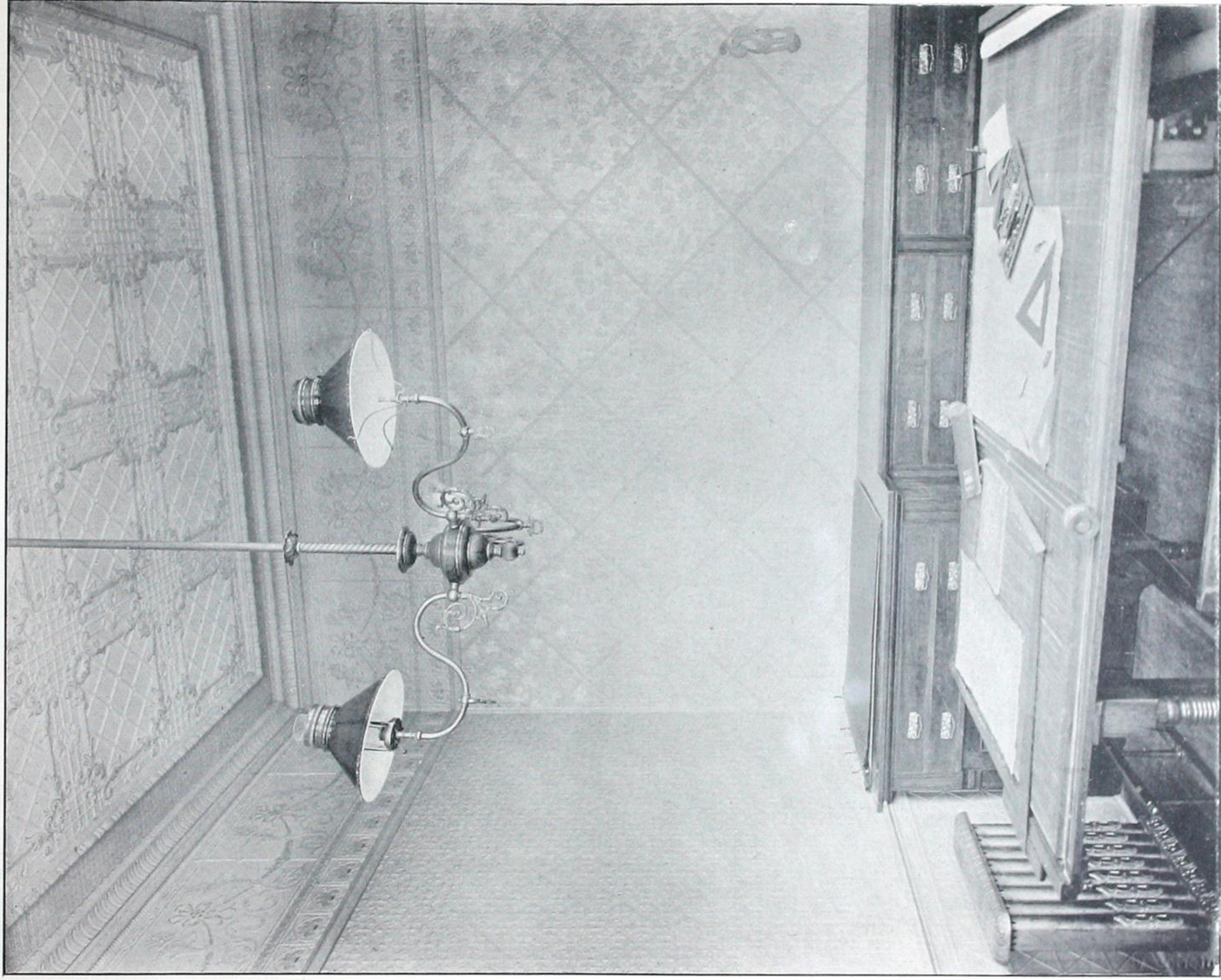

Fig. 3721.

Section of Ceiling and Walls in Draughting Room, Metallic Roofing Co.

Ceiling Plates No. 444; Moulding No. 920; Cornice and Border No. 394; Frieze No. 446; Wall Plates Nos. 425 and 812 (No. 425 laid diagonally); Special Dado Cap, and Plates No. 435 used for Dado. Reproduced from a photograph.

THE METALLIC ROOFING COMPANY OF CANADA, LIMITED, TORONTO, CANADA.



Fig. 3722.

Interior view in our General Office, corner King and Dufferin Streets, Toronto. Reproduced from a photograph.

THE METALLIC ROOFING COMPANY OF CANADA, LIMITED, TORONTO, CANADA.



Fig. 3723.

Interior view Manager's Private Office, Metallic Roofing Company. Reproduced from a photograph.



Fig. 3724.

Ceiling and Walls in Dining Room in residence of E. V. Ransford, Esq., Toronto.
Plates No. 417; Border No. 802; Mouldings No. 920; Cove No. 302; Frieze Nos. 807 and 808; Wall No. 418. Reproduced from a photograph.

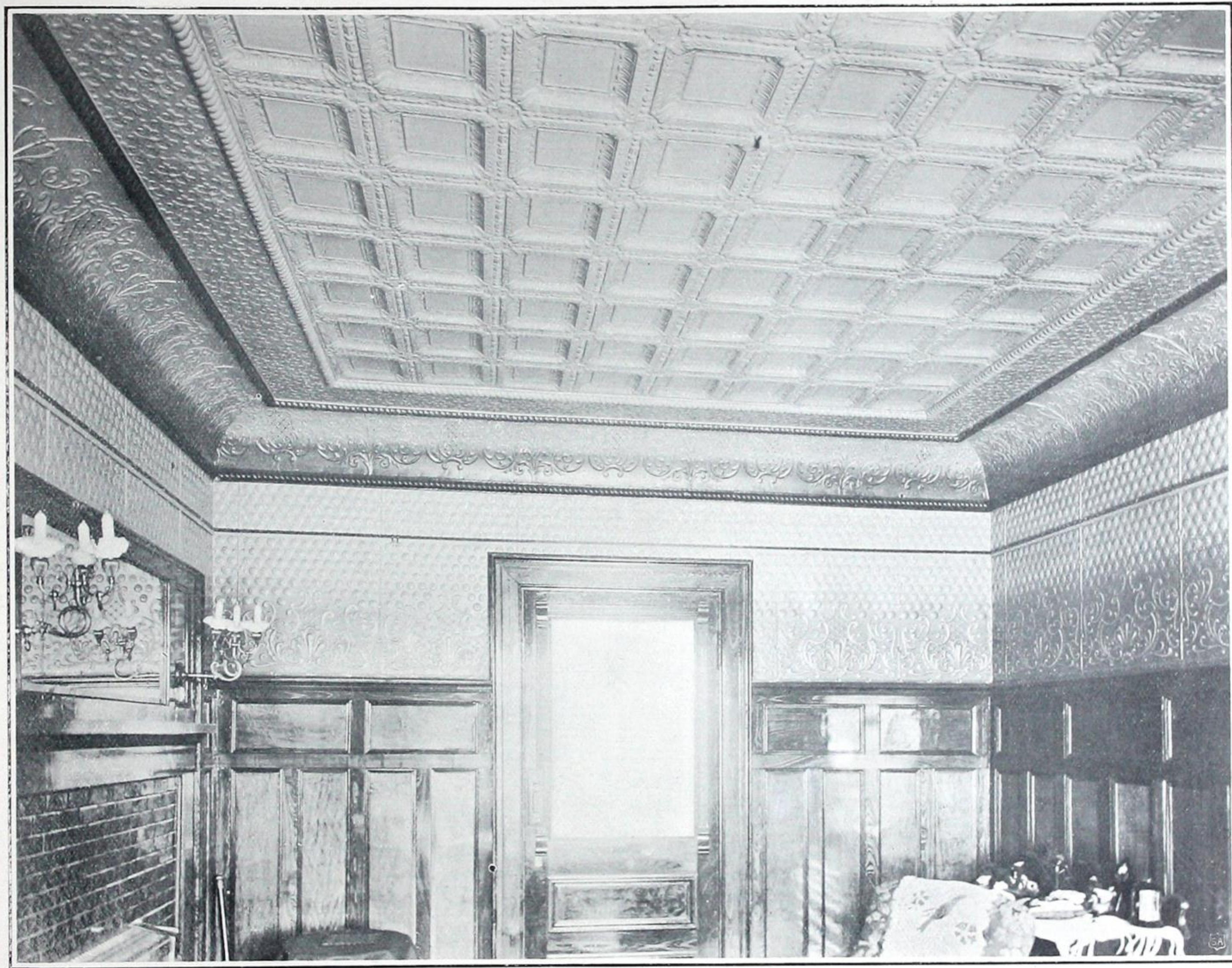

Fig. 3725.

Ceiling and Frieze in Library of residence of E. V. Ransford, Esq., Toronto.

Plates No. 403; Border No. 812; Moulding No. 918; Cove No. 339; Frieze No. 815, thirty inches deep. Reproduced from a photograph.

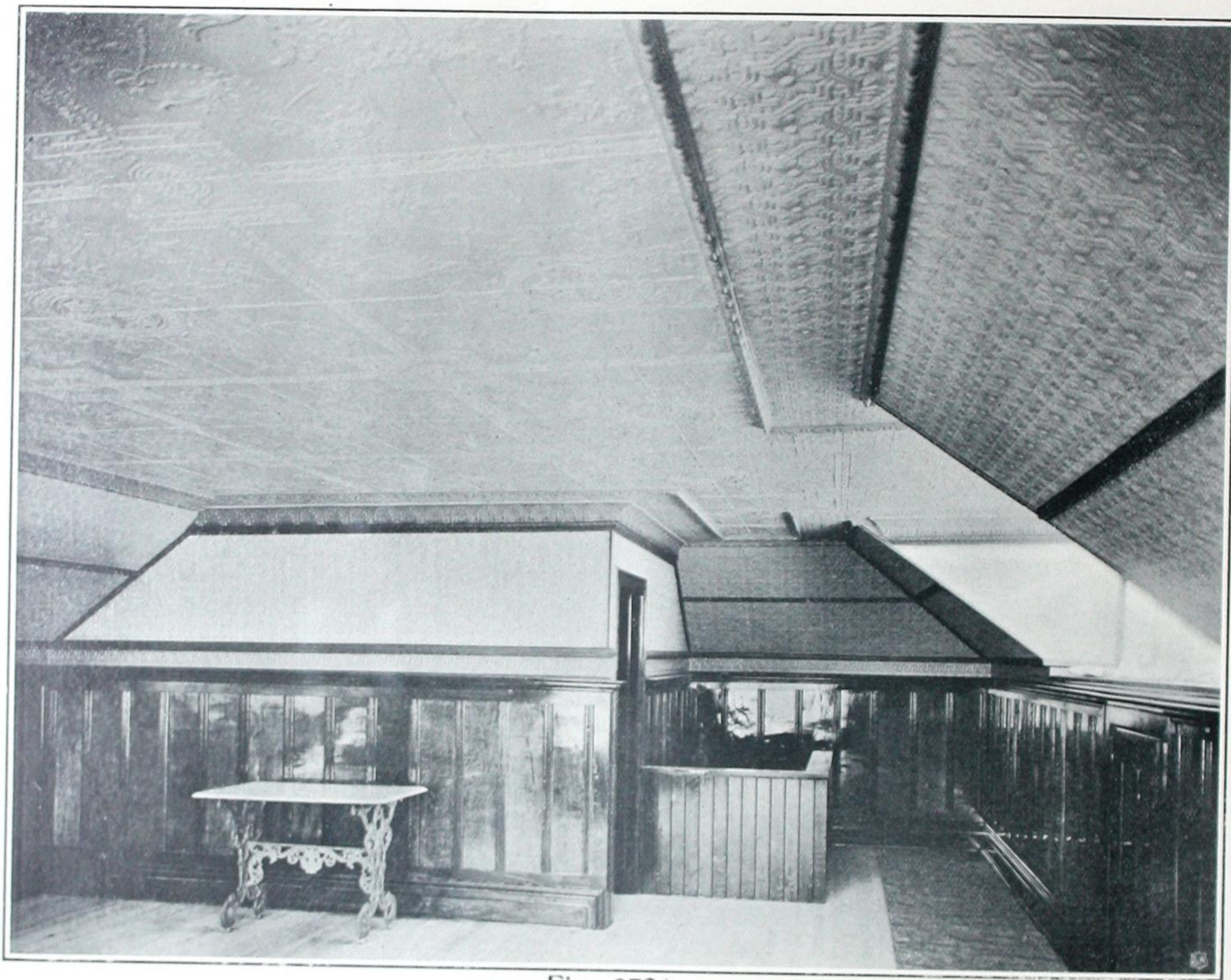

Fig. 3726.

Ceiling and Walls in Billiard Room of residence of E. V. Ransford, Esq., Toronto.
Plates No. 445; Border No. 814; Moulding No. 920; Cornice No. 337; Walls No. 814; Dado Capping No. 923. Reproduced from a photograph.



Fig. 3727.

Ceiling and Walls in Hall of residence of E. V. Ransford, Esq., Toronto.

Ceiling Plates No. 444; Border No. 812; Moulding No. 921; Cornice No. 339; Walls No. 422. Reproduced from a photograph.



Fig. 3728.

Ceiling and Walls in Kitchen of residence of E. V. Ransford, Esq., Toronto.

Ceiling Plates No. 426; Border No. 802; Moulding No. 920; Cornice No. 337; Walls No. 436;
Dado No. 435. Reproduced from a photograph.

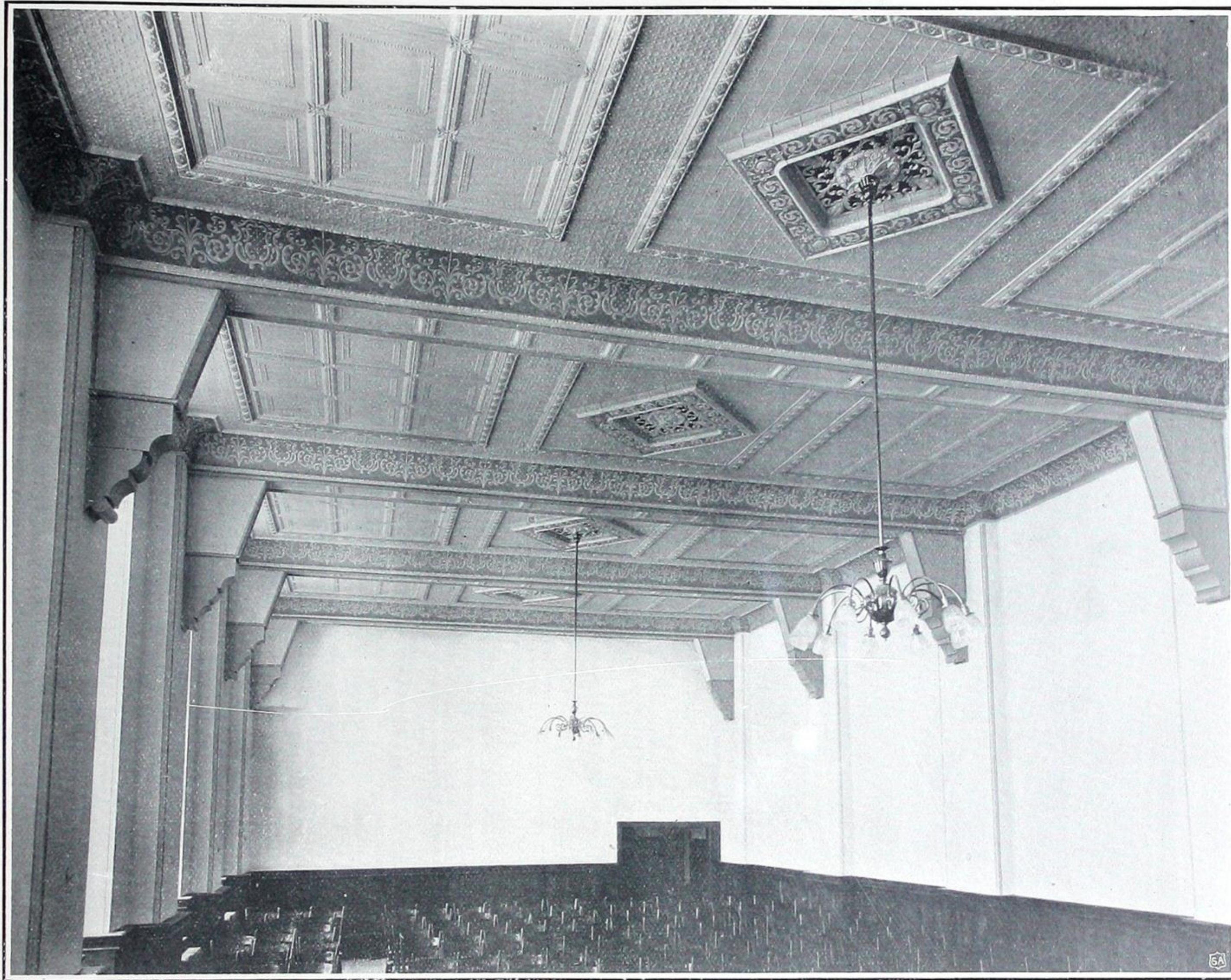

Fig. 3729.—Ceiling in Council Chamber, Salvation Army Temple, Toronto.

Cove No. 339; Border No. 812; Moulding No. 915; Side Panels, Plates No. 411; Centre Panels, Ventilating Centres No. 710 and Plates No. 436.
Reproduced from a photograph.

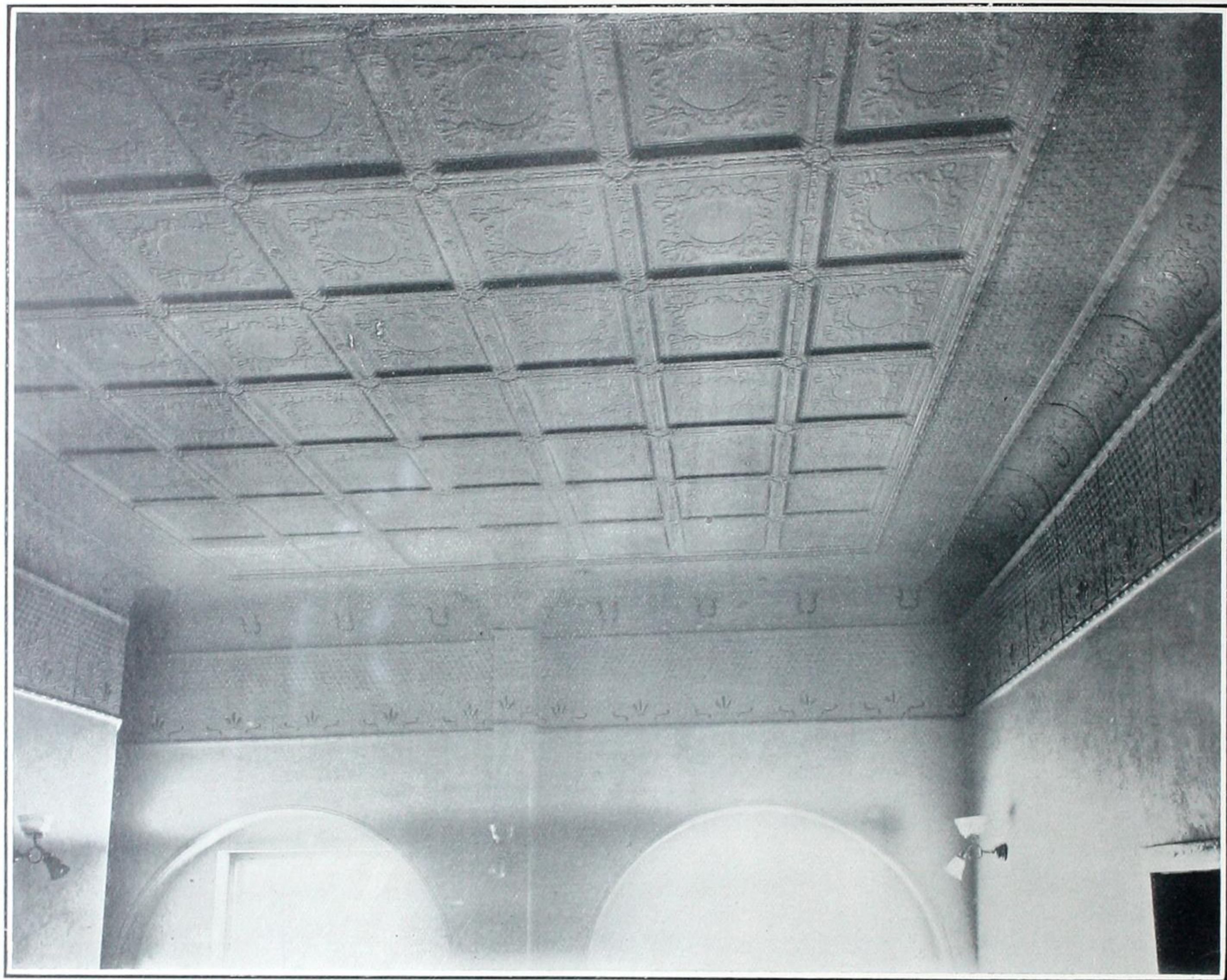

Fig. 3730.

Ceiling in Board Room, Salvation Army Temple, Toronto.

Plates No. 401; Border No. 812; Moulding No 920; Cove No. 339; Frieze No. 815.



Fig. 194.—Mansion House, Cape Town, South Africa,
In which our Embossed Metal Ceilings are used throughout.

Steel Ceiling.



Fig. 195.

Hiscox Building, London,

In which our Embossed Steel Ceilings are used.

McBride & Farncombe, Architects.

GALVANIZED STEEL EAVETROUGHS.

Made from the very finest quality of galvanized steel; 26 or 28 gauge. The designs shown are our regular stock patterns, but we can furnish to order, eavetrough made to any detail required, either straight, or curved to any radius. We also make copper eavetrough to any shape required.

O. G. Eavetrough.



Fig. 196.

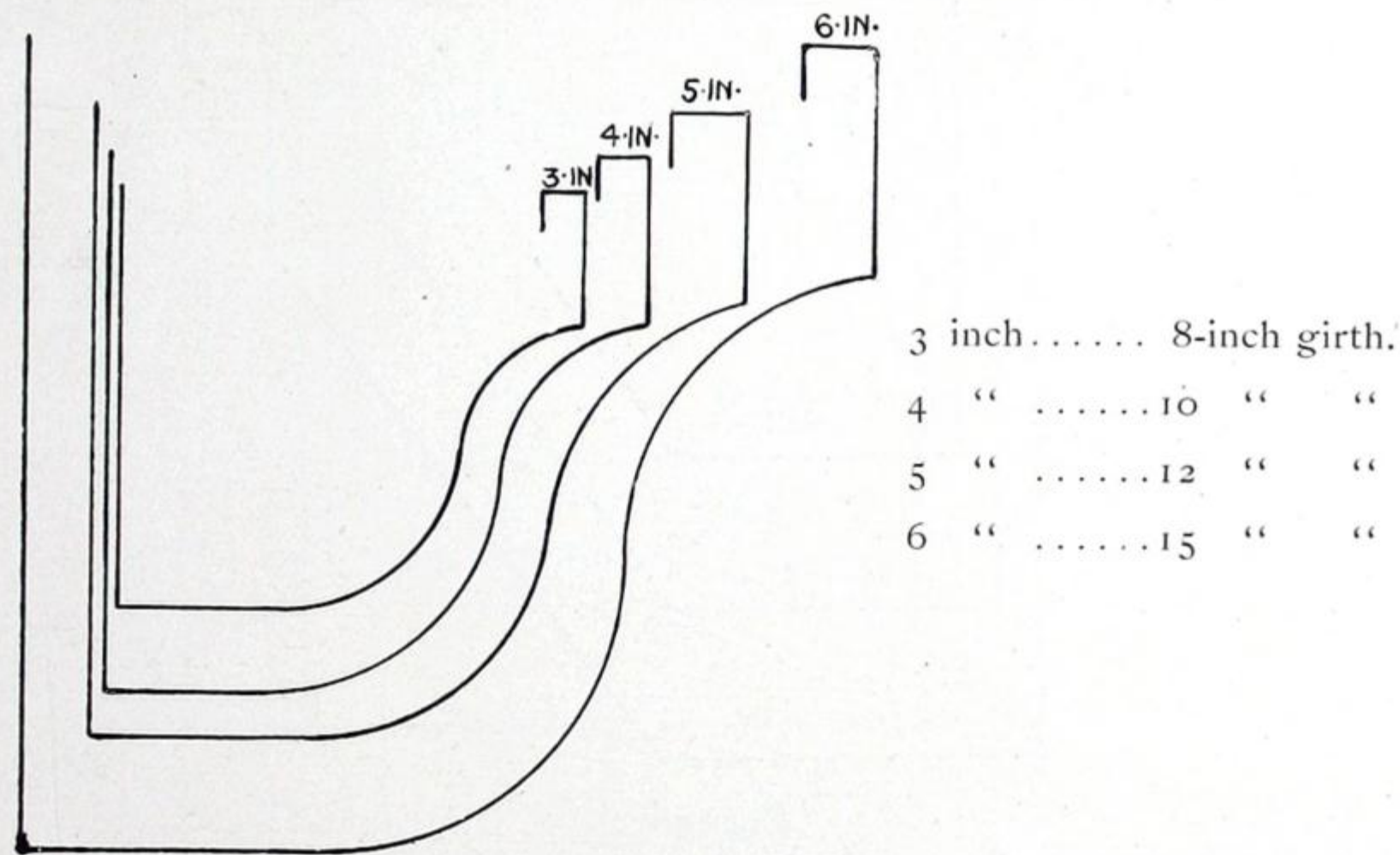

Fig. 197.

Pattern of our O. G. Eavetrough. One-half actual size.

O. G. High-Back Eavetrough.

Same shape as regular O. G. trough, as shown in Fig. 196, except back is higher.

4 inch	12-inch girth.
5 "	15 " "
6 "	18 " "

Half-Round Eavetrough.



Fig. 198.

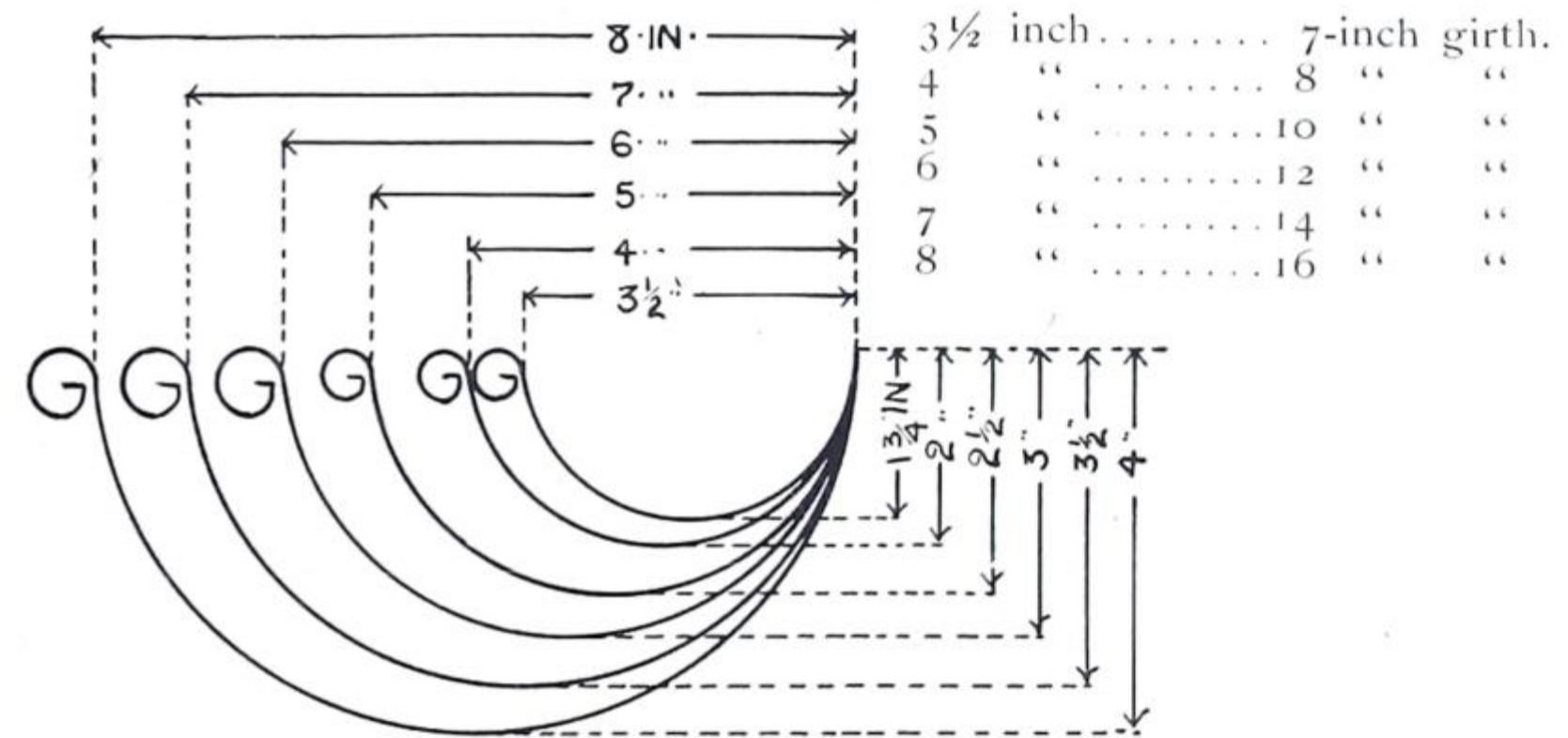

Fig. 199.

Pattern of our Half-round Eavetrough. One-half actual size.

Style "A" Eavetrough.



Fig. 200.

10, 12 and 15-inch girth.

Style "B" Eavetrough.



Fig. 202.

10, 12 and 15-inch girth.

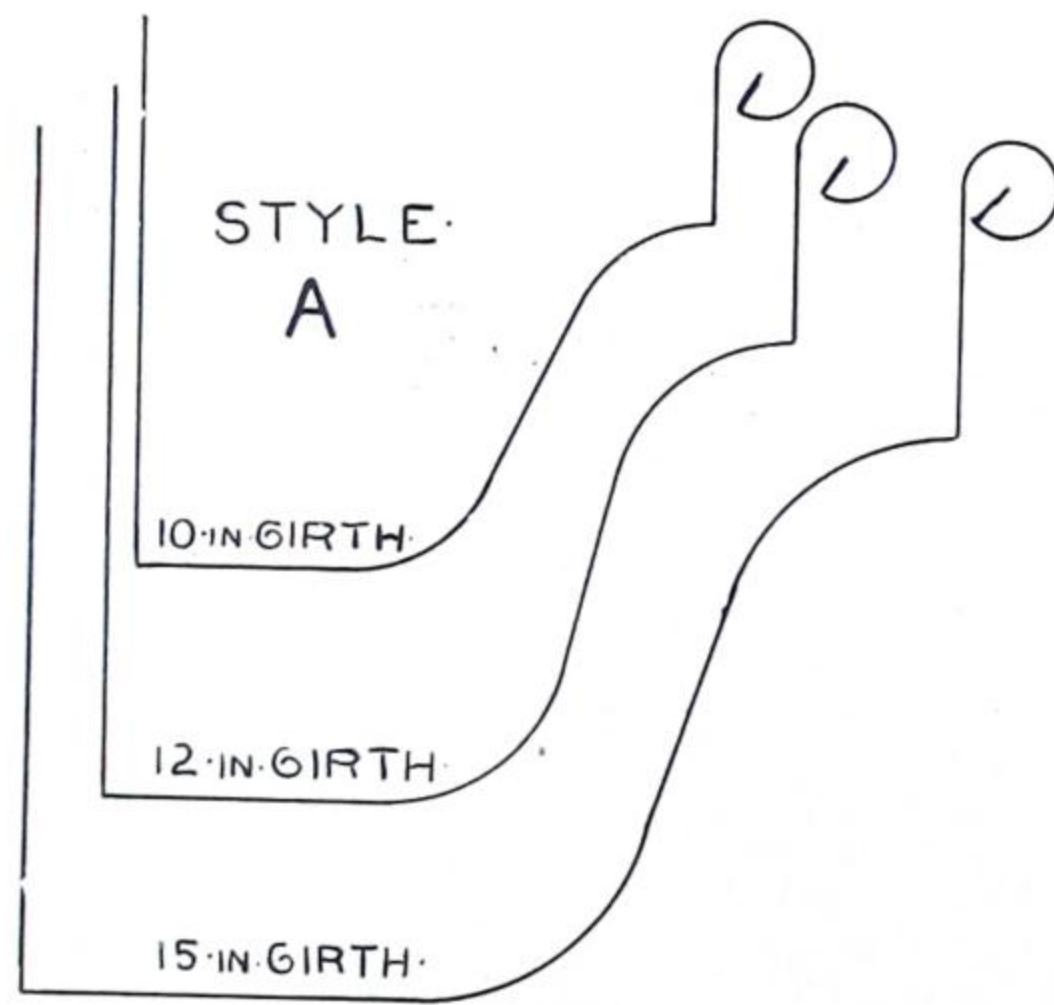

Fig. 201.

Pattern of our Style A Eavetrough. One-half actual size.

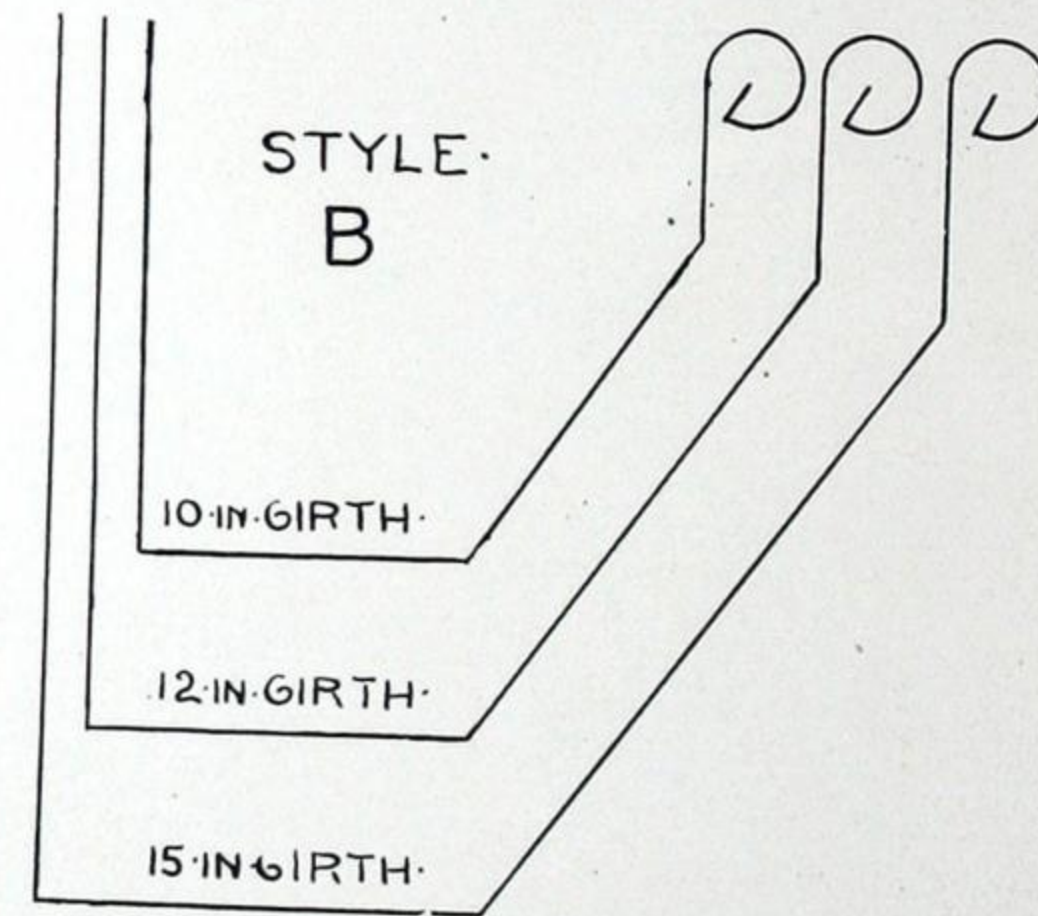

Fig. 203.

Pattern of our Style B Eavetrough. One-half actual size.

Style "C" Eavetrough.



Fig. 204.

10, 12 and 15-inch girth.

Style "D" Eavetrough.



Fig. 206.

15 and 18-inch girth.

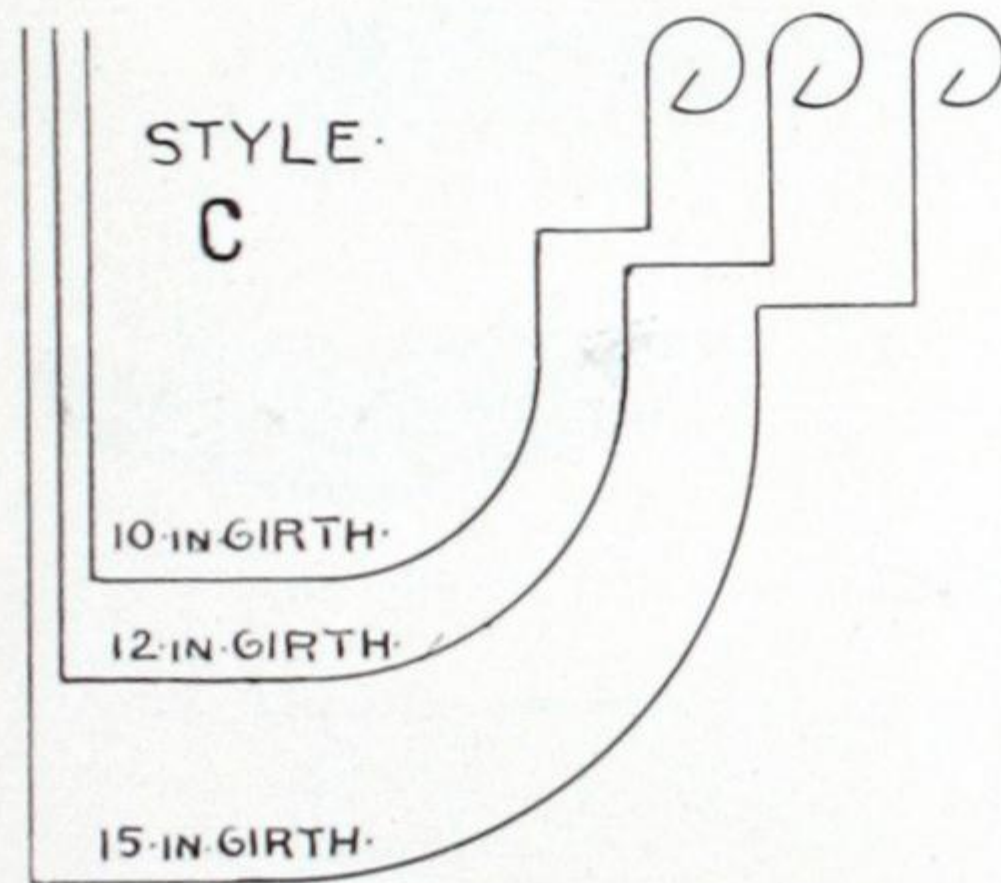

Fig. 205.

Pattern of our Style C Eavetrough. One-half actual size.

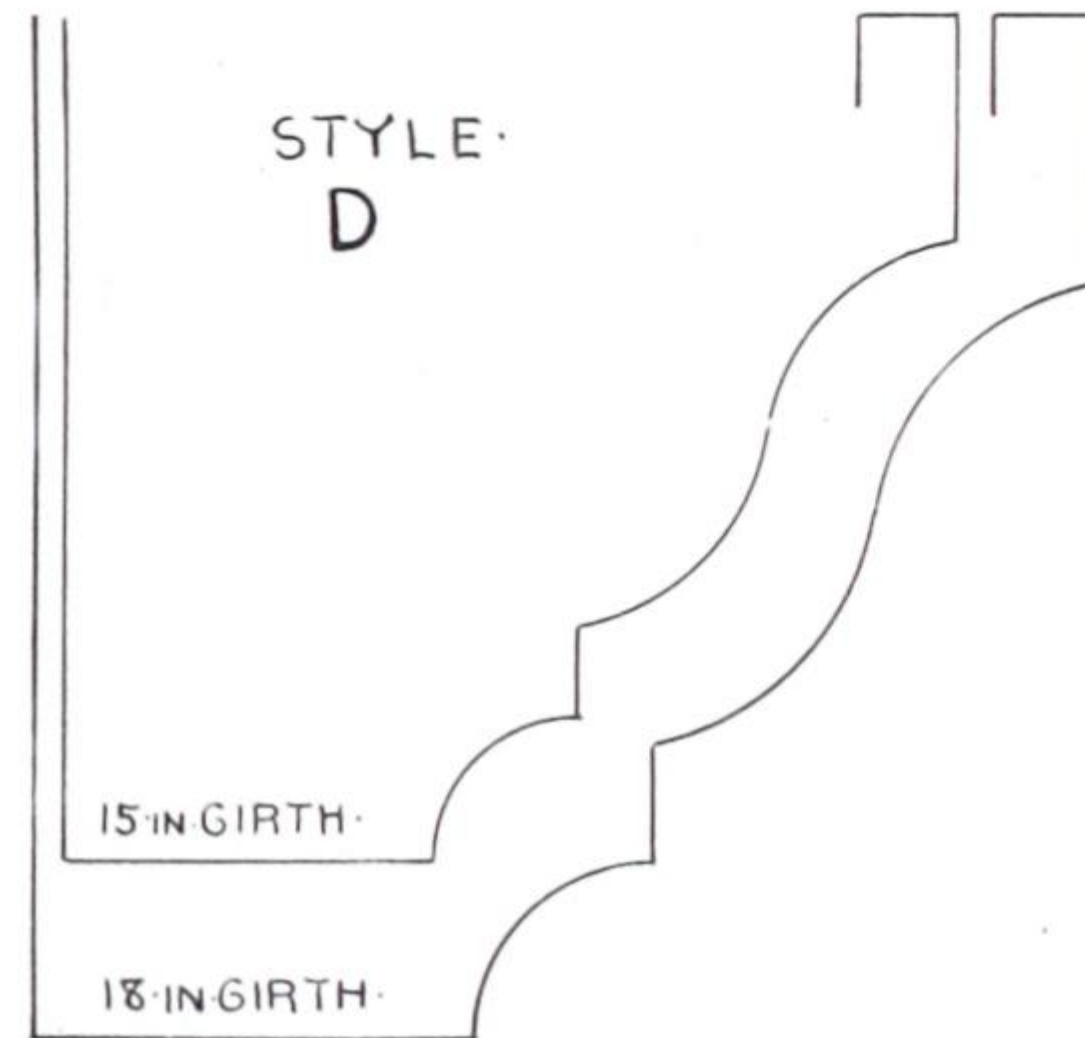

Fig. 207.

Pattern of our Style D Eavetrough. One-half actual size.

Style "E" Eavetrough.



Fig. 208.

10, 12 and 15-inch girth.

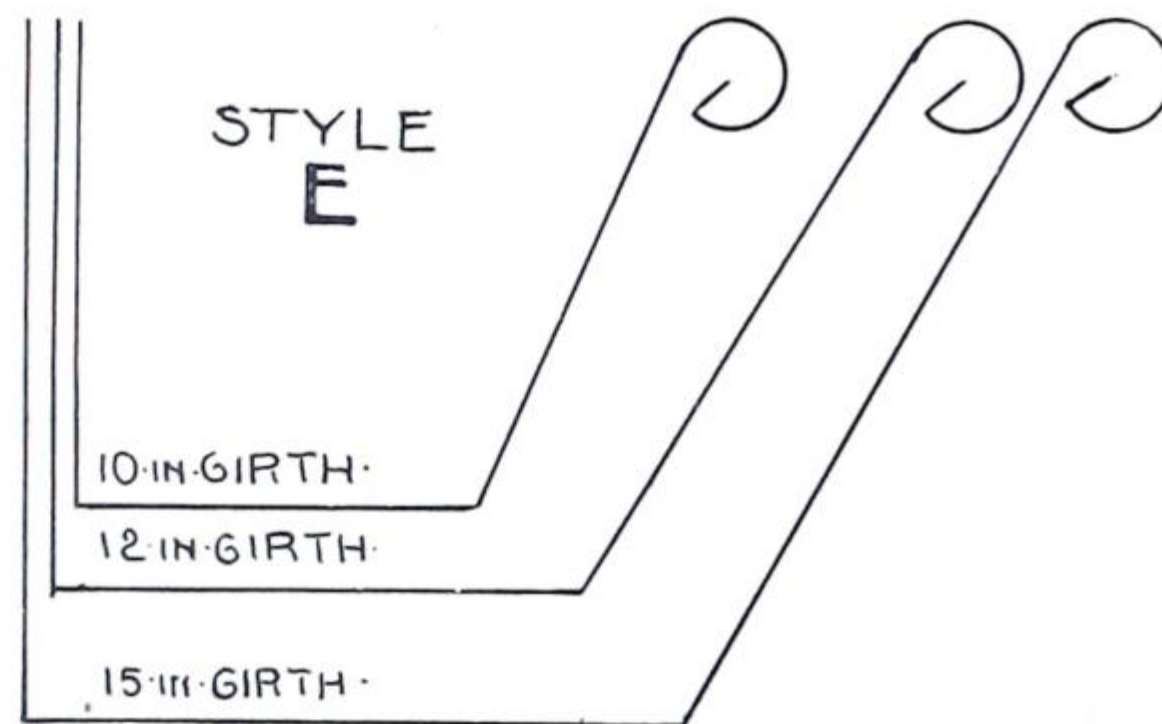

Fig. 209.

Pattern of our Style E Eavetrough. One-half actual size.

Eavetrough Mitres.

Mitres are not soldered together.



Fig. 210.

Shows an Inside Mitre.



Fig. 211.

Shows an Outside Mitre.

In ordering, always state whether inside or outside mitres are required.

THE METALLIC ROOFING COMPANY OF CANADA, LIMITED, TORONTO, CANADA.

Corrugated Expansion Conductor Pipe.



Fig. 212.

Five sizes, 2, 3, 4, 5, and 6-inch. Made in **10-ft. lengths** in one piece, without a cross seam, of No. 26 galvanized steel. This form of pipe, being corrugated, allows the metal to expand when filled with ice, without cracking or bursting.

Round Conductor Pipe.

LOCK SEAM.



Fig. 213.

Five sizes, 2, 3, 4, 5, and 6-inch. Made in **10-ft. lengths** in one piece, without a cross seam, of No. 26 galvanized steel.

Square Conductor Pipe.



Fig. 214.

Made in 26 or 28 gauge. Seam not soldered. Sizes, $1\frac{7}{8} \times 2\frac{3}{4}$ inch; $2\frac{1}{4} \times 3\frac{1}{4}$ inch; 3 x 4 inch; 4 x 4 inch.

Octagon Standing Seam Conductor Pipe.



Fig. 215.

Made from No. 26 galvanized steel in 8-ft. lengths.

The standing seam allows of an easy and secure fastening, keeping the pipe away from the wall, and will open in case of freezing, so as to prevent bursting or cracking of the pipe.

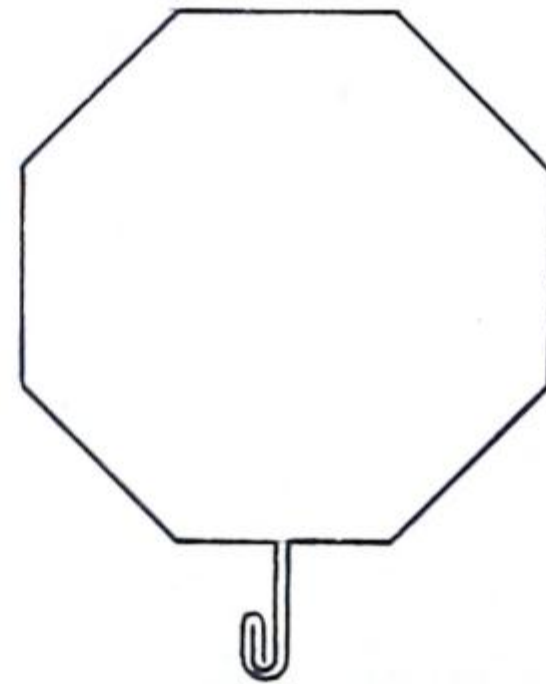

Fig. 216.

Size, 3	inch.....	12-inch	girth.
" 4	"	15	" "
" 5	"	18	" "
" 3 x 4	"	15	" "
" 4 x 5	"	18	" "

Section showing construction of our Octagon Standing Seam Conductor Pipe.

Corrugated Elbows and Shoes.

Made from one piece, flat crimped. Galvanized **after** being formed into shape.

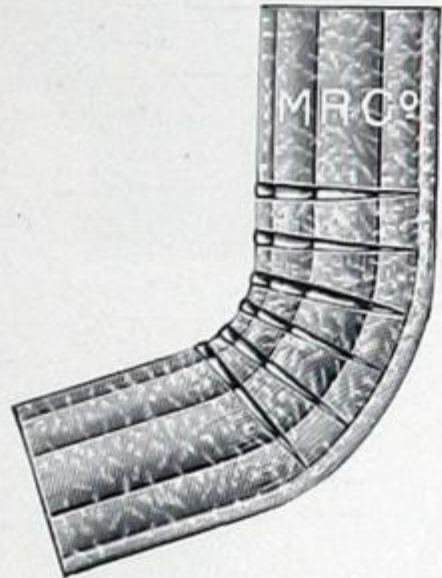

Fig. 217.
Corrugated Elbow.

Five sizes, 2, 3, 4, 5 and 6-inch.



Fig. 218.
Corrugated Shoe.

Round Elbows and Shoes.

Made from one piece, flat crimped. Galvanized after being formed into shape.

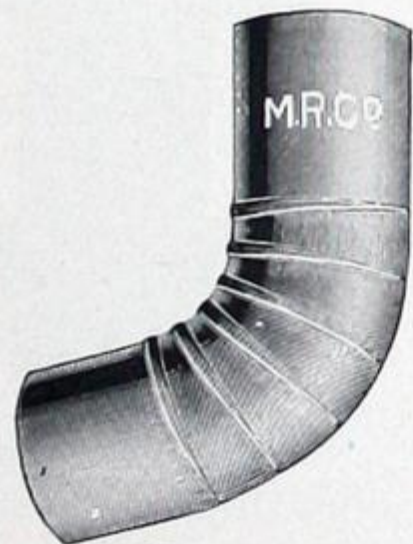

Fig. 219.
Round Elbow.

Five sizes, 2, 3, 4, 5, and 6-inch.



Fig. 220.
Round Shoe.

Conductor Hooks.

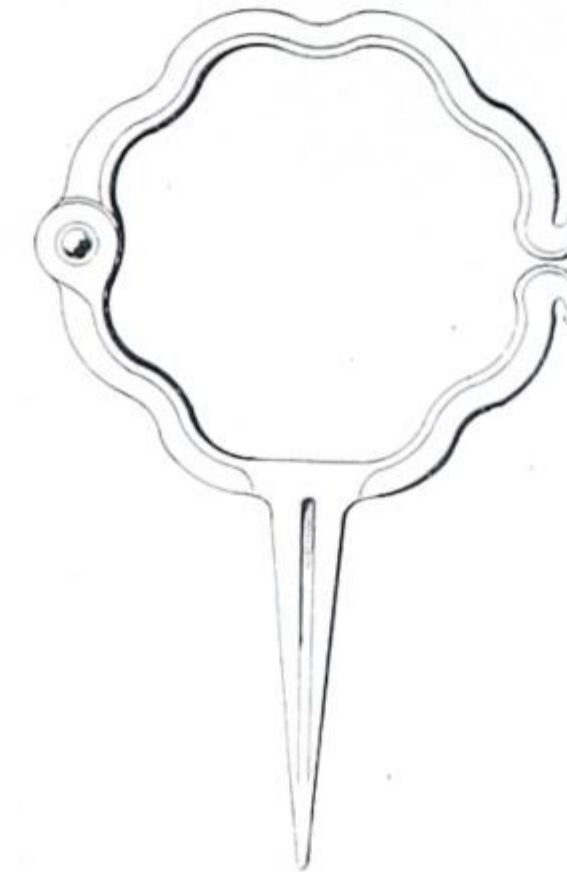

Fig. 221.

Corrugated Hinged Hooks.
Tinned malleable iron. 2, 3, 4, 5 and 6-inch.

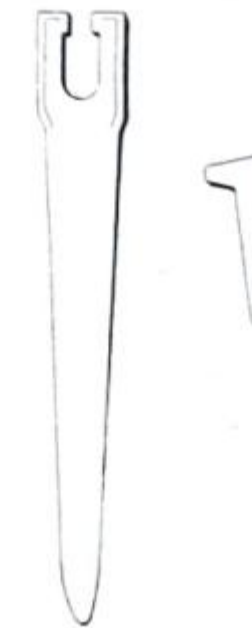
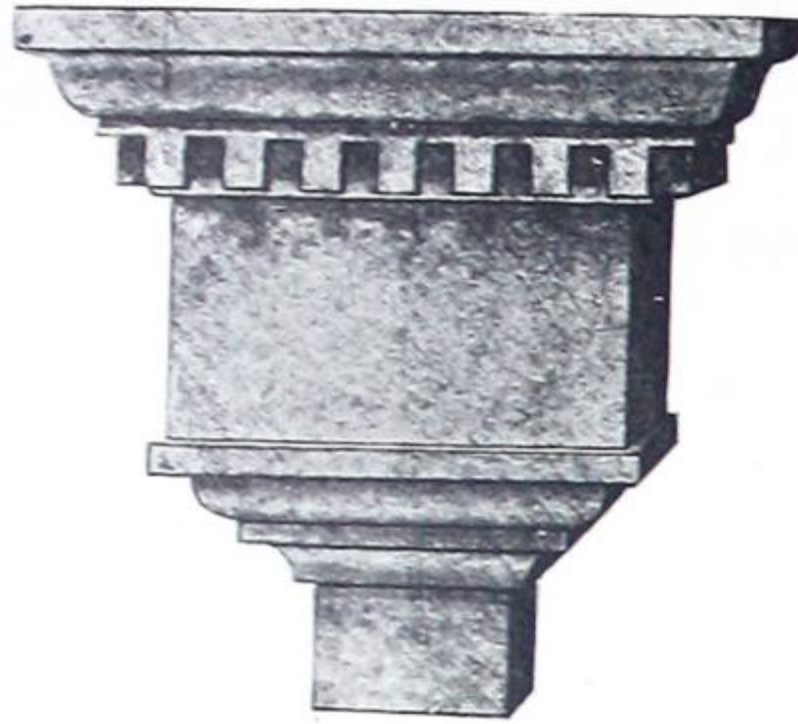

Fig. 222.

Holdfasts with wedge complete.
For Standing Seam Pipe. Malleable iron.
About six to a pound.

Ornamental Conductor Heads.

Made from Copper or Galvanized Steel.



No. 1014.



No. 1016.



No. 1019.



No. 1017.



No. 1020.

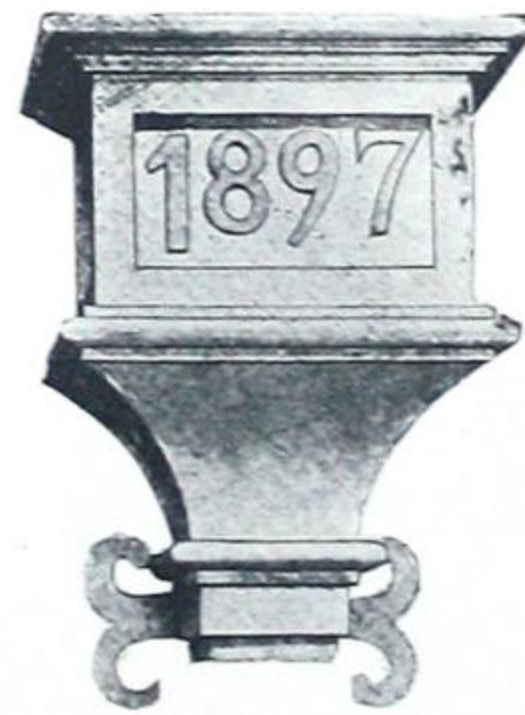

No. 1021.



No. 1018.

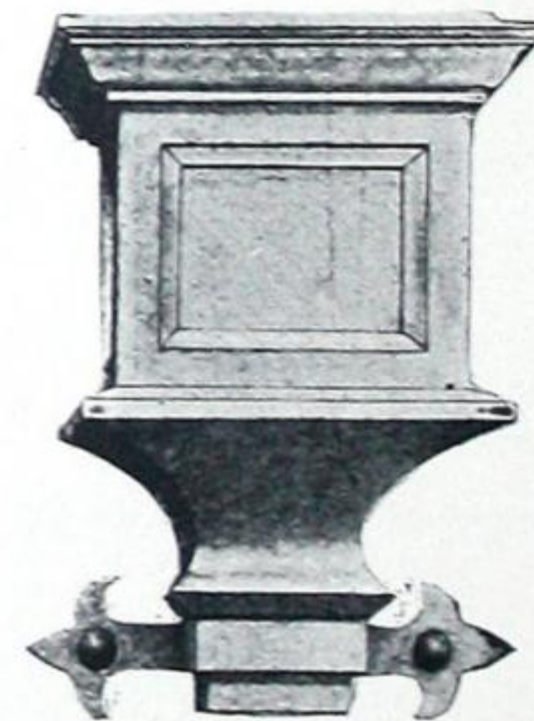

No. 1022.

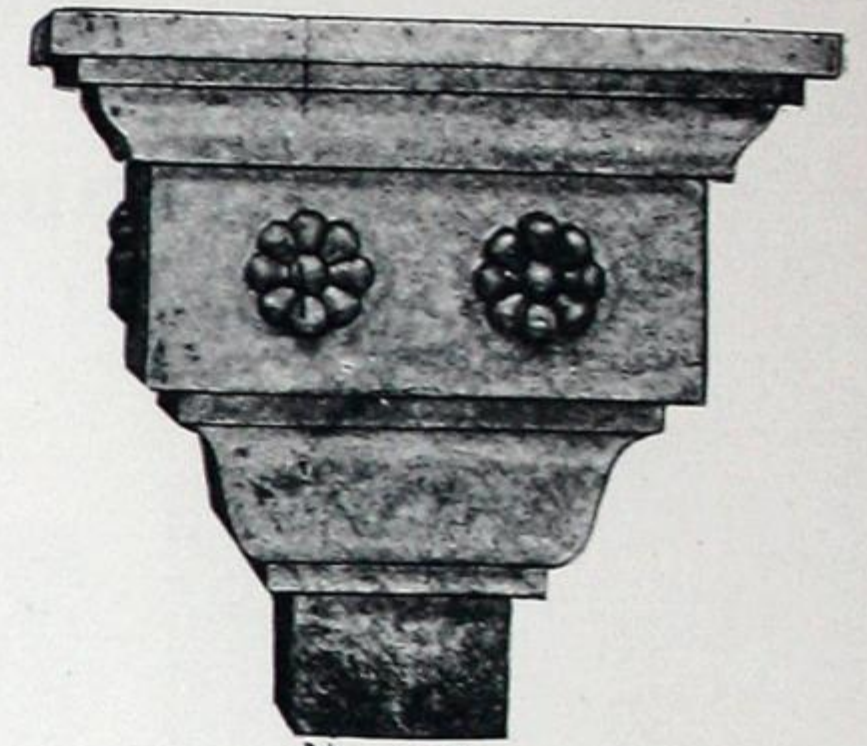

No. 1015.

No. 1023.

No. 1024.

No. 1025.

No. 1026.

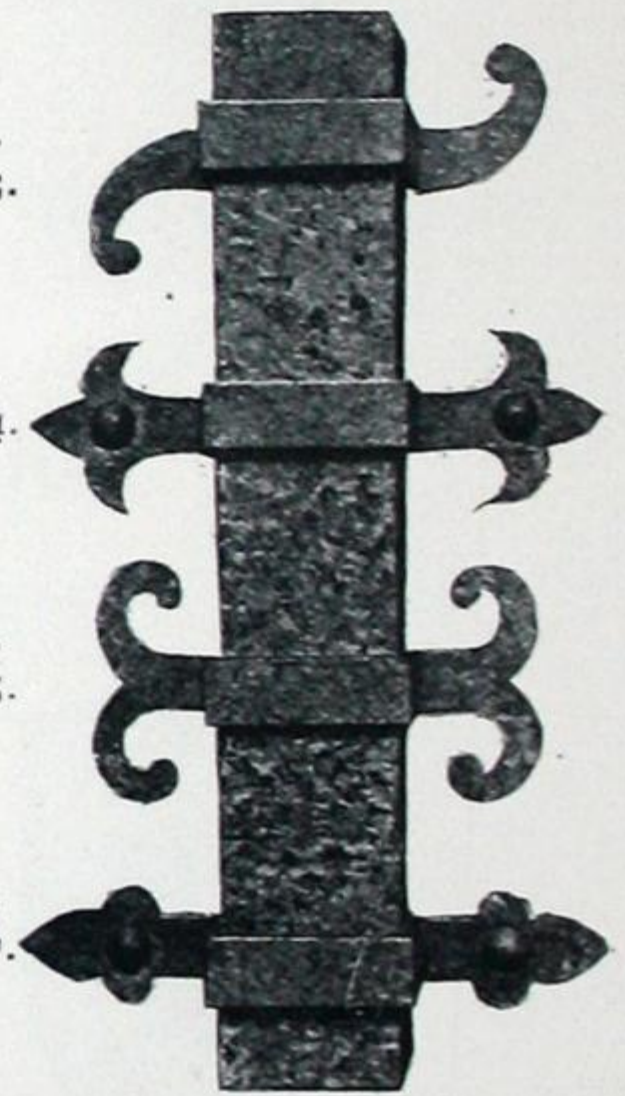

Fancy Conductor Straps, as applied to conductor pipe. Made from copper or galvanized steel.

Always order by number, and mention size and kind of conductor pipe to be used.

METALLIC SKYLIGHTS.



OUR SKYLIGHTS are made from either galvanized steel or from copper, so that they are practically fire-proof, particularly so when glazed with wire glass. They are infinitely preferable in every way to either wooden lights, or constructions where solid iron rafters are employed. Superior to the former inasmuch as there is **no contraction or expansion** to break the glass, or make leaks, there being only a small amount of metal used in the bar and frame to be acted upon by heat and cold. In all constructions where solid iron rafters are employed, where the glass is of necessity confined and held rigidly in place by means of a firm cement, the natural consequence in a great body of metal is the greater susceptibility to derangement by expansion in case of heat, this being relative to the actual quantity of metal employed; while by using a hollow bar of proper form, we arrive at the result of dispensing with the amount of solid matter, and preserving all of the original strength without its weight and liability to derangement.

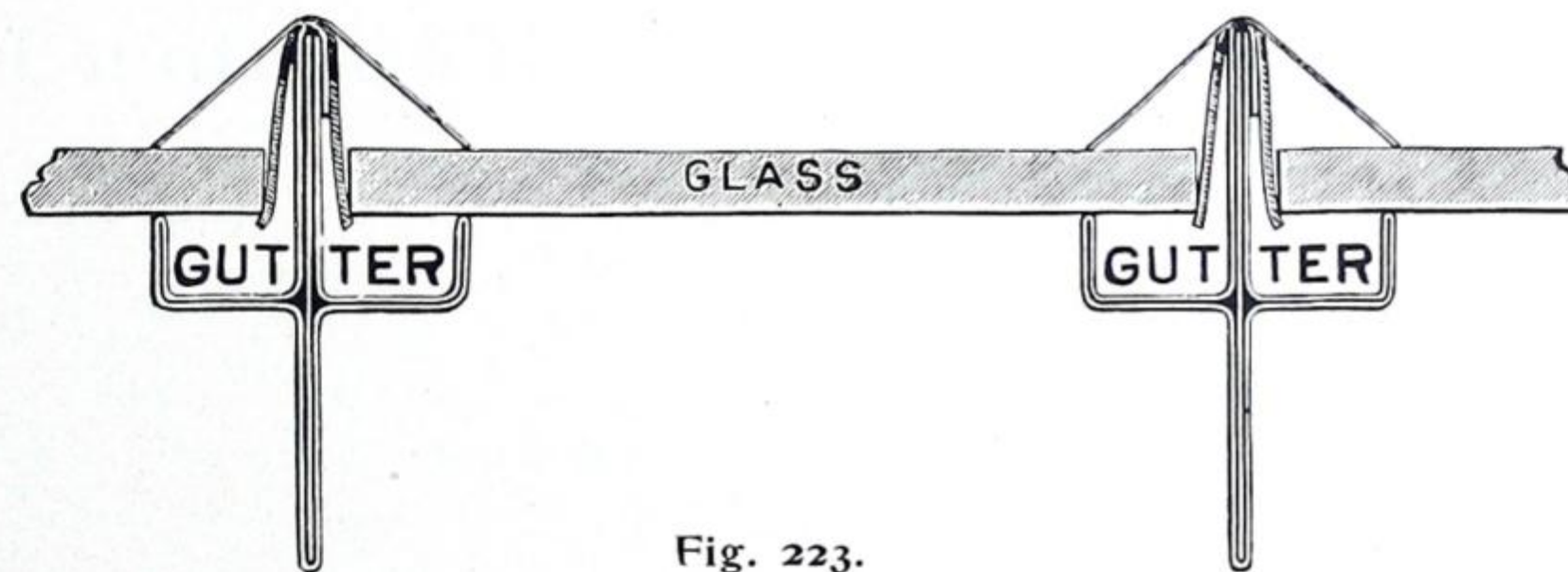
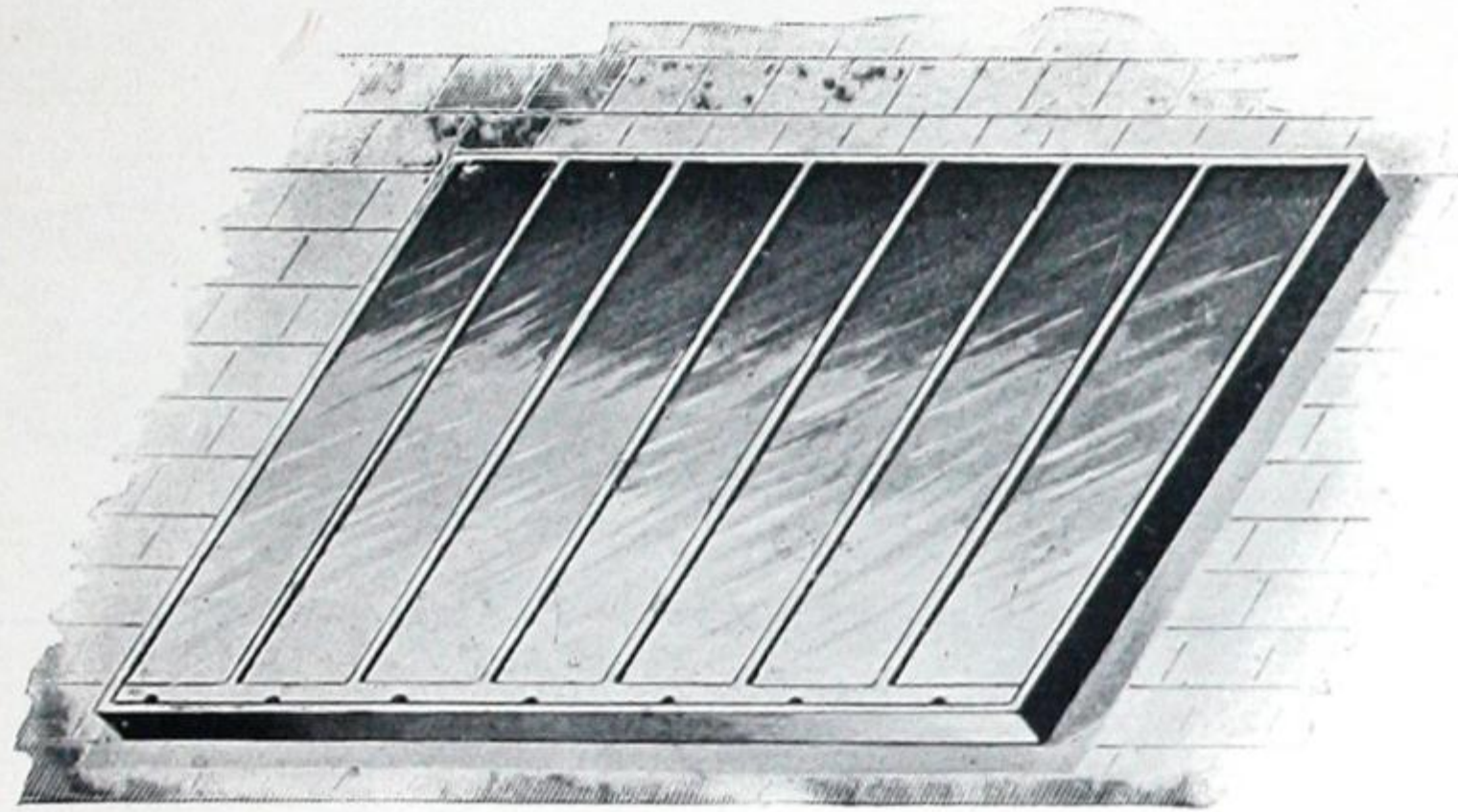

Fig. 223.

Represents the construction of the hollow bar, as used in our skylights, showing the glass in position with felt and cap complete. As will be seen, the bar is provided with a gutter running its entire length, which conducts all condensation on the under side of the glass down until it reaches the main gutter at the base of the skylight, and running into the latter is conducted outside on the roof, as illustrated in Fig. 224. This construction gives the advantage of looseness or play for the glass, without any detriment to the structure.

Metallic Skylights.



No. 1065.

Single-Pitch Skylight, showing application to pitch roof.

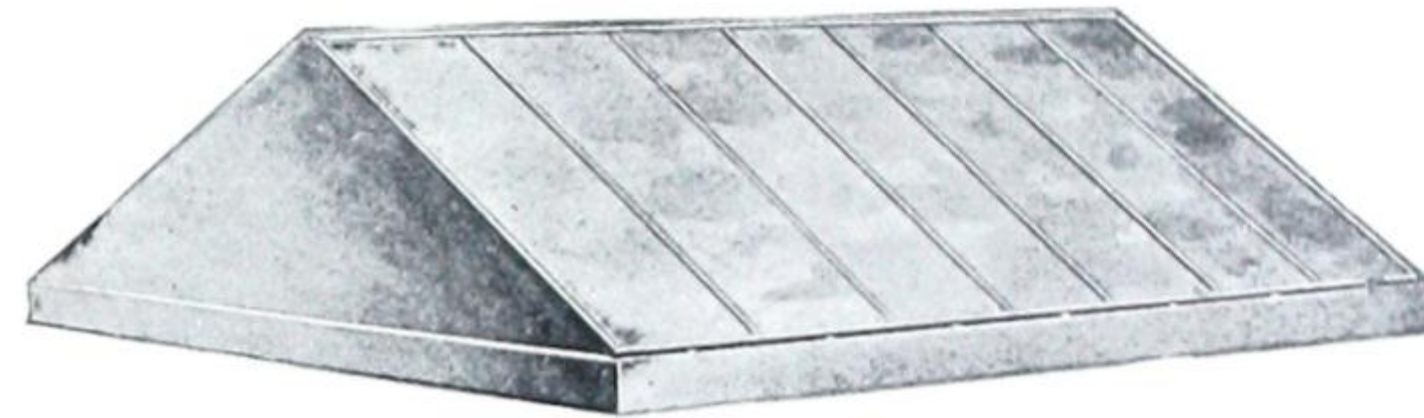

No. 1067.

Double-Pitch Skylight. Gable ends made of galvanized steel.

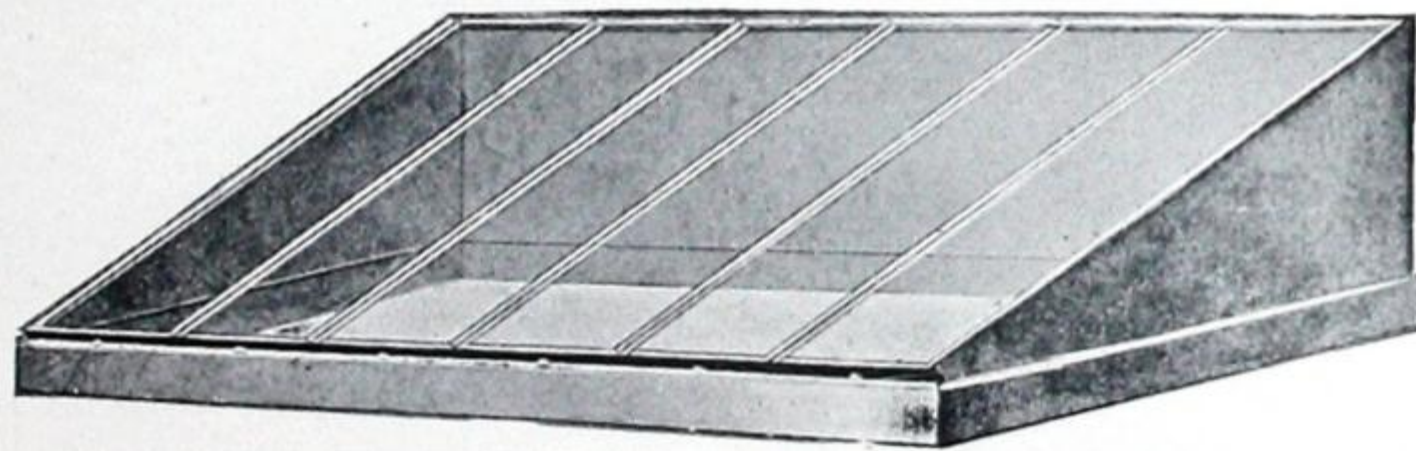

No. 1066.

Single-Pitch Skylight, as applied to flat roof. The pitch should be made in the wooden curb, except for small lights.

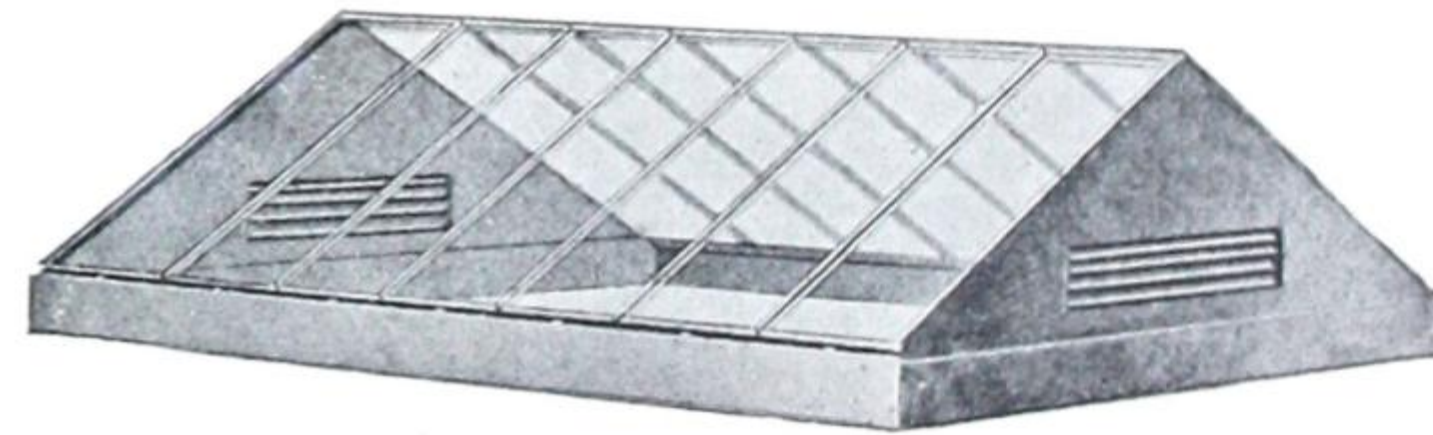

No. 1068.

Double-Pitch Skylight. Made with stationary or movable slats in gable ends, for ventilation.

Metallic Skylights.

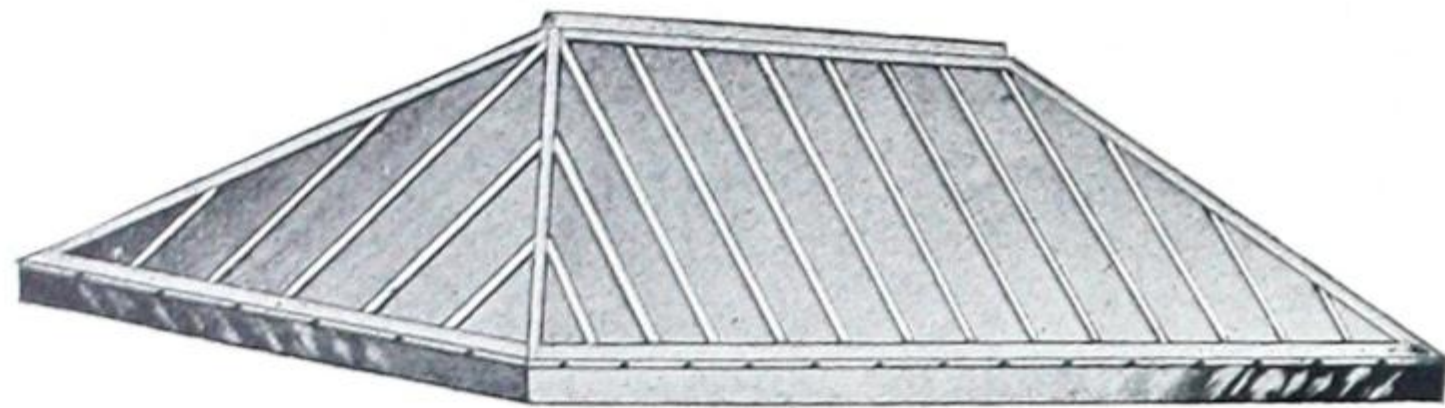

No. 1069.

Plain Hipped Skylight, without ventilator.

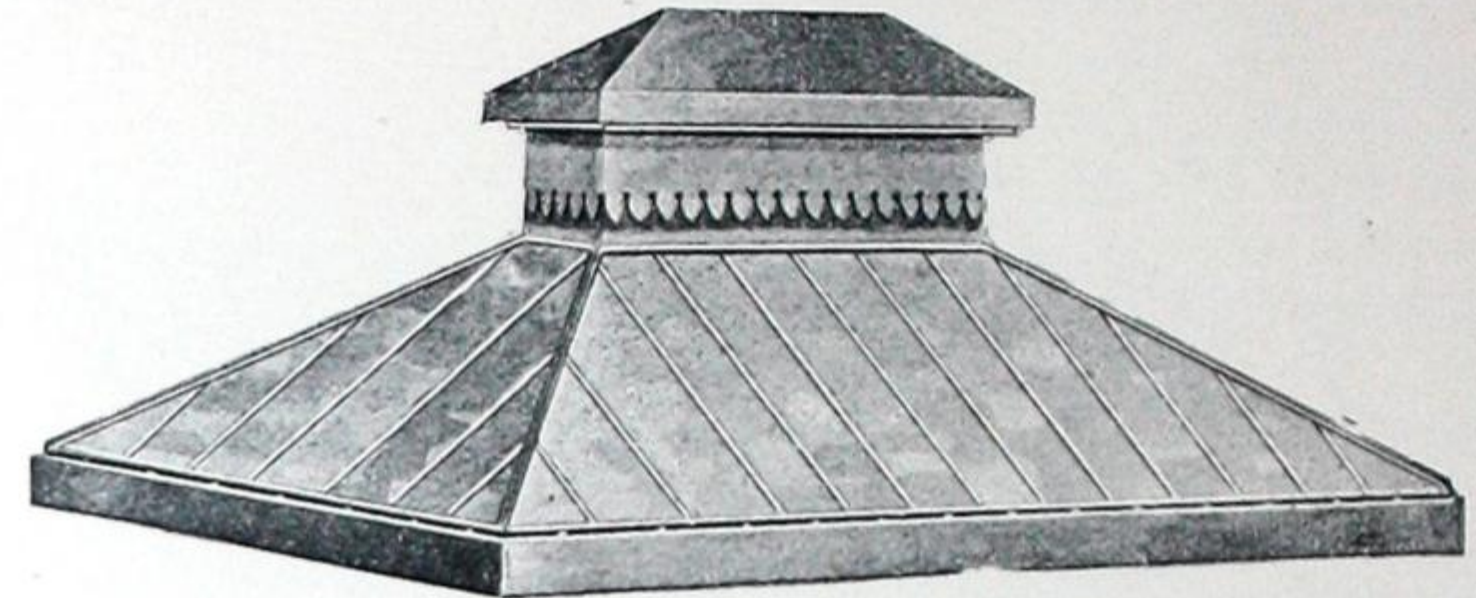

No. 1071.

Hipped Skylight with ridge ventilator. Dampers are not placed in ventilators on small sized skylights.

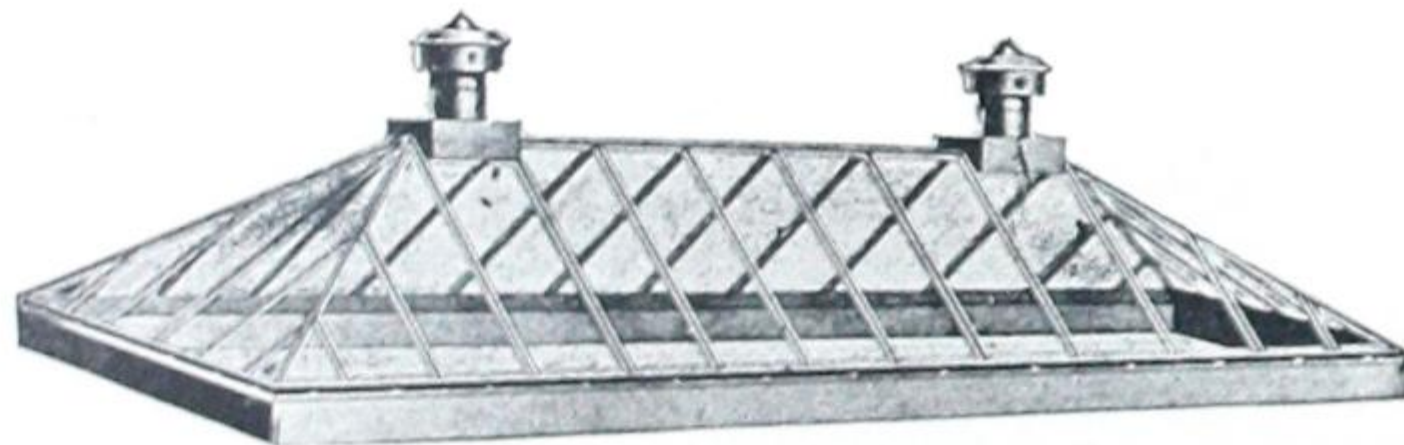

No. 1070.

Hipped Skylight, with ventilators on ridge. This form of ventilation is especially desirable on a hipped skylight, giving the desired effect without obstructing the light.

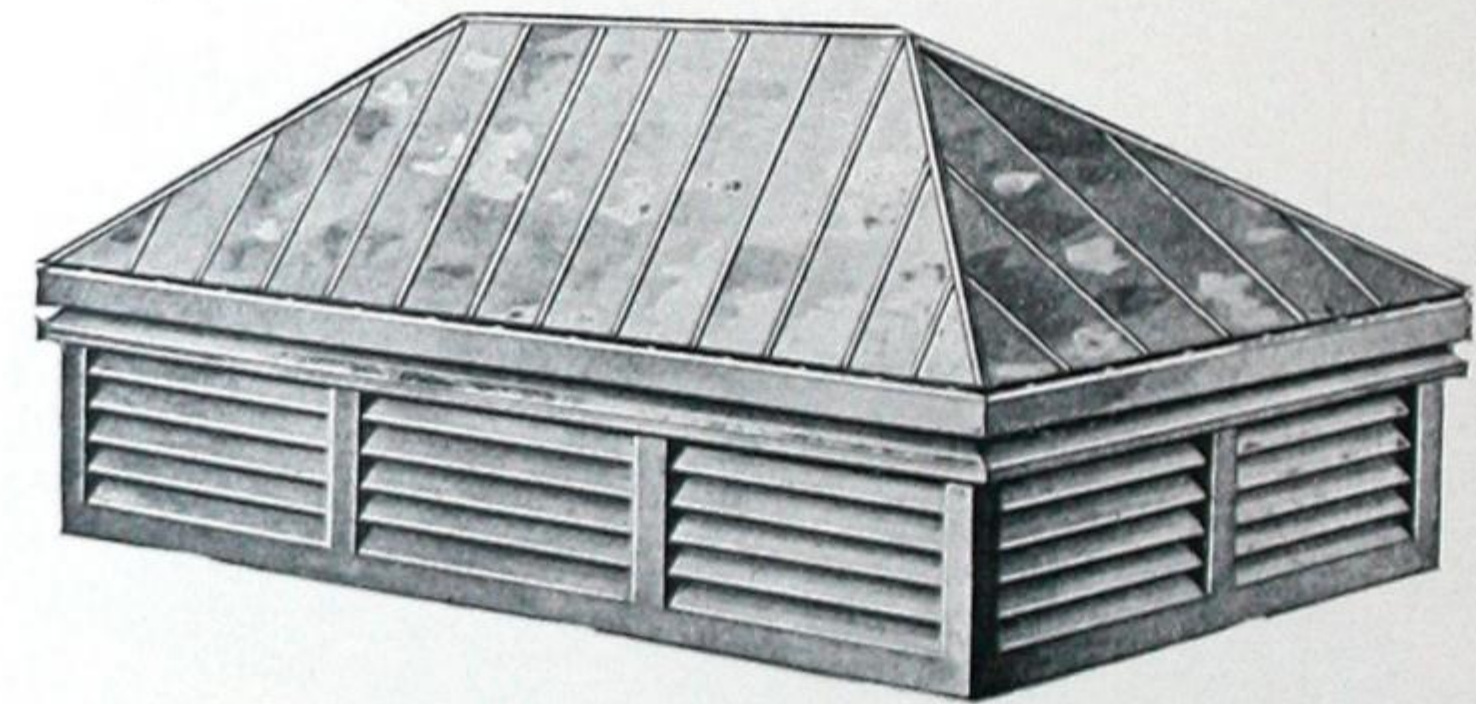

No. 1072.

Hipped Skylight. Well adapted for use on boiler rooms, factories, stables, etc. Made with stationary or movable slats, as desired. Mention kind of slats required.

Metallic Skylights.

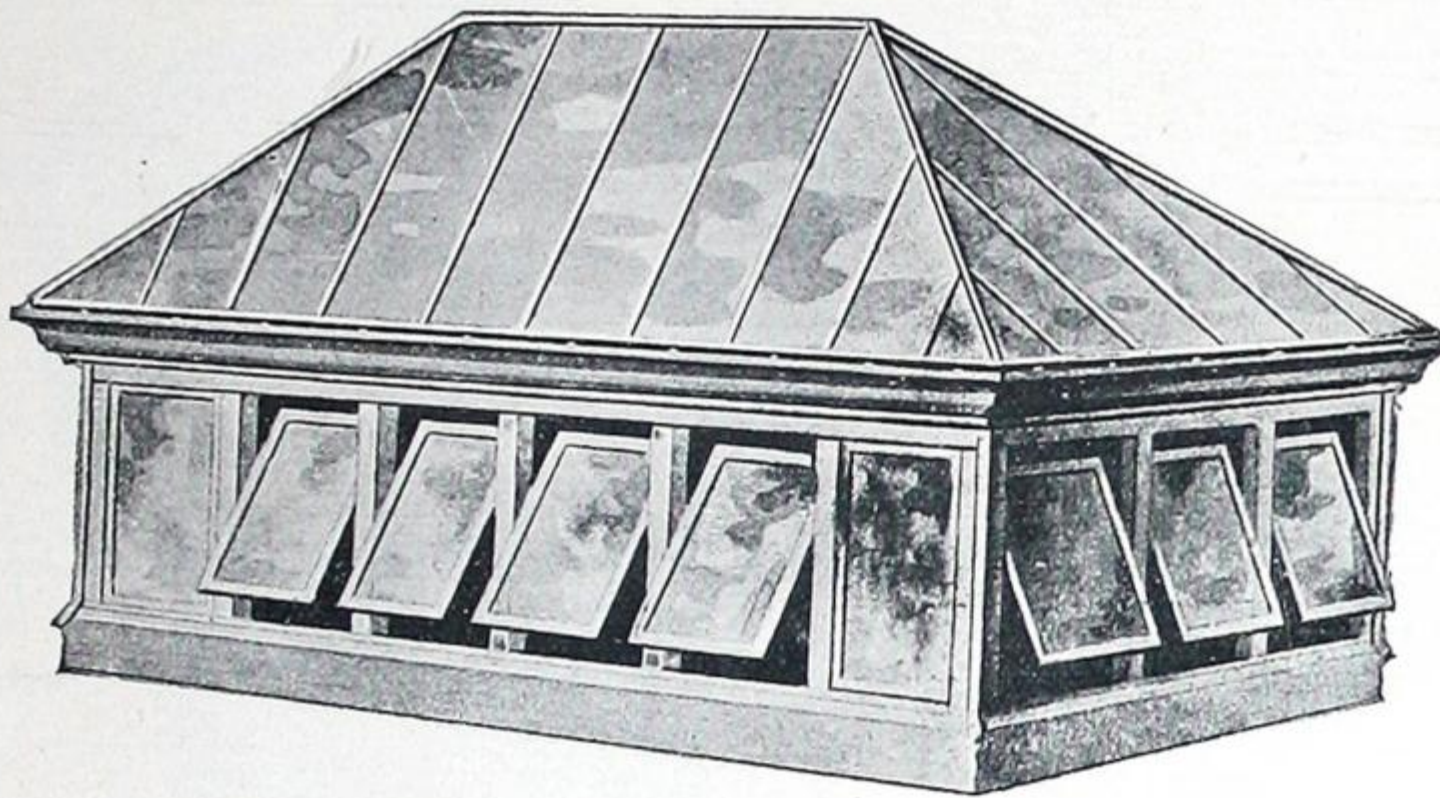

No. 1073.

Hipped Turret Skylight. The movable sash may be controlled by apparatus operated from floor below. See page 286.

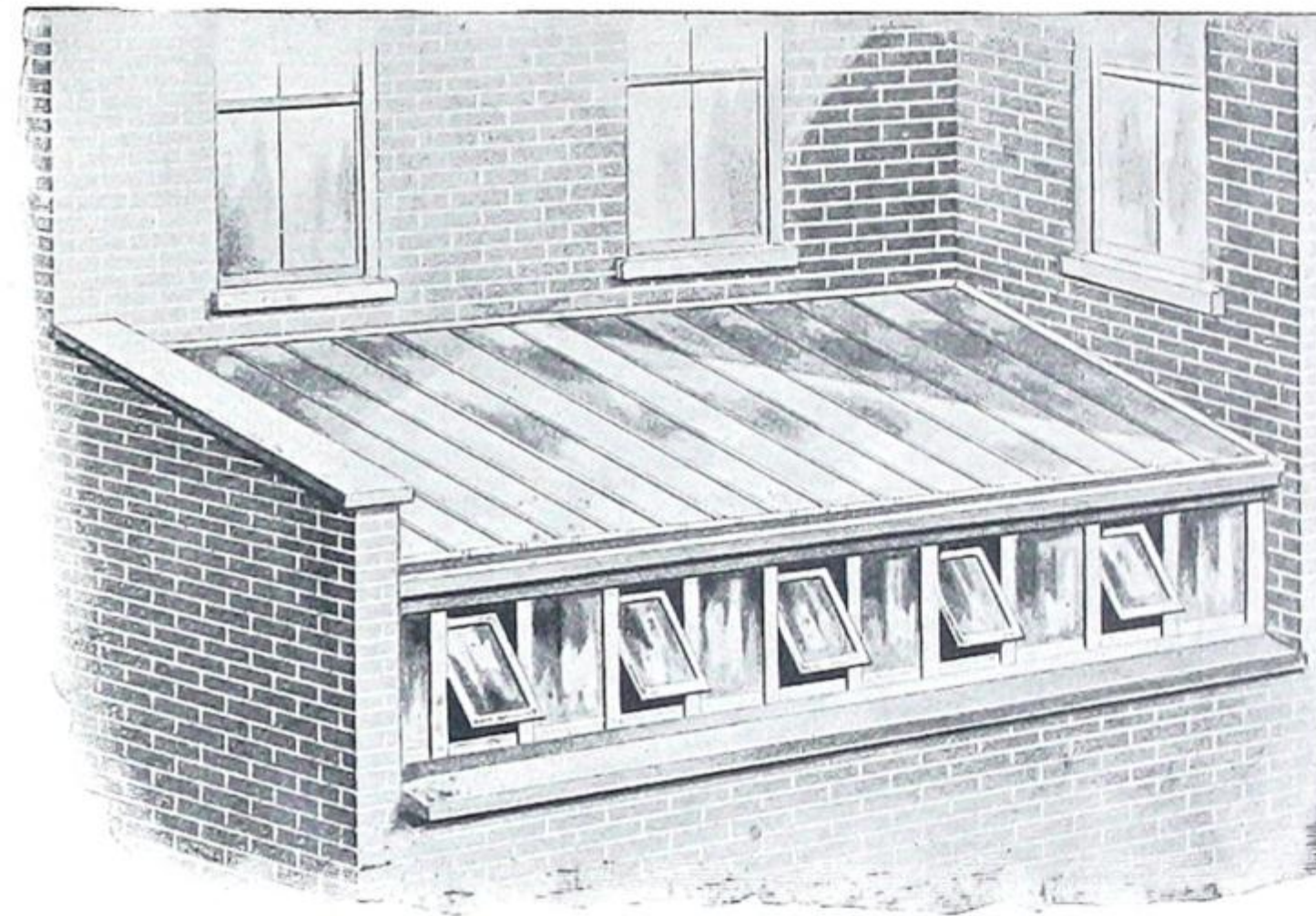

No. 1074.

Illustrates skylight in position on area-way or rear of building. The movable sash, as shown, make it possible to well ventilate a room, which is a very desirable feature. Opening apparatus shown on page 286.

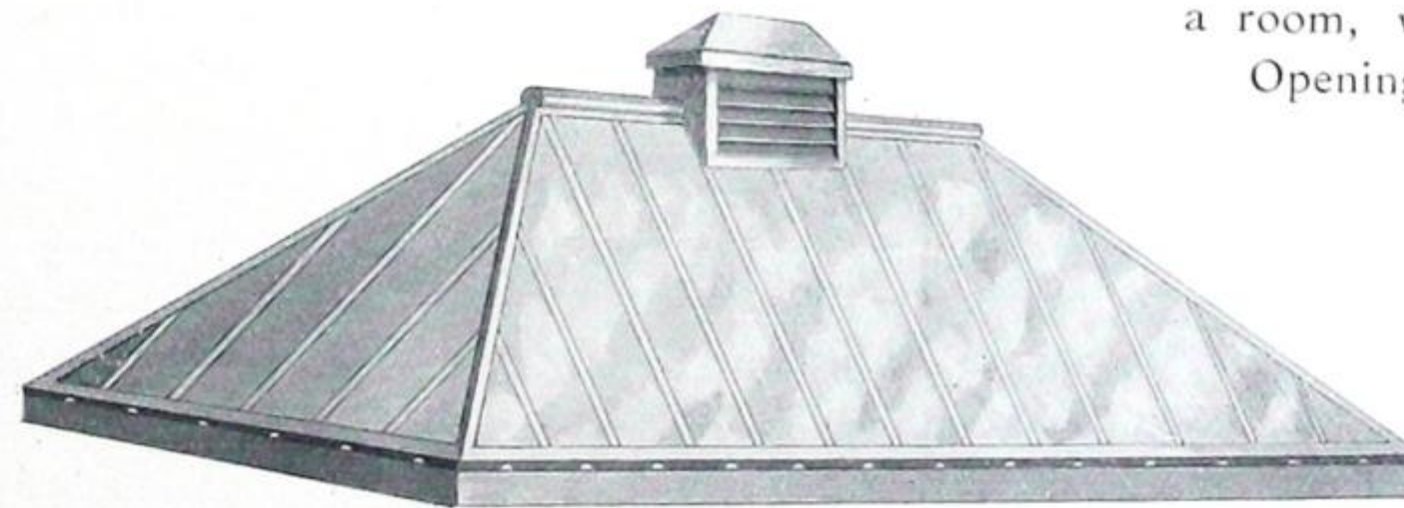

No. 1075.

Hipped Skylight, with oblong louvre ventilator.

Opening and Closing Apparatus for Sash in Skylights.

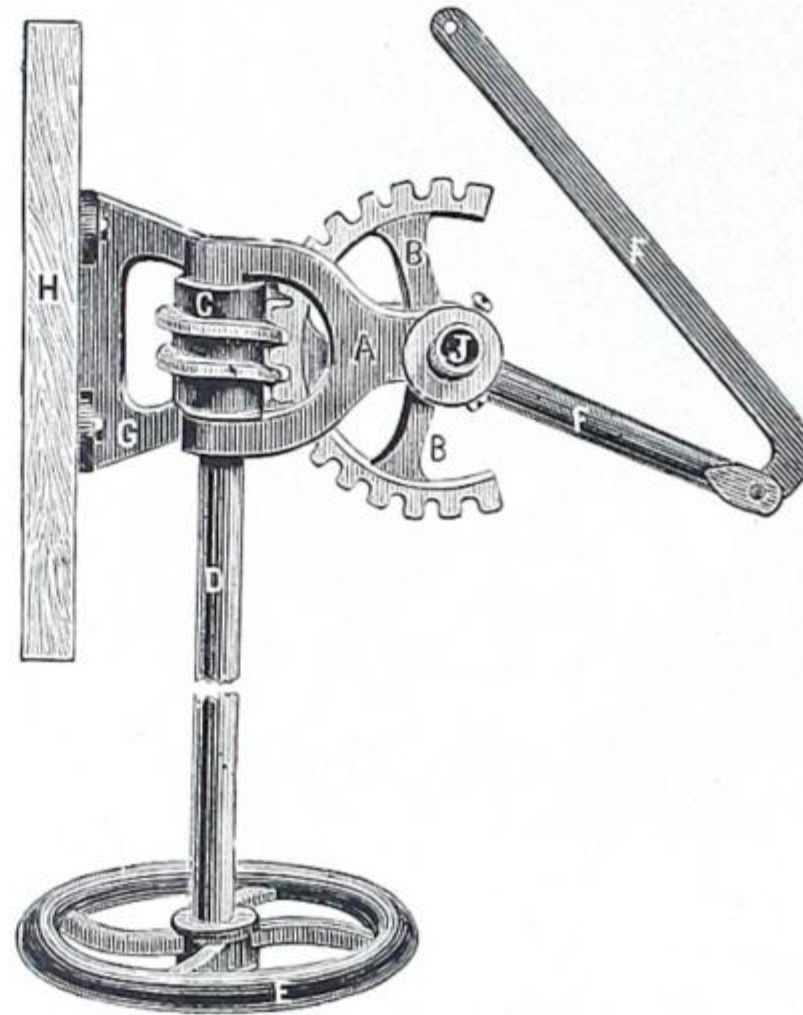

Fig. 225.

This illustrates our self-locking apparatus, and is a well arranged and effectual mode of opening and closing, at the same time locking in any position, any number of side lights simultaneously.

It consists of a worm **G** and sextant, cogged movement **B**, yoked **A** to a horizontal shaft **J**, and arranged with toggle arms **F** attached to the sashes. The method of operating is by means of a shaft the desired length, to which the worm is attached at one end, a hand wheel or cranked handle at the other. Where it is not convenient to have the handle always in position, a portable key the desired length may be substituted.

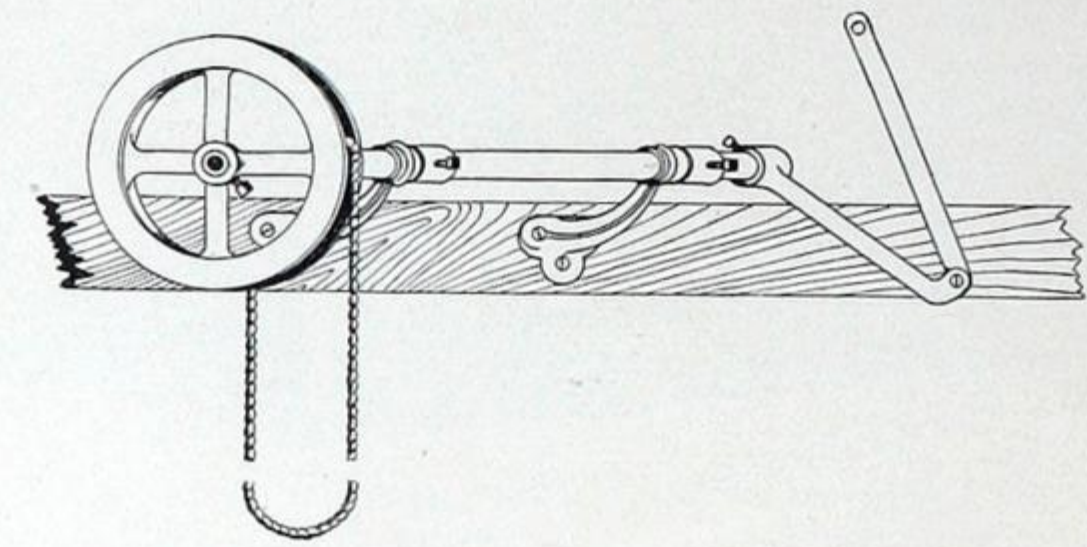

Fig. 226.

This illustrates another and cheaper mode for opening and closing sashes.

It consists of a horizontal shaft secured by brackets to the plate or fascia, toggle arms attached to the shaft and sash, and a wheel, over which a cord secured to the wheel in opposite directions passes. The wheel is operated by the cord, which turns the shaft and thereby works the toggle arms to open or close the sash.

The "HALITUS" Ventilator and Chimney Cowl.

REGISTERED TRADE MARK, "HALITUS."

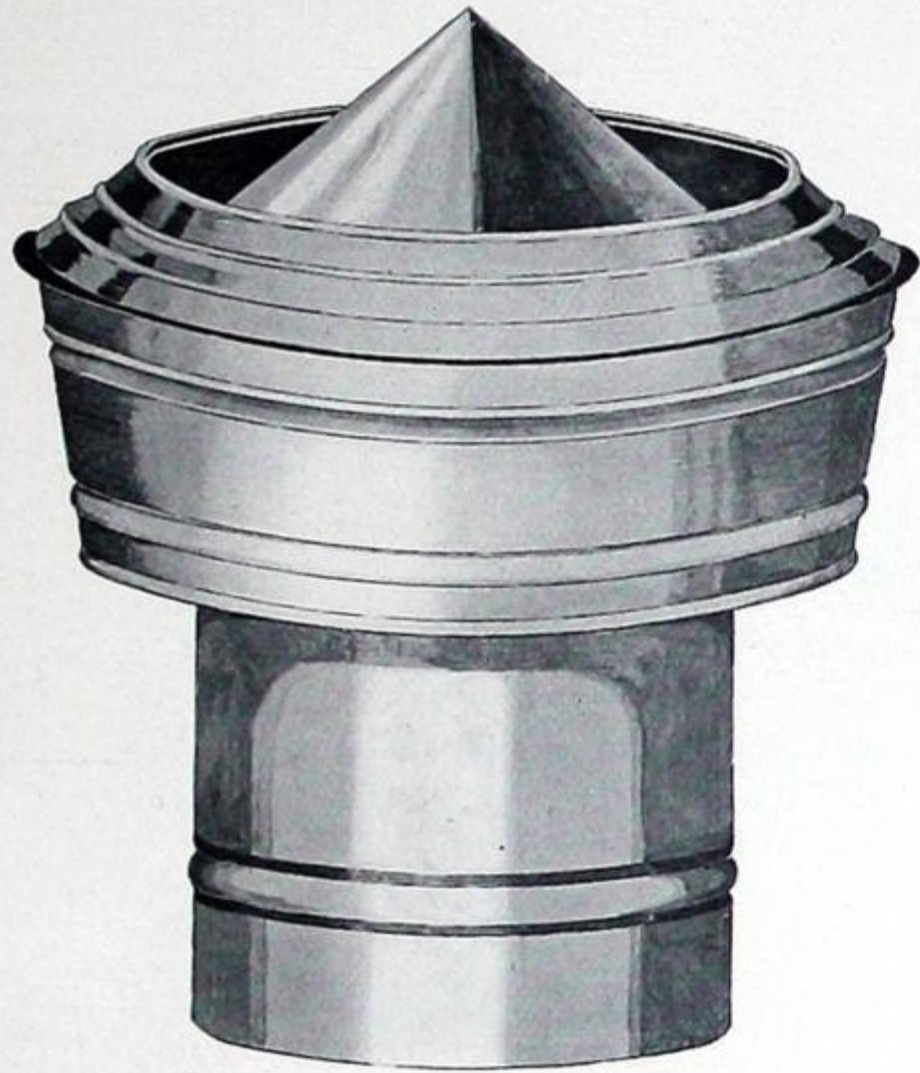

Fig. 227.—Complete View of Ventilator.

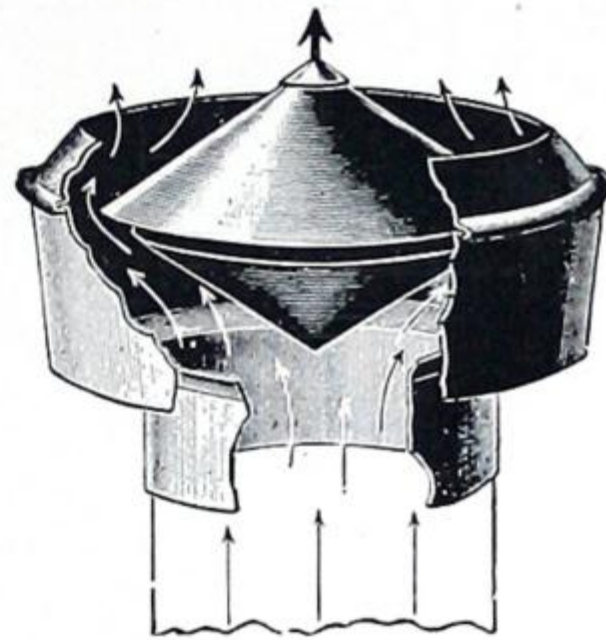

Fig. 228.—Broken View.

Made from galvanized steel, or from sheet copper.

The capacity in square inches of different sizes of Ventilators is as follows :

Diameter Neck Measure.	Capacity.	Diameter Neck Measure.	Capacity.
6 inch	28 square inches	32 inch	804 square inches
8 "	50 "	34 "	908 "
10 "	78 "	36 "	1017 "
12 "	113 "	40 "	1257 "
14 "	164 "	44 "	1620 "
15 "	177 "	48 "	1809 "
16 "	201 "	54 "	2390 "
18 "	255 "	60 "	2807 "
20 "	314 "	66 "	3456 "
22 "	380 "	72 "	4071 "
24 "	453 "	84 "	5539 "
26 "	521 "	90 "	6361 "
28 "	615 "	96 "	7238 "
30 "	707 "		

As will be seen from Fig. 228 these ventilators are constructed with an inside cone tapering upwards with a space between it and the outer cone. The action of the wind outside creates a vacuum in the flue, necessarily causing a positive upward draft under any conditions. This ventilator is constructed on scientific principles, and will exhaust more cubic feet of air per minute than any other storm-proof ventilator made. Nothing to get out of order, and no downward draft.

Ventilators may also be made with glass tops, glazed either with clear plate or rough rolled glass, so as to admit light. When so desired to regulate the draft, a damper may be put in the flue, which can be operated by a cord running to the floor. Glass tops or dampers are extra.

Bases.

Bases may be made any size or shape desired. Bases are not included, and are not sent unless specially ordered, in which case shape and sizes must be given.

The "Halitus" Ventilator Tested.

The following table prepared by Prof. C. H. C. Wright, of the School of Practical Science, Toronto, after an actual test made by him of the "Halitus" Ventilator.

"Volume of air in cubic feet per hour discharged through a short flue, due to the action of a horizontal wind on the "Halitus" Ventilator, when the air inside and outside of the flue are at the same temperature. (This discharge is independent of that due to temperature.)"

Velocity of Wind in Miles Per Hour.	6-Inch Diameter.	8-Inch Diameter.	10-Inch Diameter.	12-Inch Diameter.	16-Inch Diameter.	20-Inch Diameter.	24-Inch Diameter.	36-Inch Diameter.
1	144	256	400	576	1024	1600	2304	5184
2	288	512	800	1152	2048	3200	4608	10368
3	432	768	1200	1728	3072	4800	6911	15551
4	576	1024	1600	2304	4096	6400	9215	20734
5	720	1280	2000	2880	5120	8000	11519	25918
6	864	1536	2400	3435	6144	9599	13823	31102
7	1008	1792	2800	4032	7167	11199	16127	36285
8	1152	2048	3200	4608	8191	12799	18431	41496
9	1296	2304	3600	5184	9215	14399	20734	46652
10	1440	2560	4000	5760	10239	15999	23038	51836
11	1586	2816	4400	6336	11263	17598	25342	57020
12	1728	3072	4800	6911	12286	19198	27646	62203
13	1872	3328	5200	7487	13310	20798	29950	67387
14	2010	3584	5600	8063	14334	22398	32254	72571
15	2160	3840	6000	8639	15358	23998	34557	77754
16	2304	4096	6400	9215	16382	25598	36861	82938
17	2448	4352	6799	9791	17406	27198	39165	88121
18	2592	4608	7199	10367	18430	28798	41469	93305
19	2736	4864	7599	10943	19454	30398	43772	98488
20	2880	5120	7999	11519	20477	31998	46076	103672
25	3600	6400	9999	14398	25597	39997	57596	129590
30	4320	7679	11999	17278	30717	47996	69115	155508
35	5040	8959	13998	20158	35836	55996	80634	181426
40	5760	10239	15998	23037	40956	63995	92154	207344

It will be noticed that these figures are based on the conditions of the inside air being the same temperature as that outside. If the air inside were warmer than outside, the volume discharged through the ventilator would be very much more, and increasing proportionately with the greater the difference in the temperature. An excess of 10° in the temperature inside over outside, on a 6-inch ventilator, with flue only one foot high, would add 400 cubic feet per hour to the figures given in the foregoing table.

Assuming, however, the temperature inside and outside to be the same, it will be seen by the table, that if a room 40 x 40 feet, with ceiling 13 feet high, were provided with two of our 24-inch "Halitus" Ventilators, the air would be changed twice an hour, with the wind outside blowing only nine miles an hour.

METALLIC CORNICES.

Copper or Galvanized Steel.



We are not at all limited to the designs shown in our catalogue, but can furnish, equally as well, any cornice or other architectural work, made to any detail required, in either copper or galvanized steel.

We have the very latest and most approved machinery for the rapid and accurate production of all descriptions of this class of work, and shall be pleased to submit estimates on receipt of drawings and specifications.

Cornices are furnished complete in as large sections as convenient for transportation, with all brackets, mouldings and ornaments attached, thereby avoiding any difficulty in erection, and making it an easy matter for any mechanic to put up the work.

Our galvanized cornices are made from the very finest of cold rolled, bright, smooth galvanized steel sheets, and are all first crimped before forming. All work is guaranteed to be first-class in every respect.

Any of the designs shown are subject to modification, and can be either enlarged, reduced, or changed to suit the requirements.

Unless otherwise mentioned, we do not supply the roof or covering for the top of the cornice, as this is made of flat galvanized iron or steel. We can, however, supply the roof covering when so ordered.

Directions for Ordering Cornices.

In ordering, kindly be explicit, and state fully your wants. Do not assume that we know them. Send plan of your building, with accurate figured measurements of wall at the foot of cornice. Mention whether cornice is for a new building and is to be built in, or for a building already finished. Should any of the mitres be other than square, give the exact angle. Always order by numbers. State if cornice is to be returned or if end blocks are required. All orders should be placed in plenty of time before material is required, about two weeks if possible, as all cornices have to be specially made up after order is received.

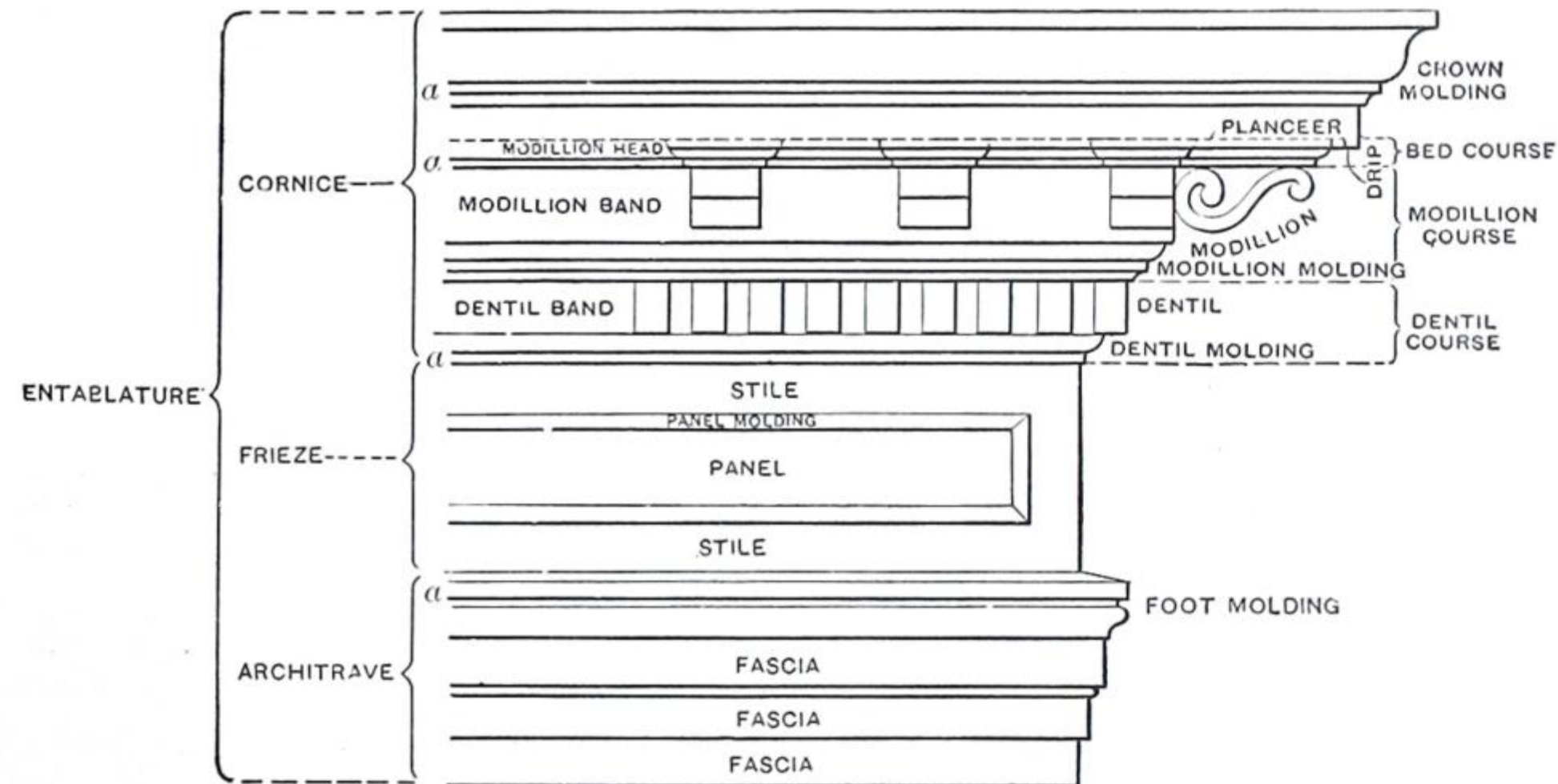
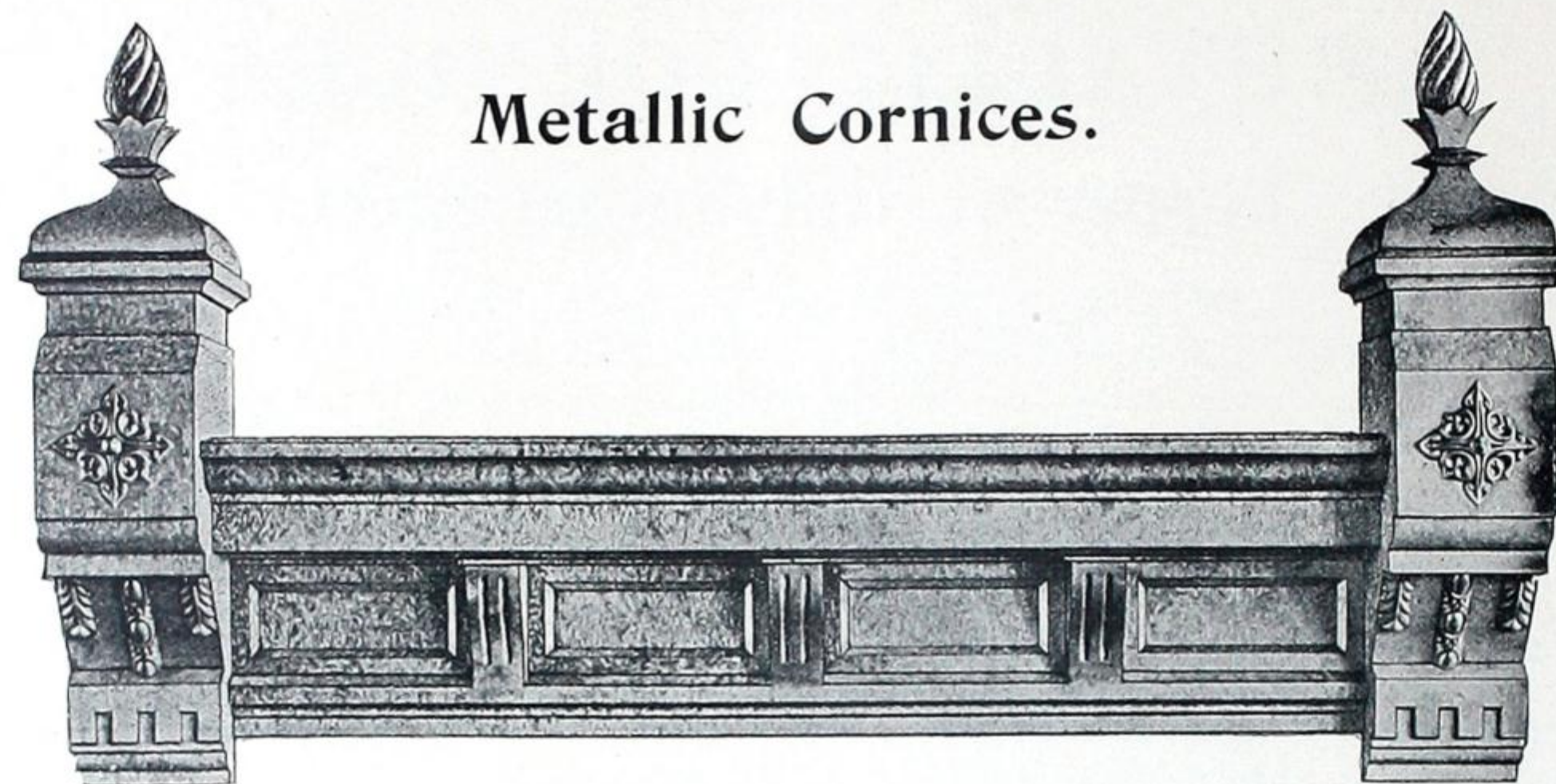

Fig. 229—The Several Parts of a Cornice.

The illustration shows the names given to the different parts of a cornice, as generally understood by architects and cornice makers.

Metallic Cornices.



No. 1150—Height, 24 inches ; projection, 12 inches.
No. 1151— “ 30 “ “ 15 “

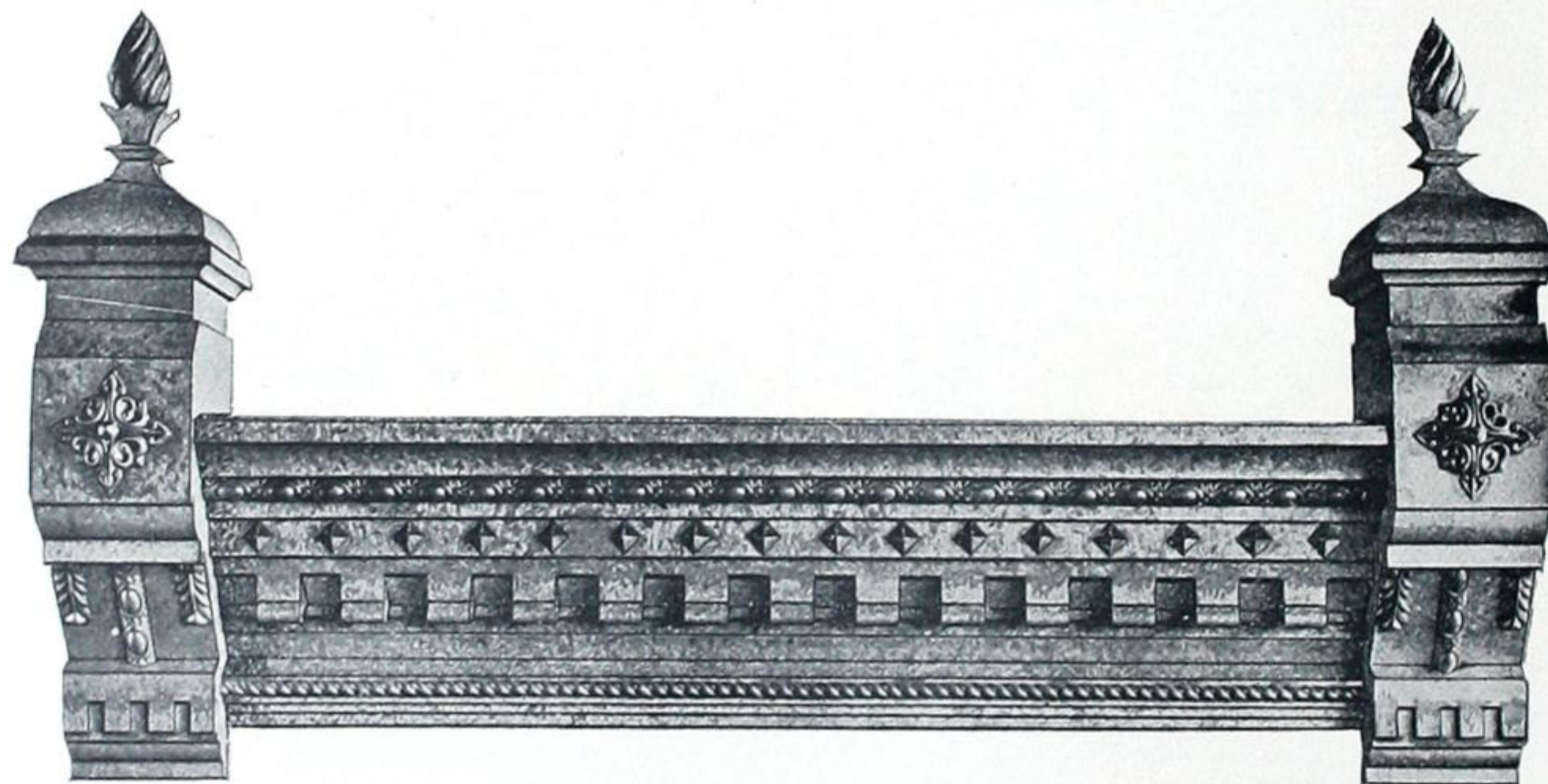

No. 1152—Height, 24 inches ; projection, 14 inches.
No. 1153— “ 30 “ “ 18 “

Metallic Cornices.

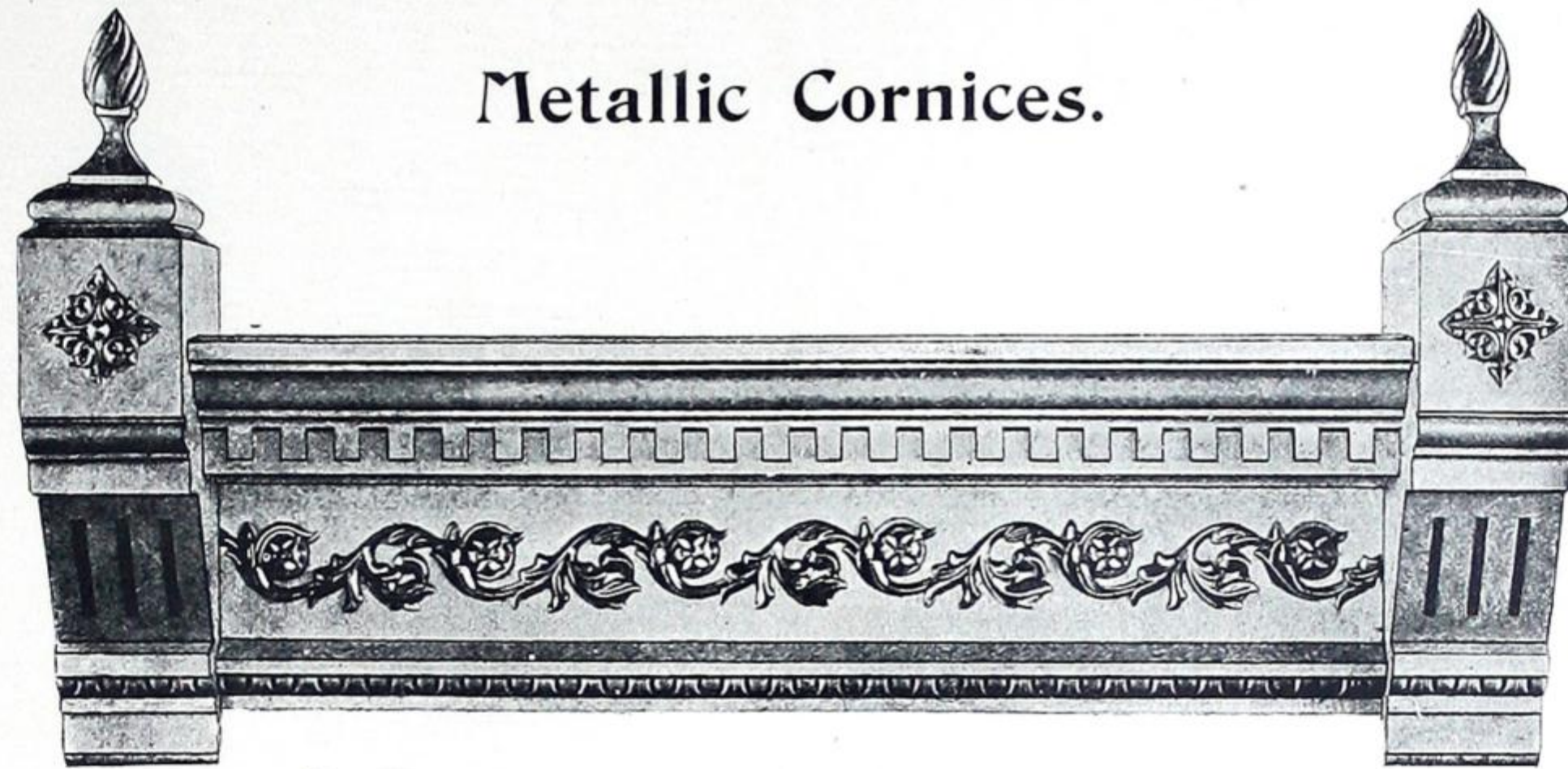

No. 1154—Height, 24 inches ; projection, 12 inches.
No. 1155— “ 30 “ “ 15 “

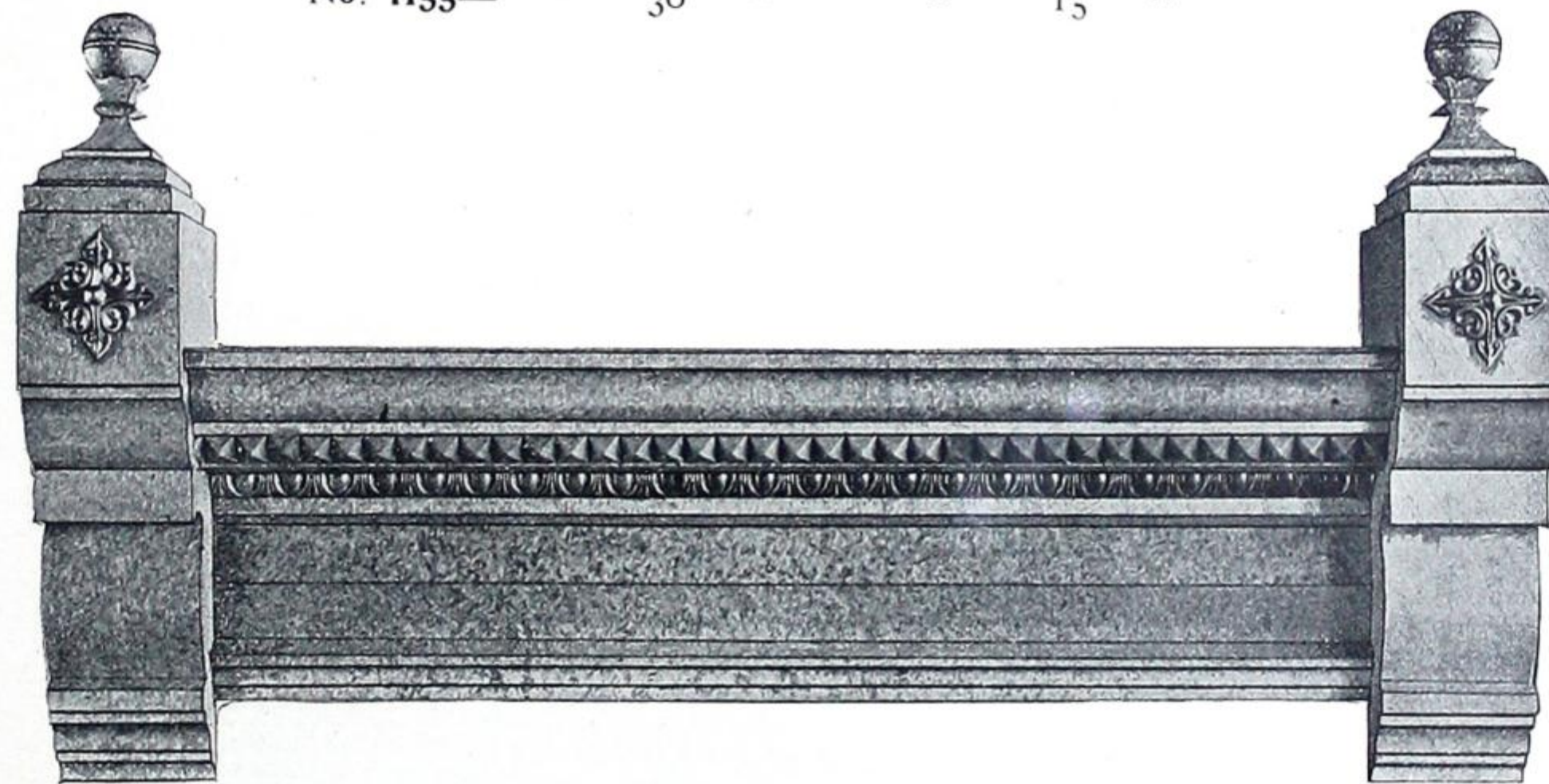

No. 1156—Height, 28 inches ; projection, 12 inches.
No. 1157— “ 30 “ “ 12 “
No. 1158— “ 36 “ “ 15 “

Metallic Cornices.

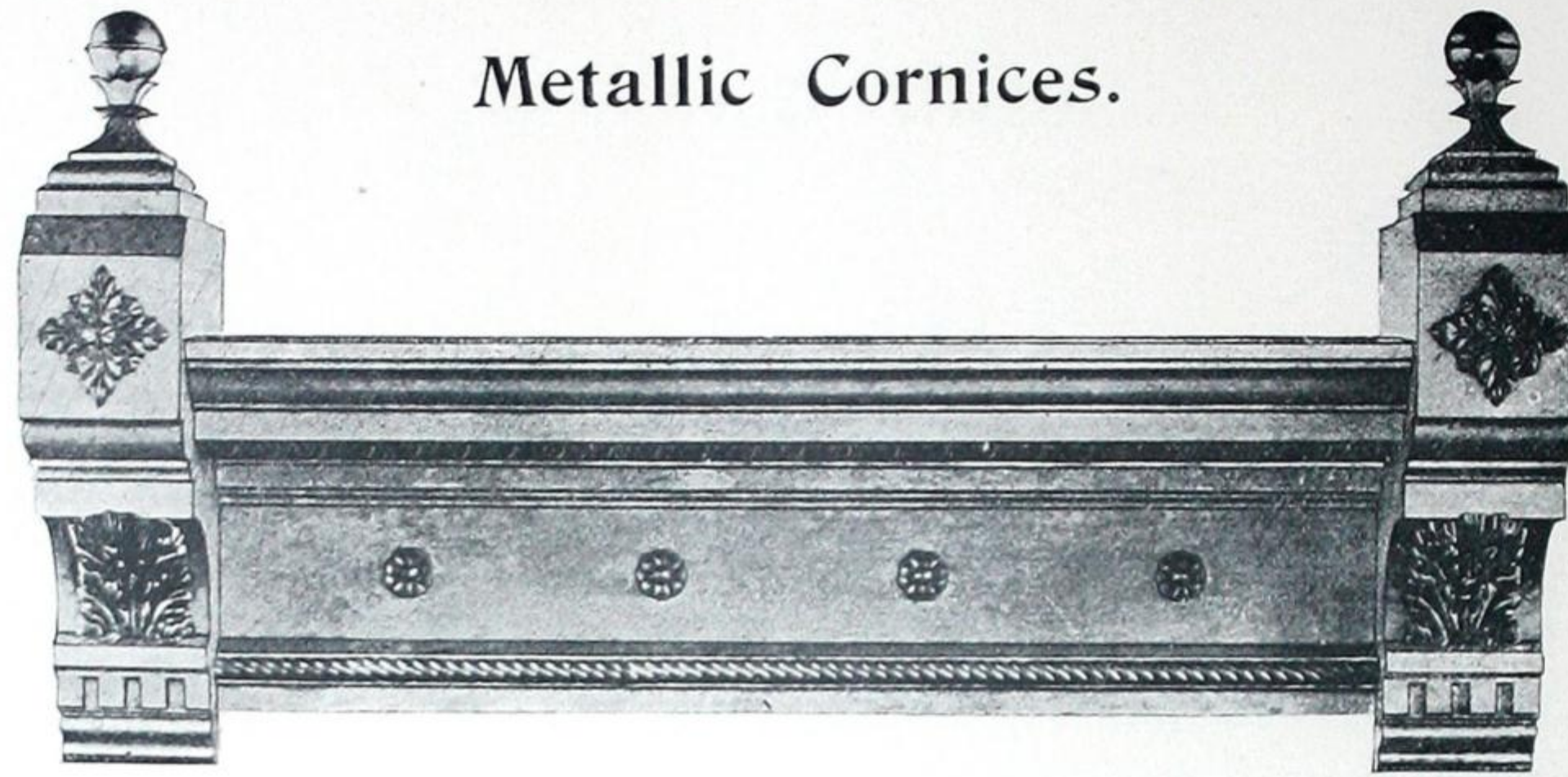

No. 1159—Height, 24 inches ; projection, 14 inches.
No. 1160— “ 30 “ “ 17 “

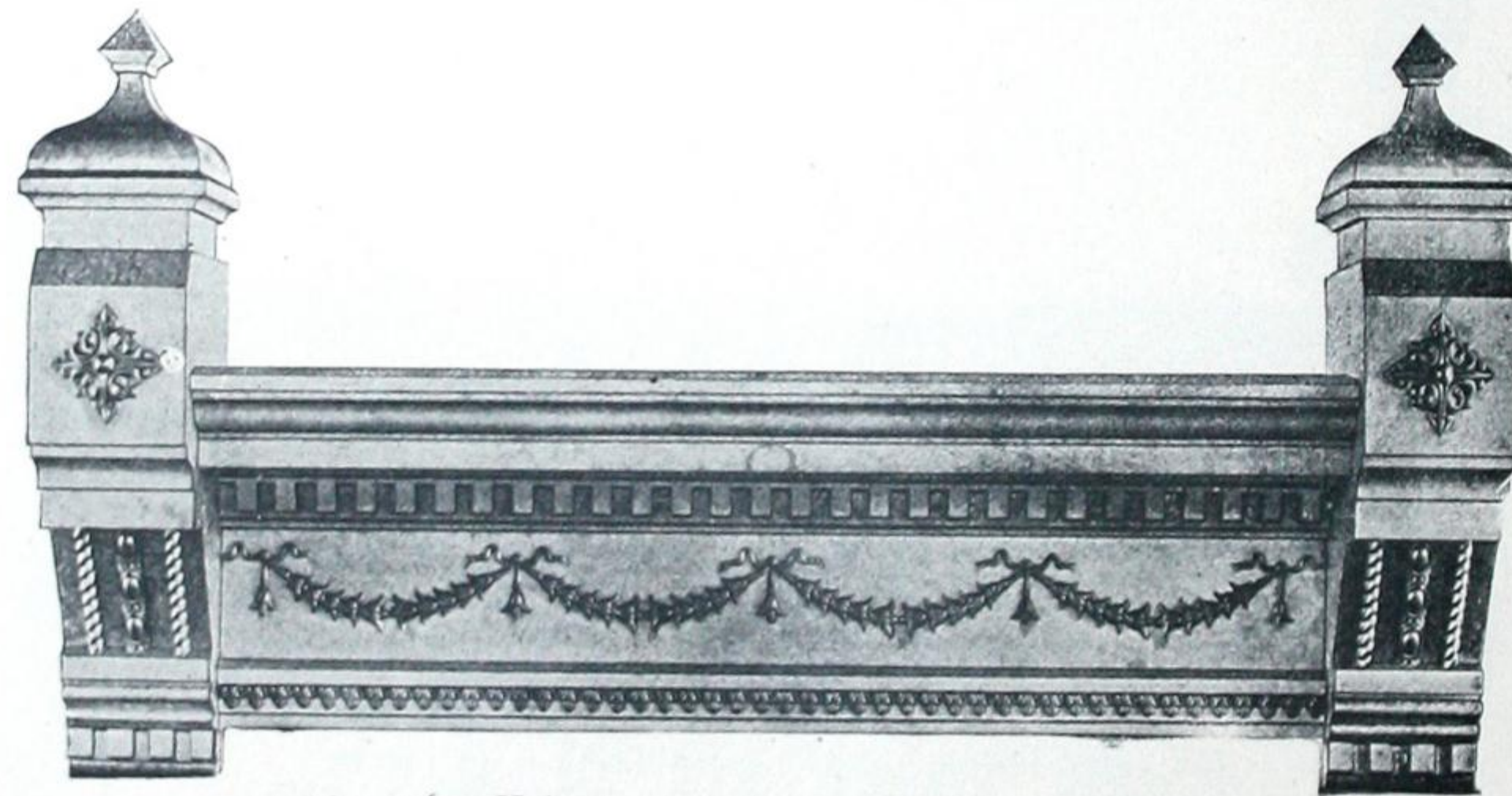

No. 1161—Height, 30 inches ; projection, 17 inches.
No. 1162— “ 36 “ “ 20 “

Metallic Cornices.

No. 1163—Height, 28 inches ; projection, 12 inches.
 No. 1164— “ 30 “ “ 12 “
 No. 1165— “ 36 “ “ 15 “

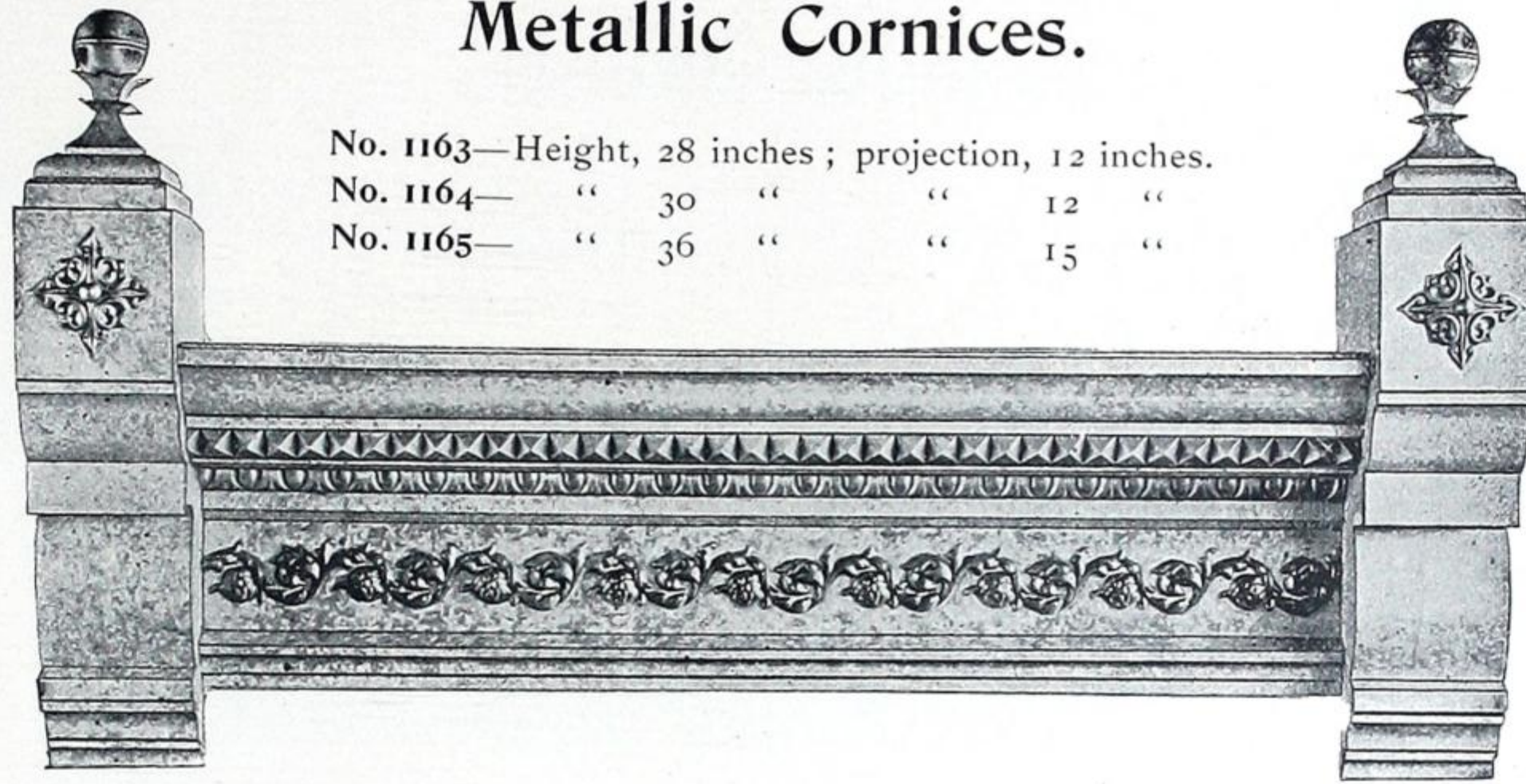

No. 1166—Height, 24 inches ; projection, 12 inches.
 No. 1167— “ 28 “ “ 16 “
 No. 1168— “ 30 “ “ 18 “
 No. 1169— “ 36 “ “ 20 “

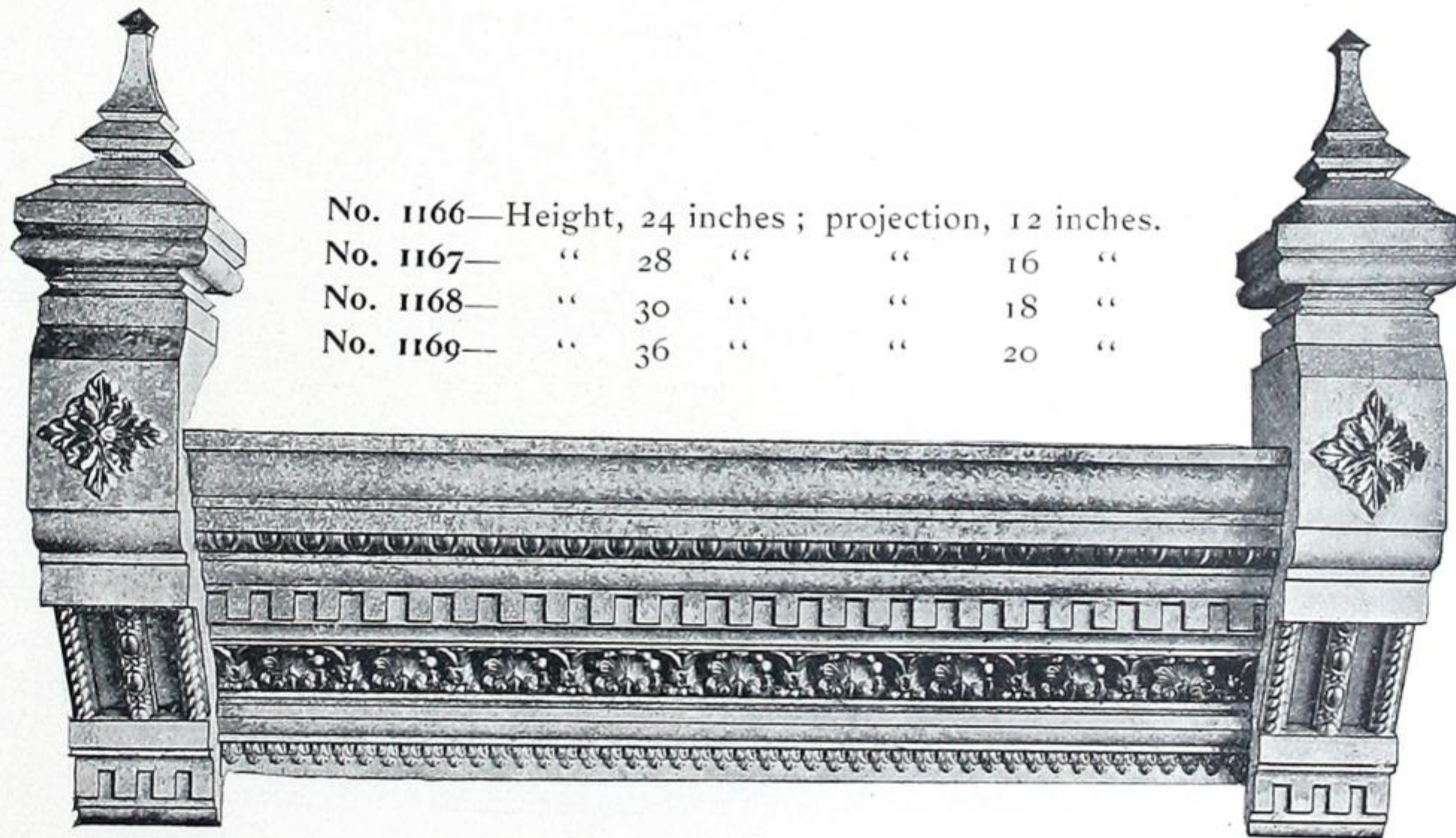

Metallic Cornices.

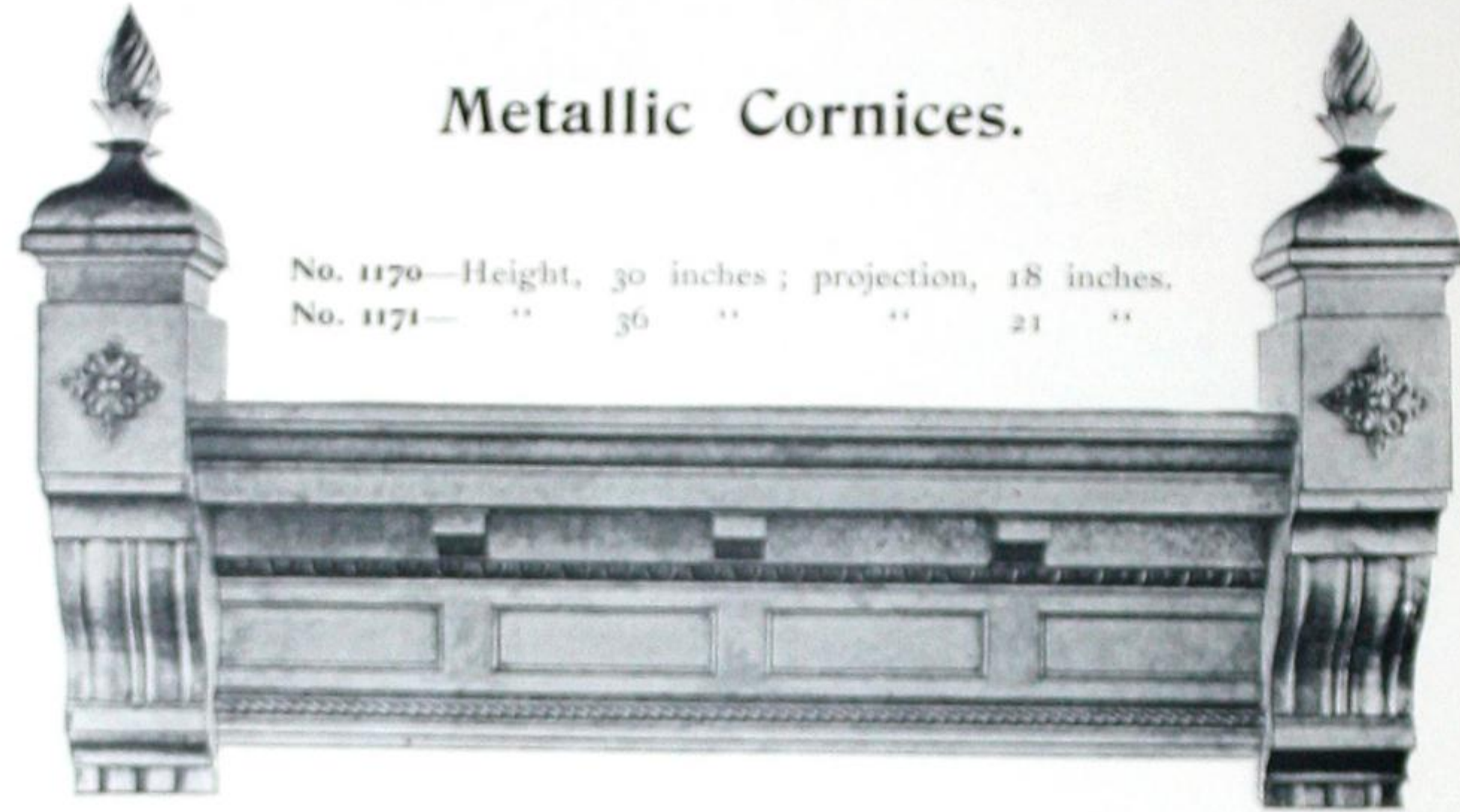

No. 1170—Height, 30 inches ; projection, 18 inches.
No. 1171— " 36 " " 21 "

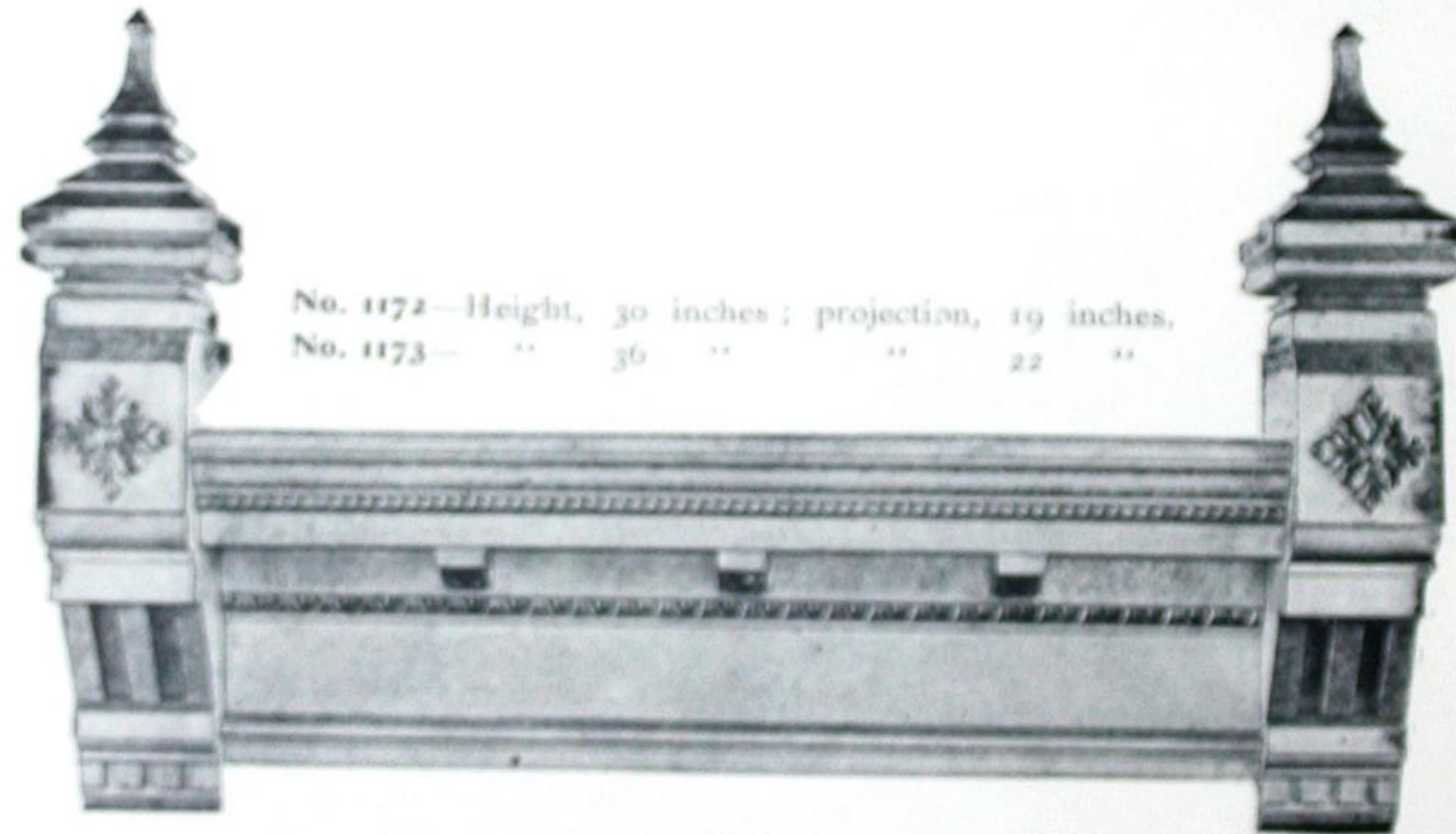

No. 1172—Height, 30 inches ; projection, 19 inches.
No. 1173— " 36 " " 22 "

Metallic Cornices.

No. 1174—Height, 30 inches; projection, 19 inches.

No. 1175— “ 36 “ “ 22 “

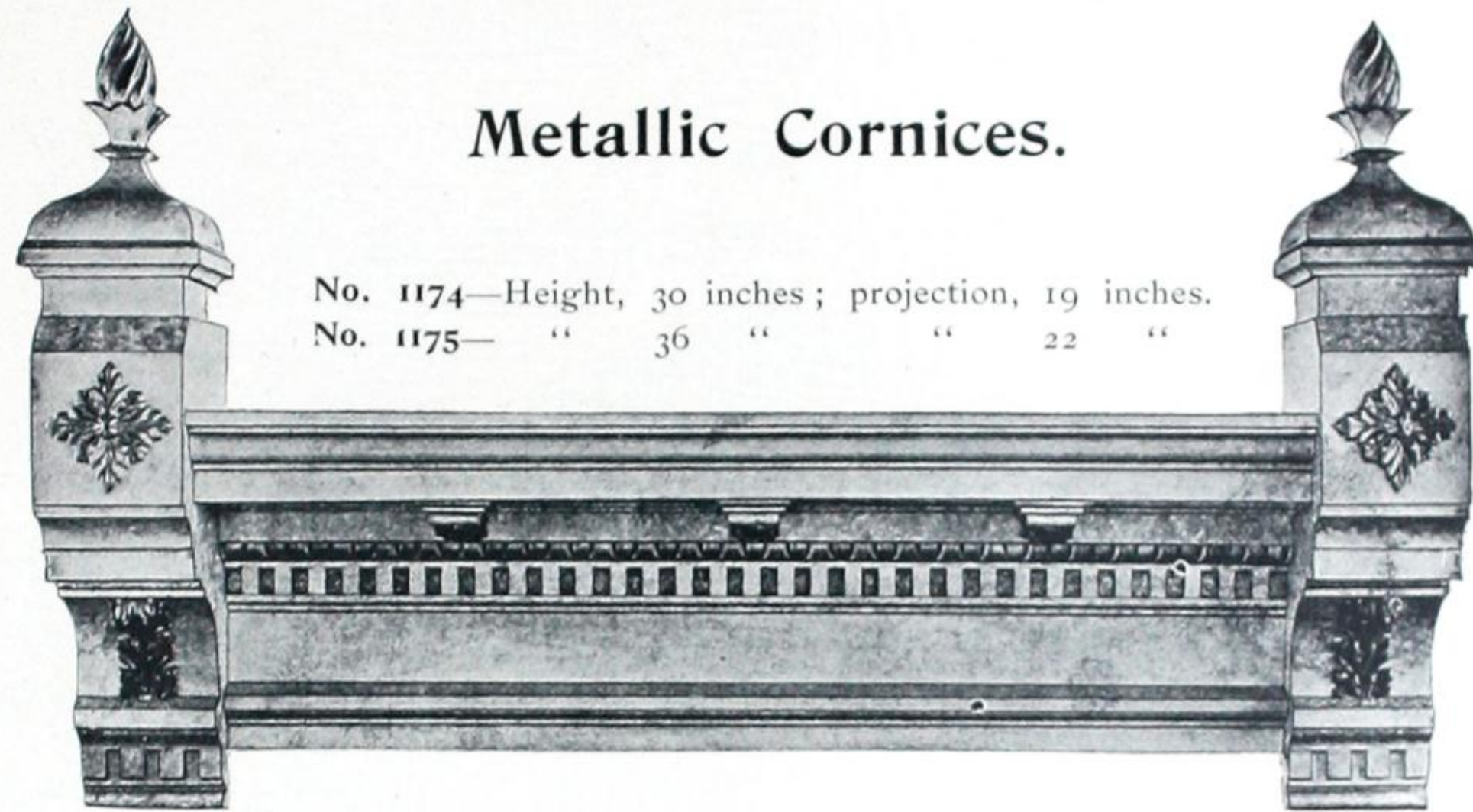

No. 1176—Height, 30 inches; projection, 20 inches.

No. 1177— “ 36 “ “ 24 “

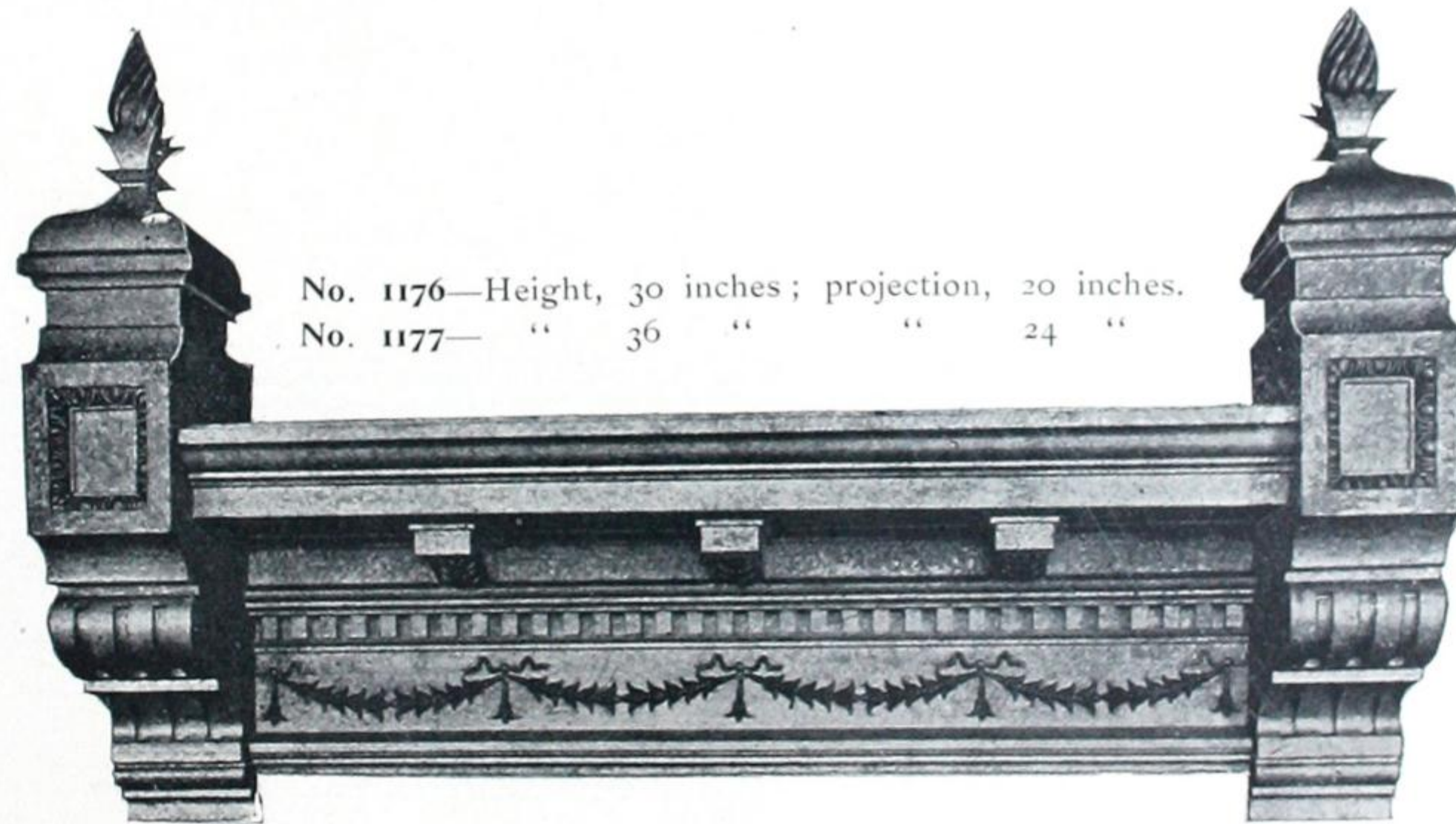

Metallic Cornices.

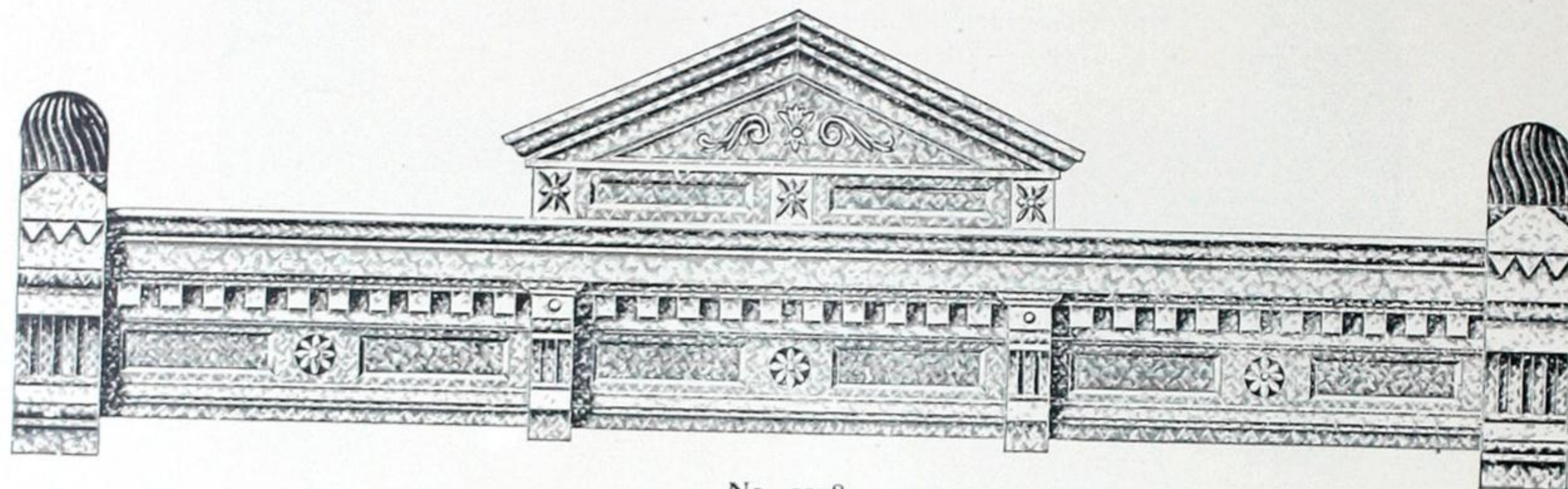

No. 1178.

Height, 30 inches ; projection, 18 inches ; pediment, 6 feet long.

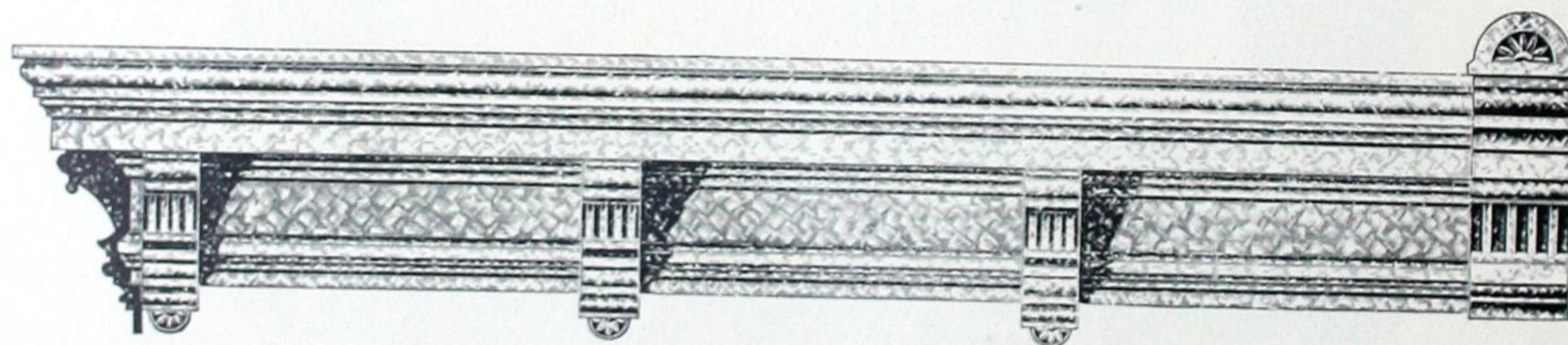

No. 1179.

Height, 25 inches ; projection, 14 inches. Brackets are spaced 4 feet centres.

Metallic Cornices.

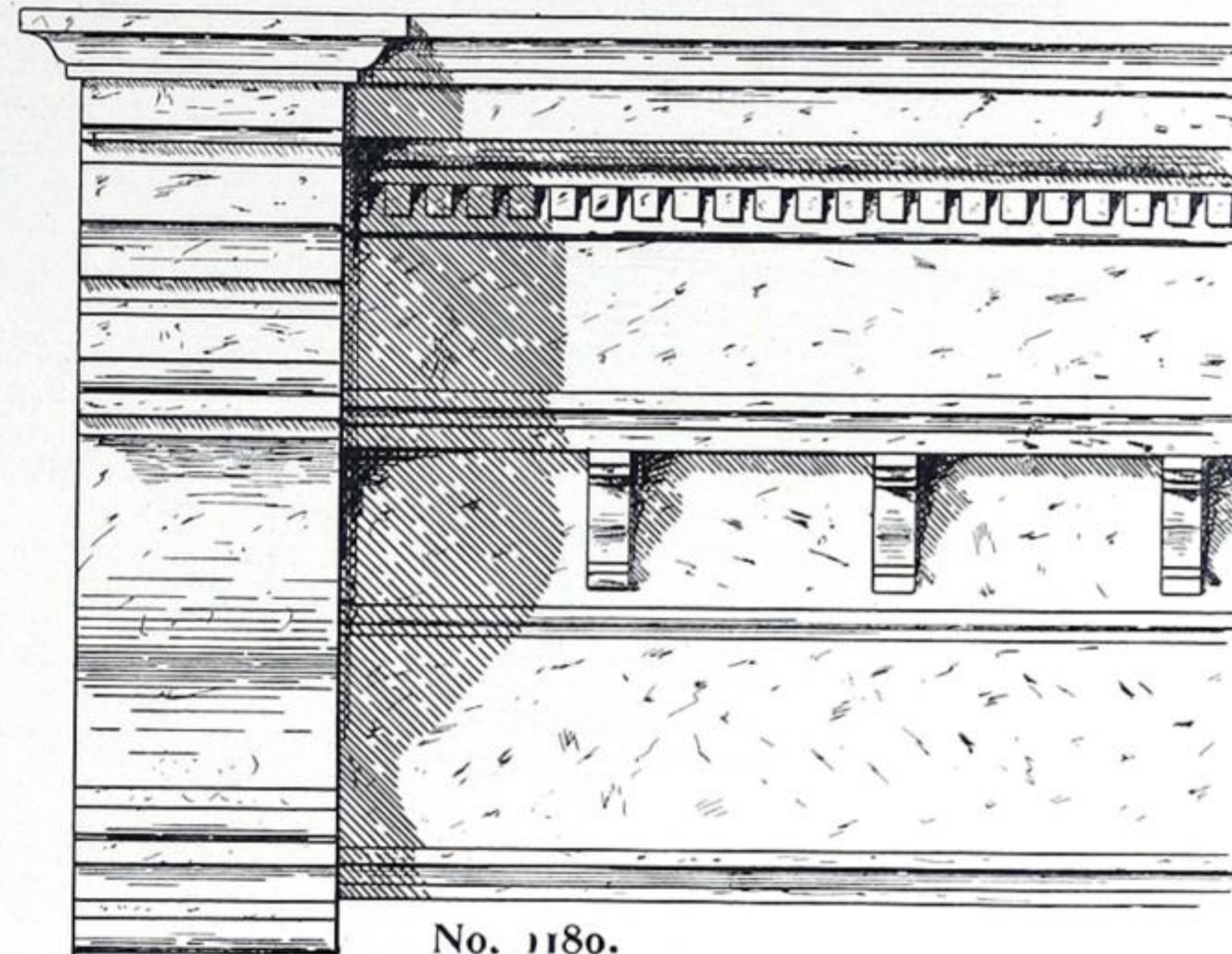
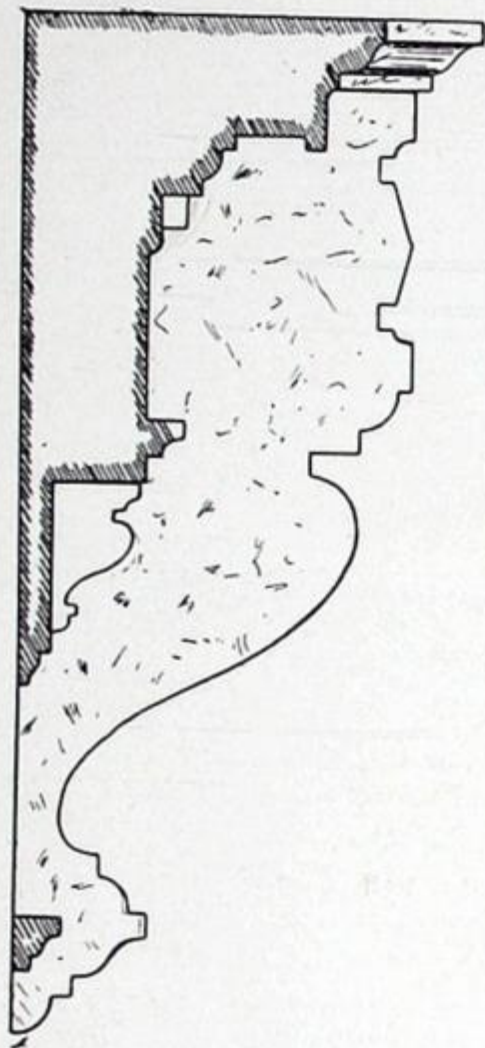

No. 1180.

Height, 60 inches.
Projection, 24 inches.
Can also be made in other sizes.

Height, 48 inches.
Projection, 21 inches.
Can also be made in other sizes.

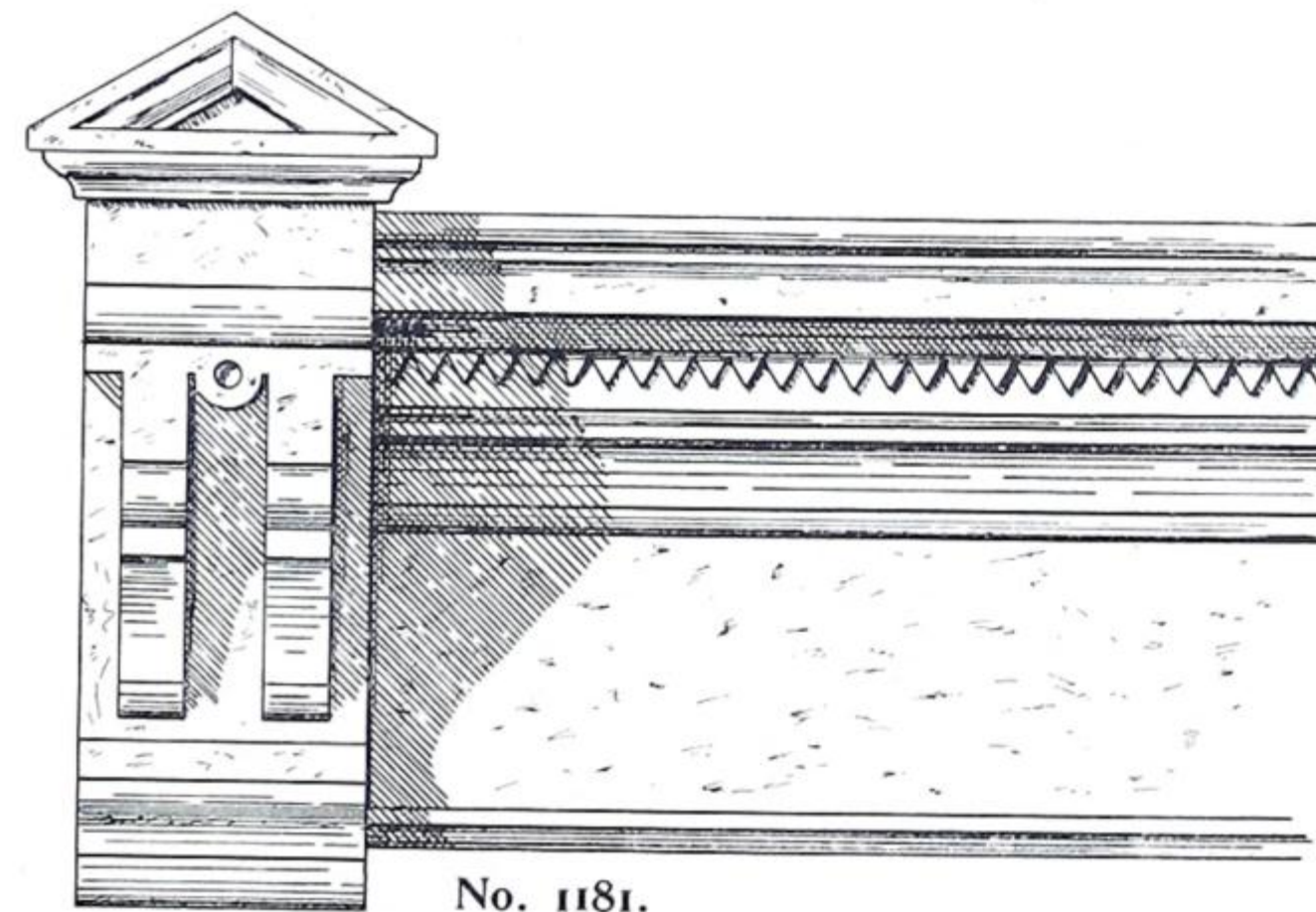
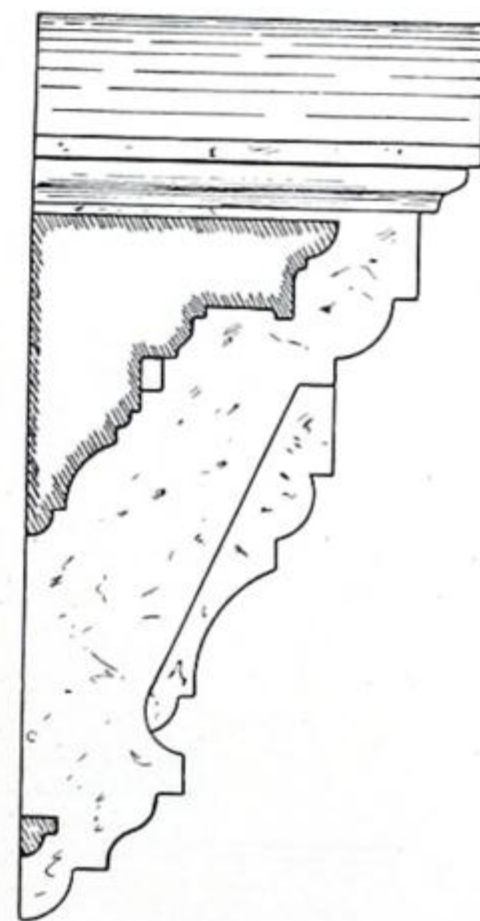

No. 1181.

Metallic Cornices.

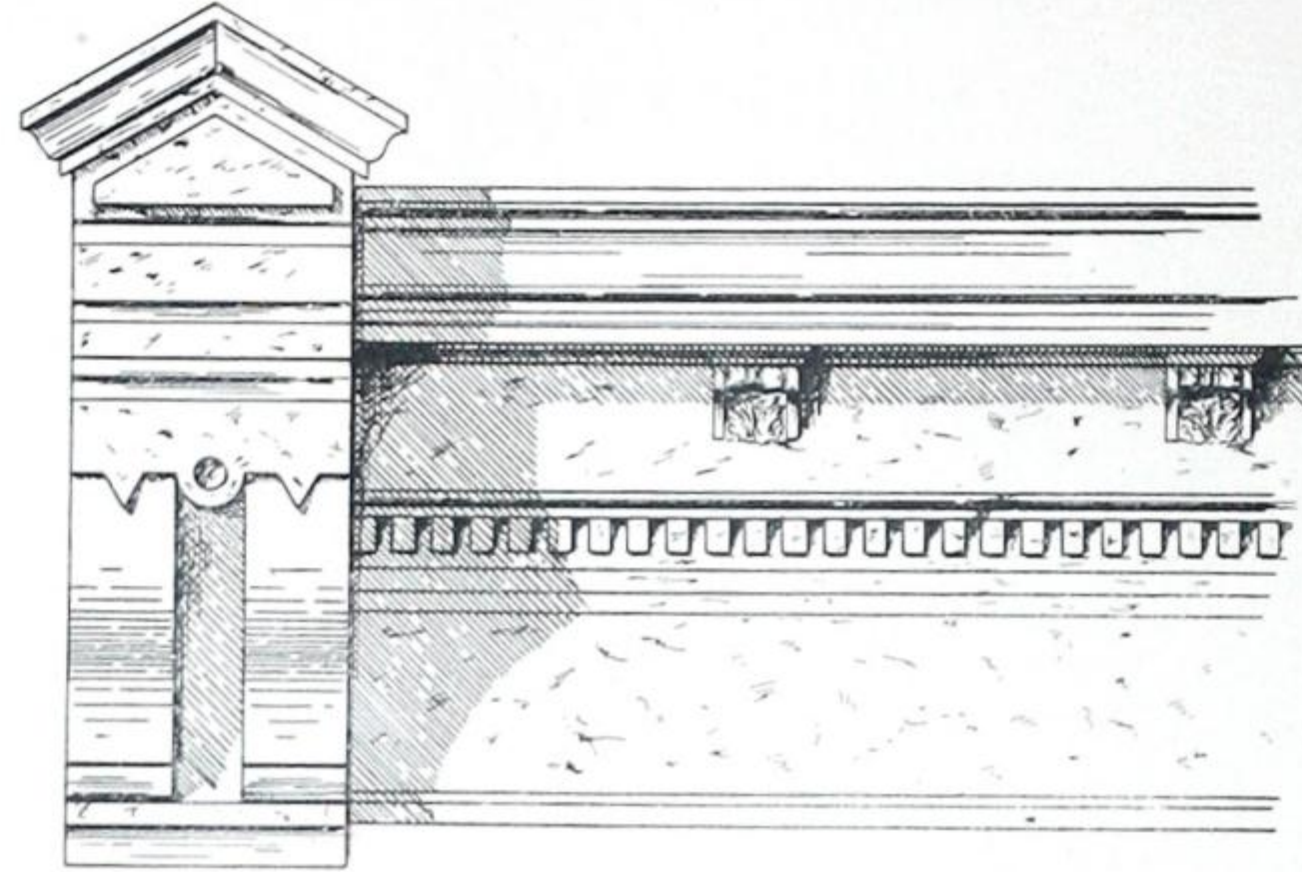
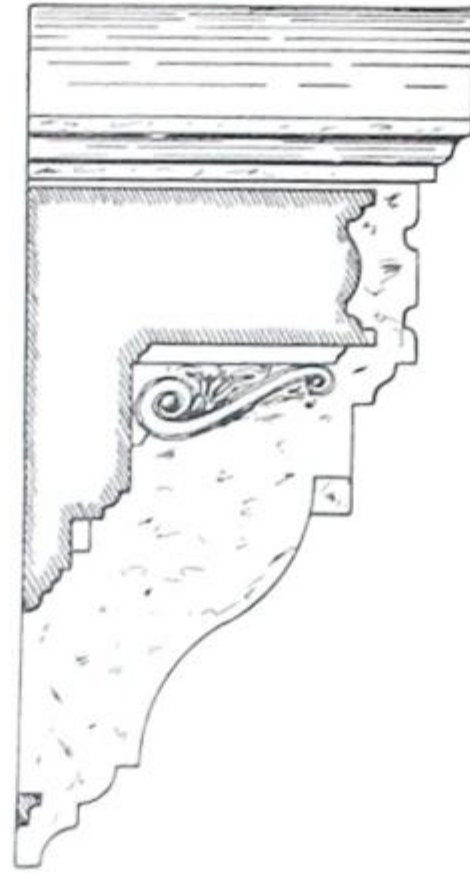

No. 1182.

Height, 48 inches.
Projection, 20 inches.
Can also be made in other sizes.

Height, 42 inches.
Projection, 20 inches.
Can also be made in other sizes.

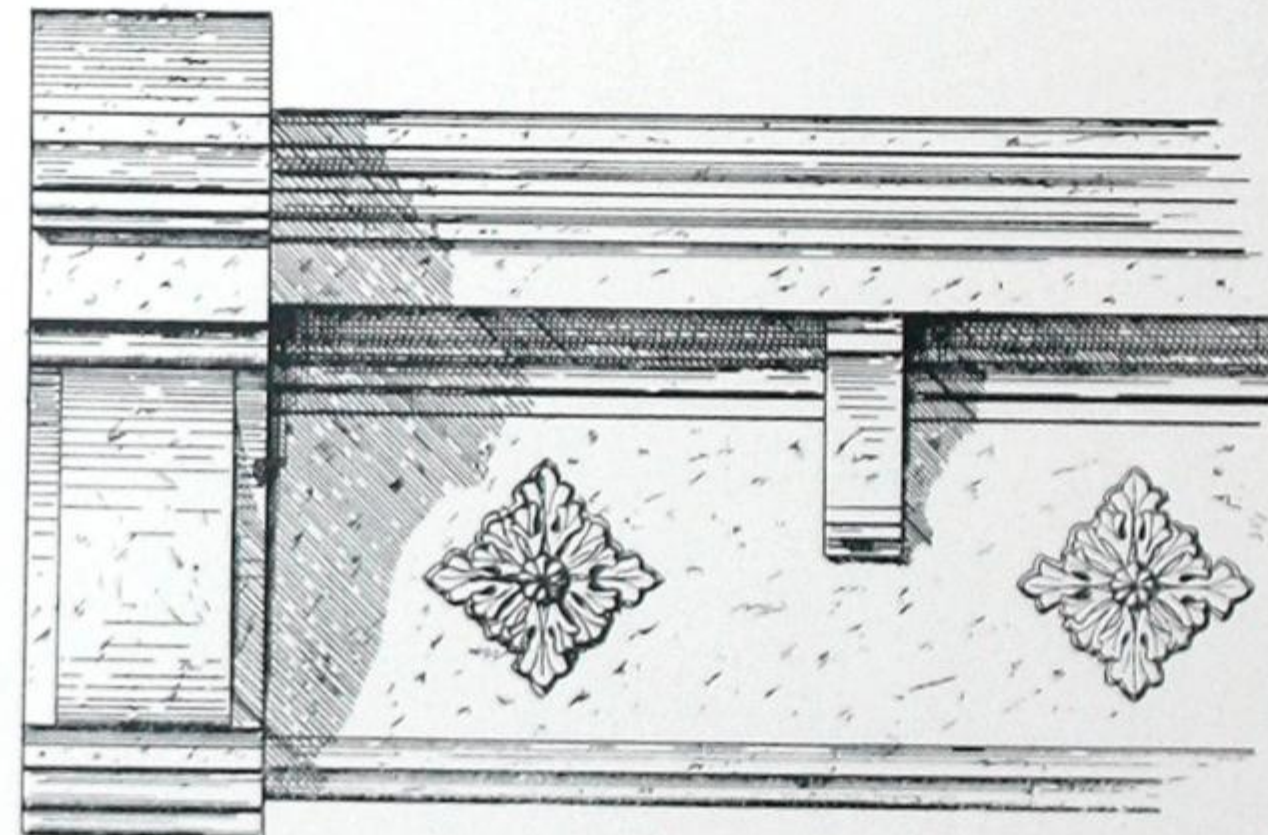
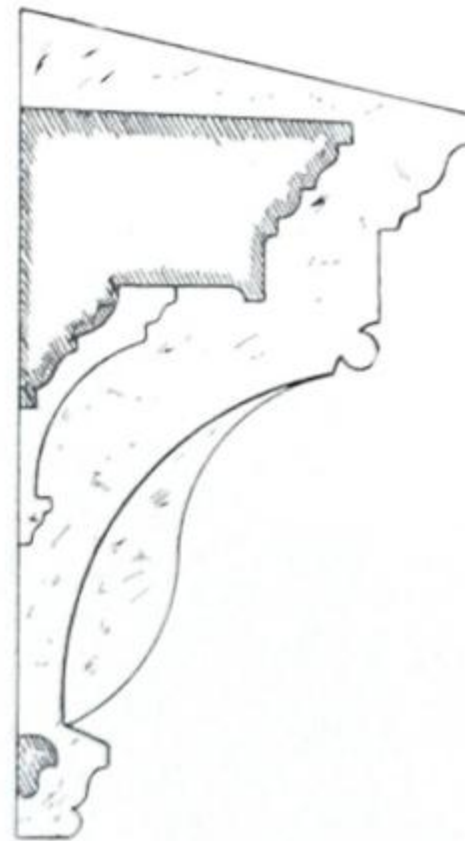

No. 1183.

Metallic Cornices.

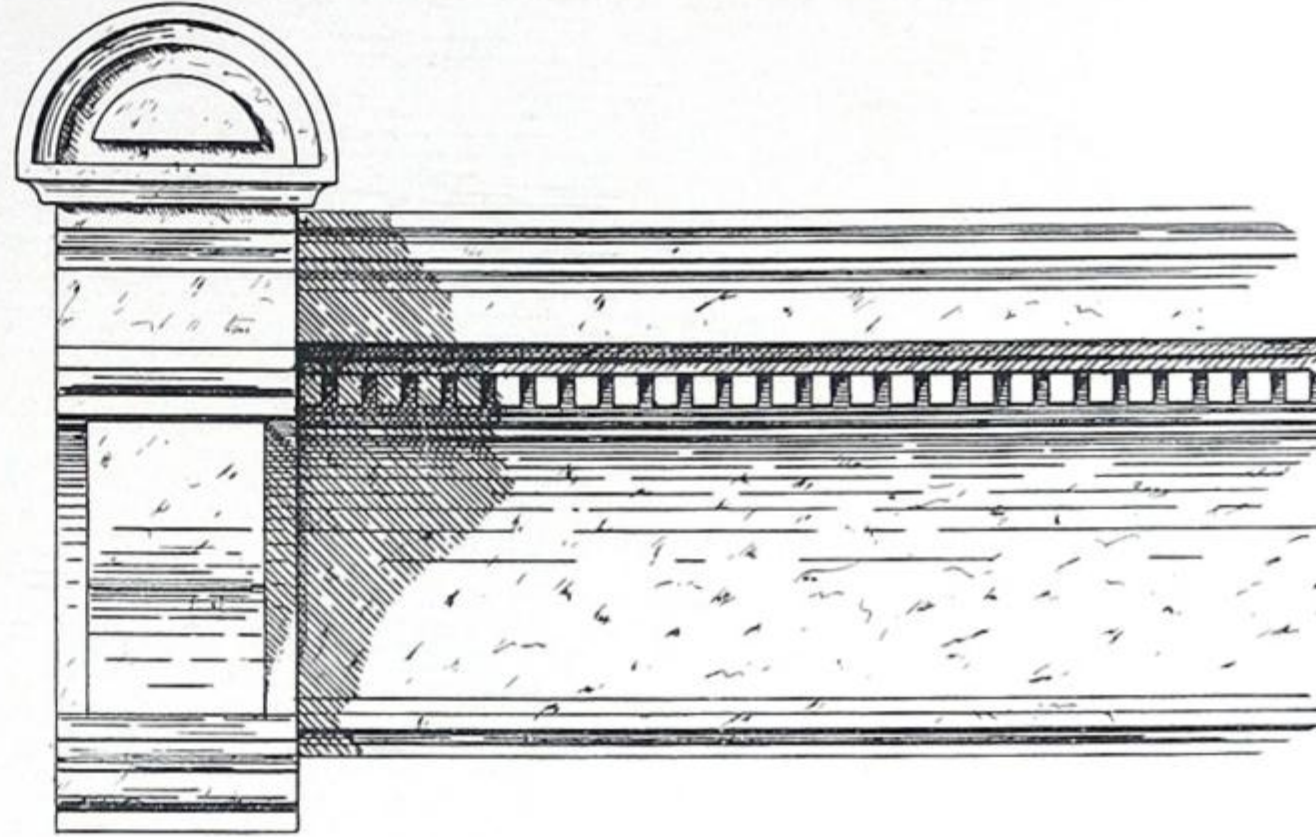
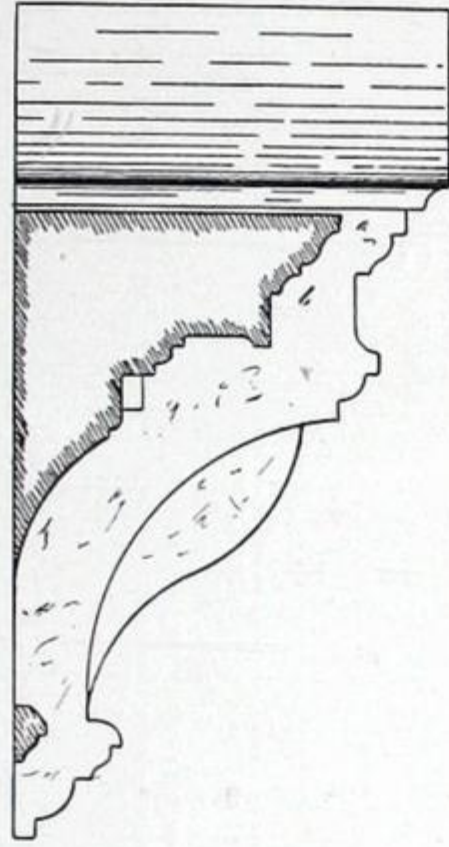

No. 1184.

Height, 30 inches.
Projection, 16 inches.
Can also be made in other sizes.

Height, 40 inches.
Projection, 20 inches.
Can also be made in other sizes.

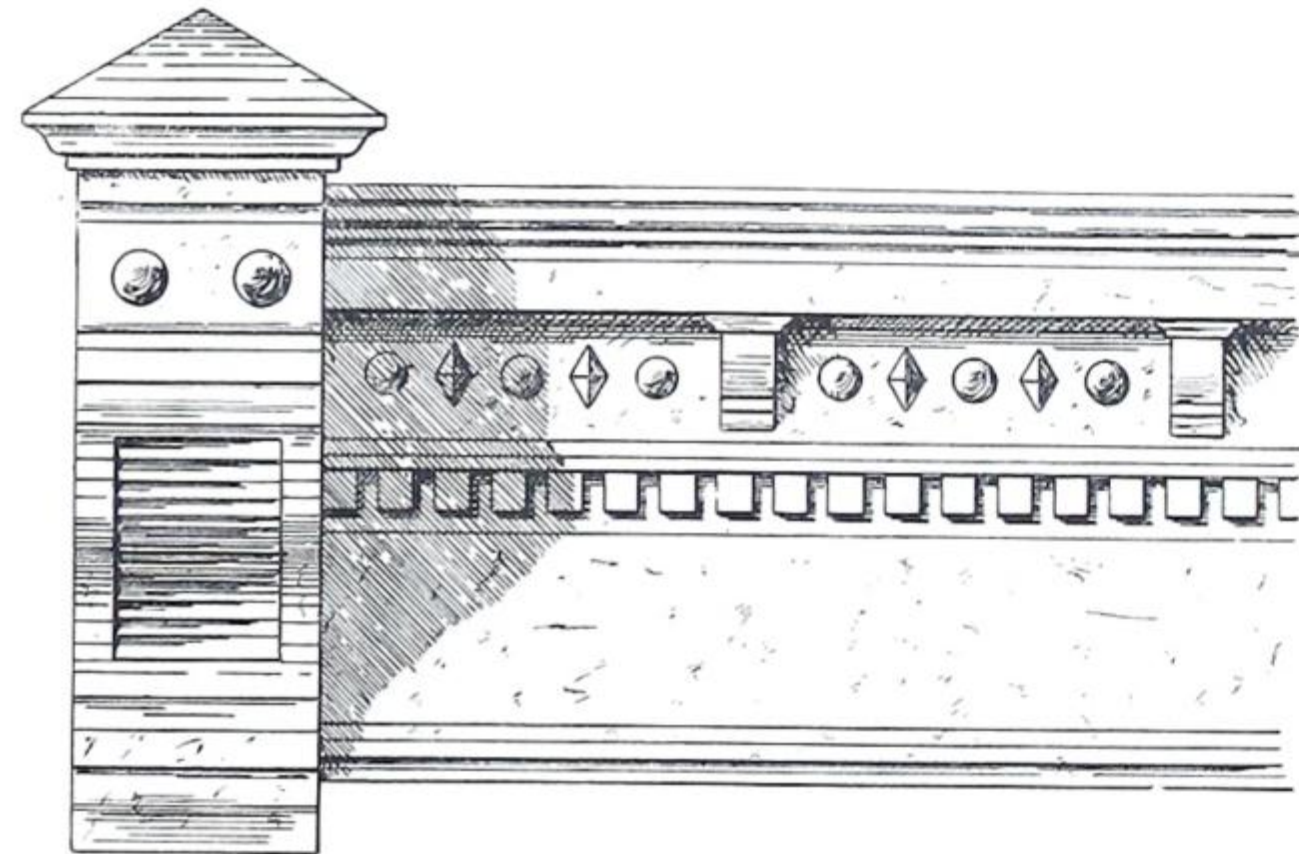
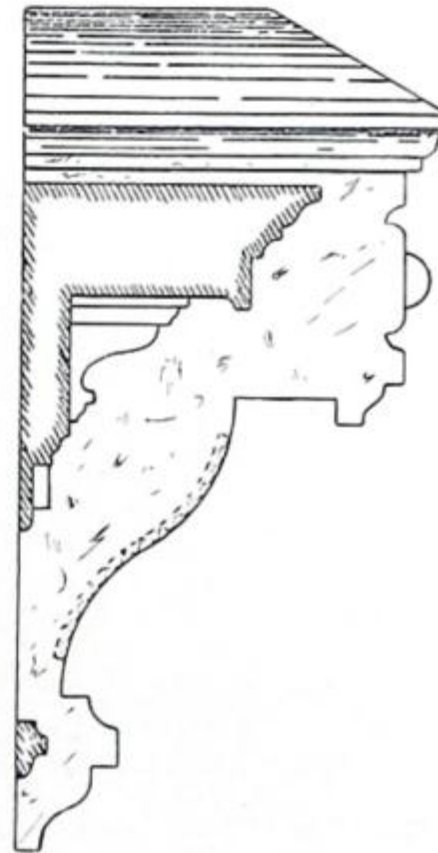

No 1185.

Metallic Cornices.

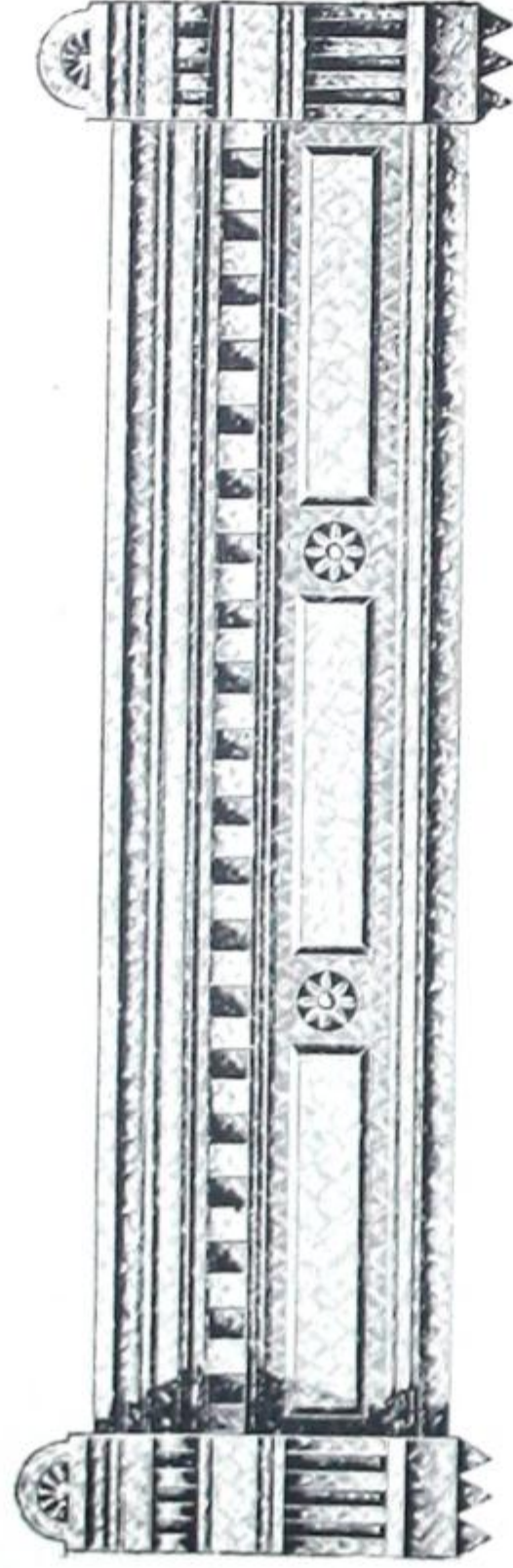

No. 1186.

Height, 48 inches ; projection, 18 inches.



No. 1187.

Height, 36 inches ; projection, 18 inches.

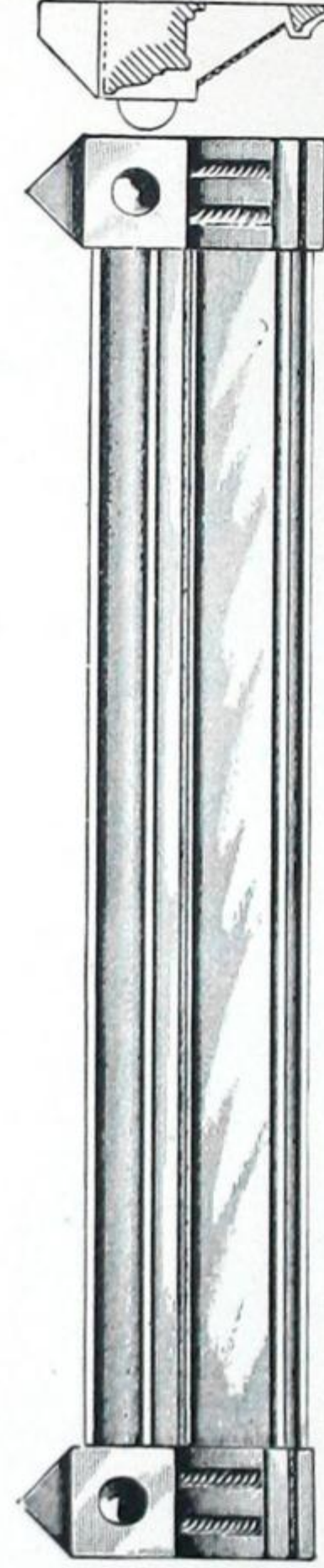

No. 1188.

Height, 24 inches ; projection, 10 inches.

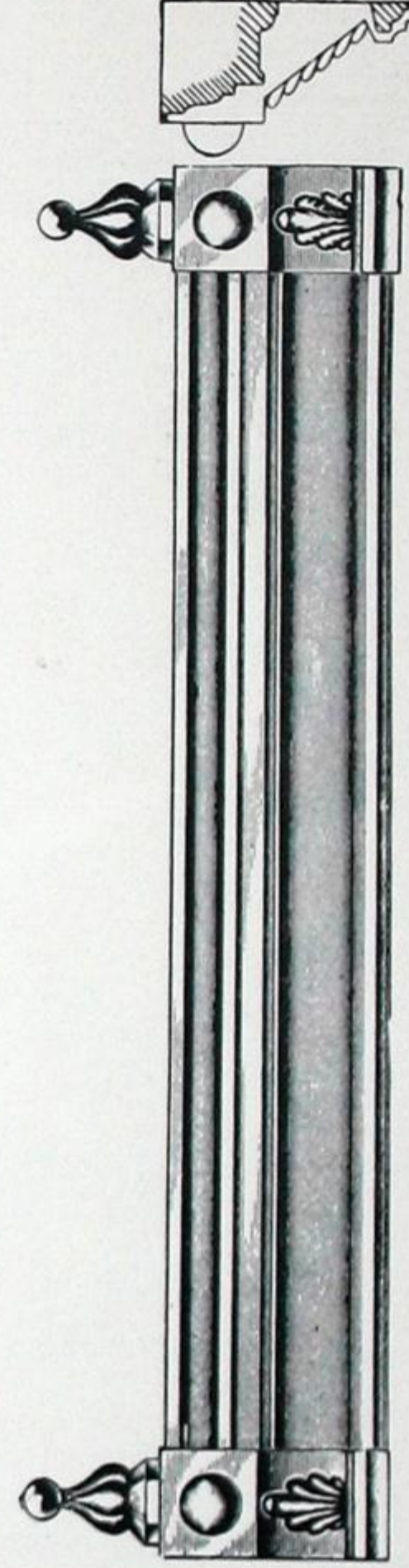

No. 1189.

Height, 24 inches ; projection, 12 inches.

Metallic Cornices.

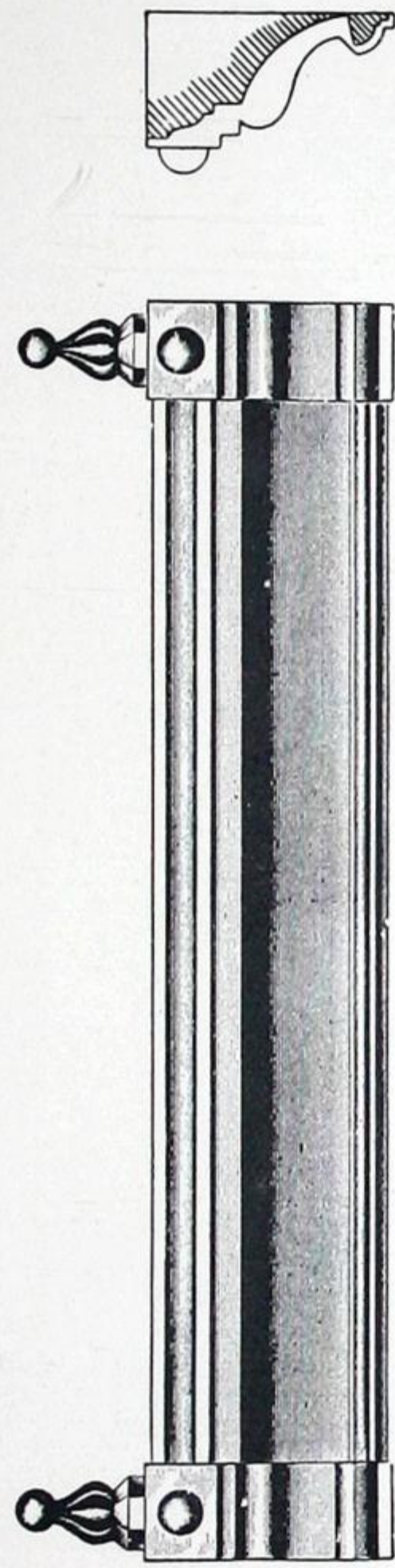

No. 1190.

Height, 28 inches ; projection, 15 inches.

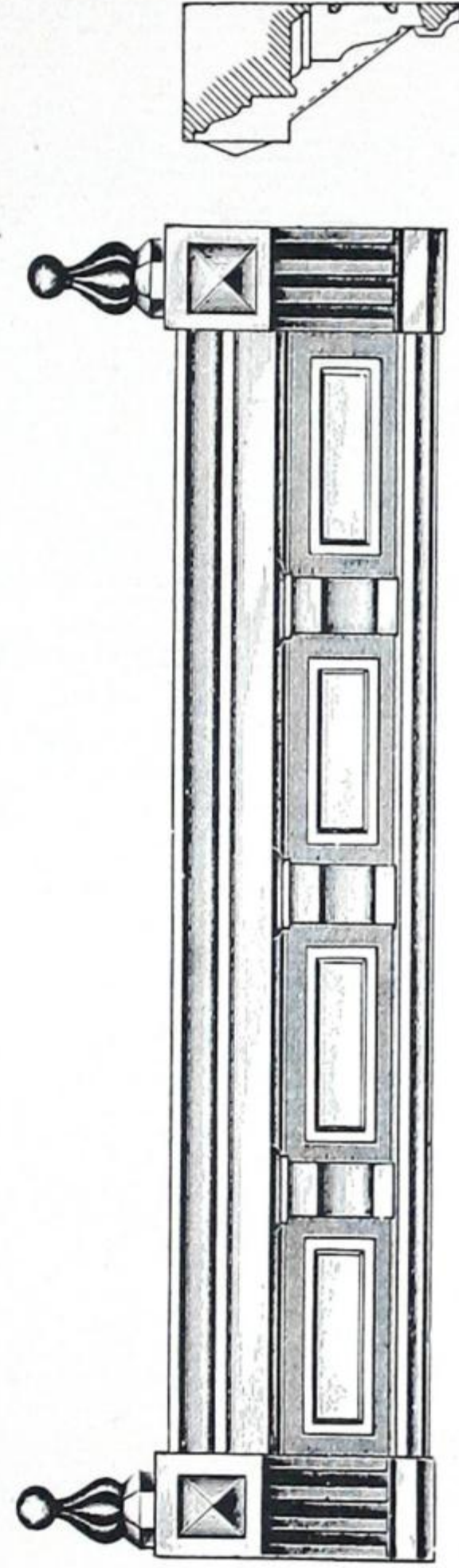

No. 1191.

Height, 30 inches ; projection, 15 inches.

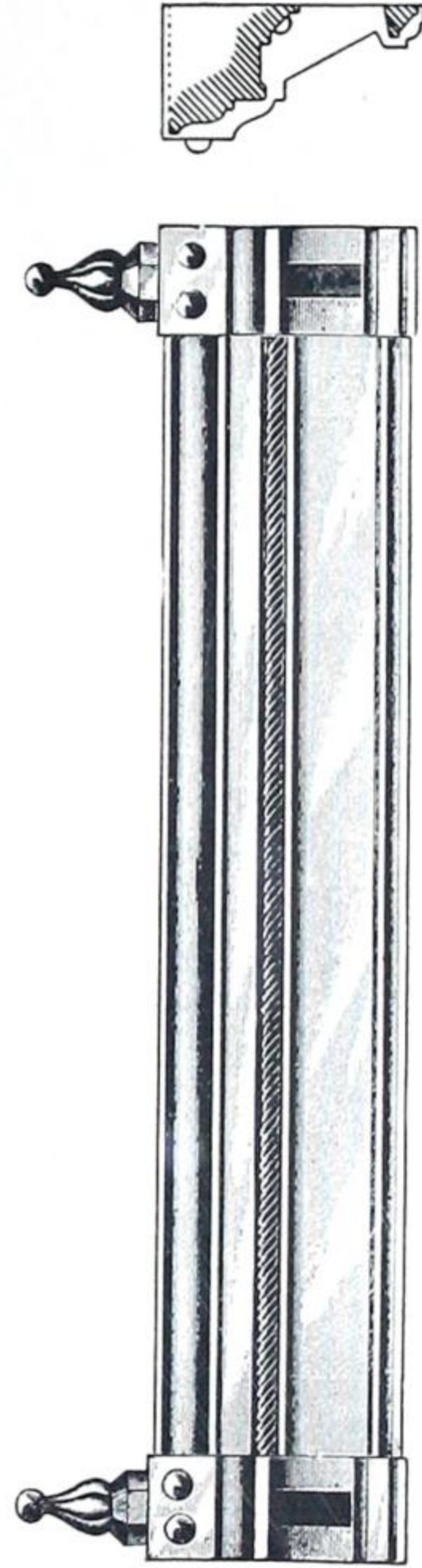

No. 1192.

Height, 28 inches ; projection, 15 inches.

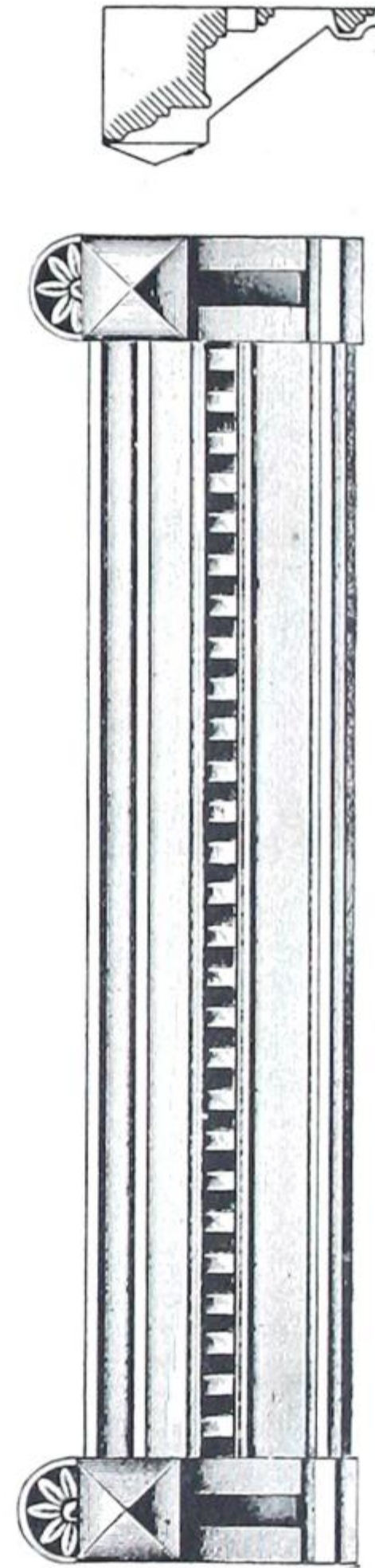

No. 1193.

Height, 30 inches ; projection, 15 inches.

Metallic Cornices.

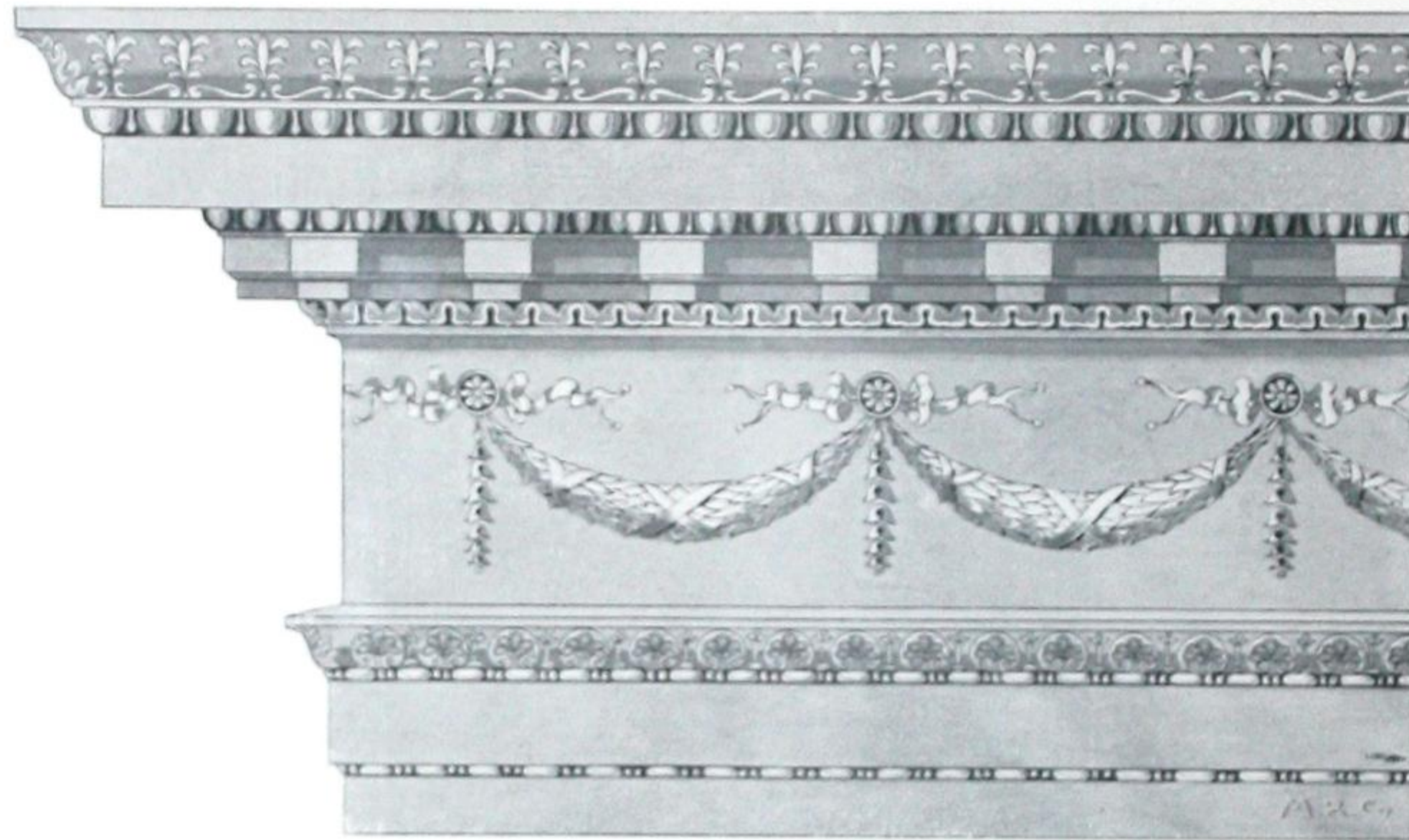

No. 1194.

Height, 72 inches ; projection, 29 inches.

Metallic Cornices.

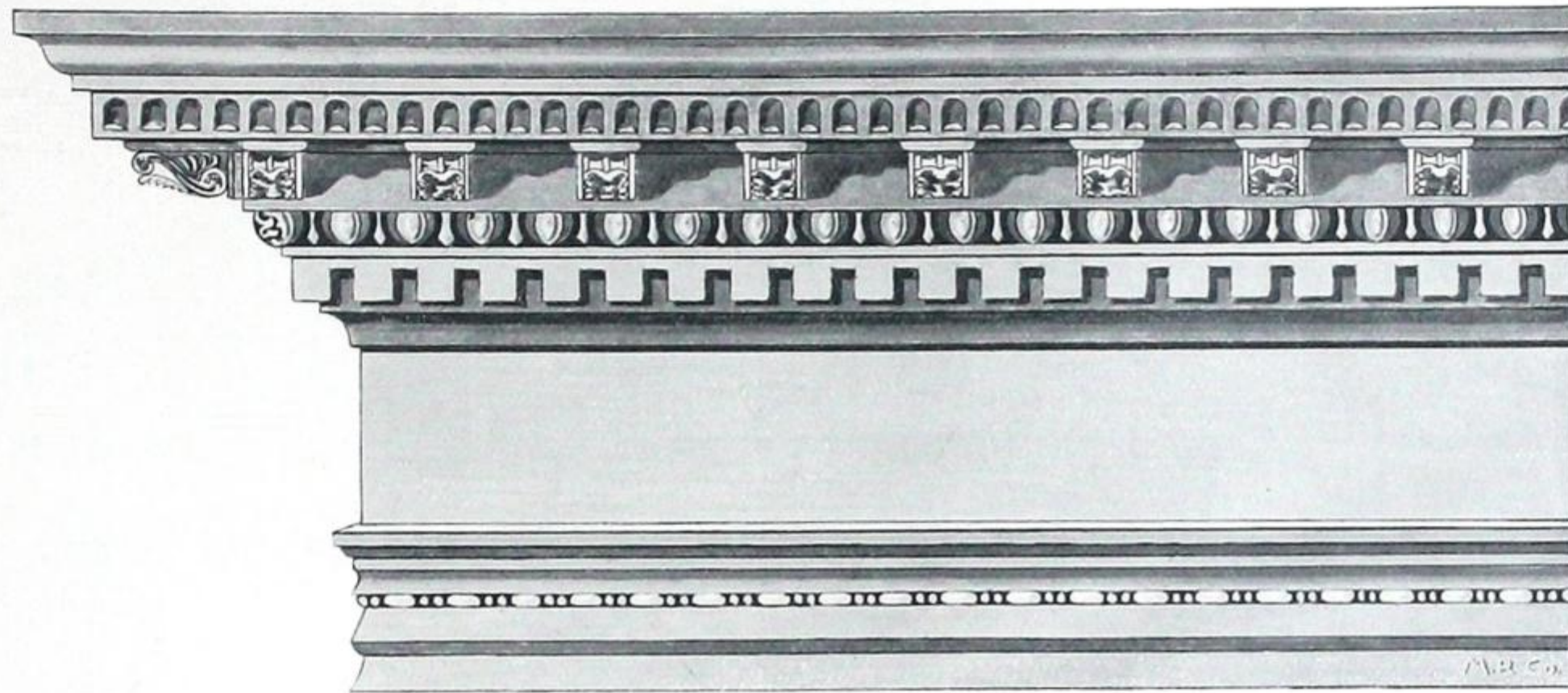

No. 1195.

Height, 52 inches ; projection, 23 inches.

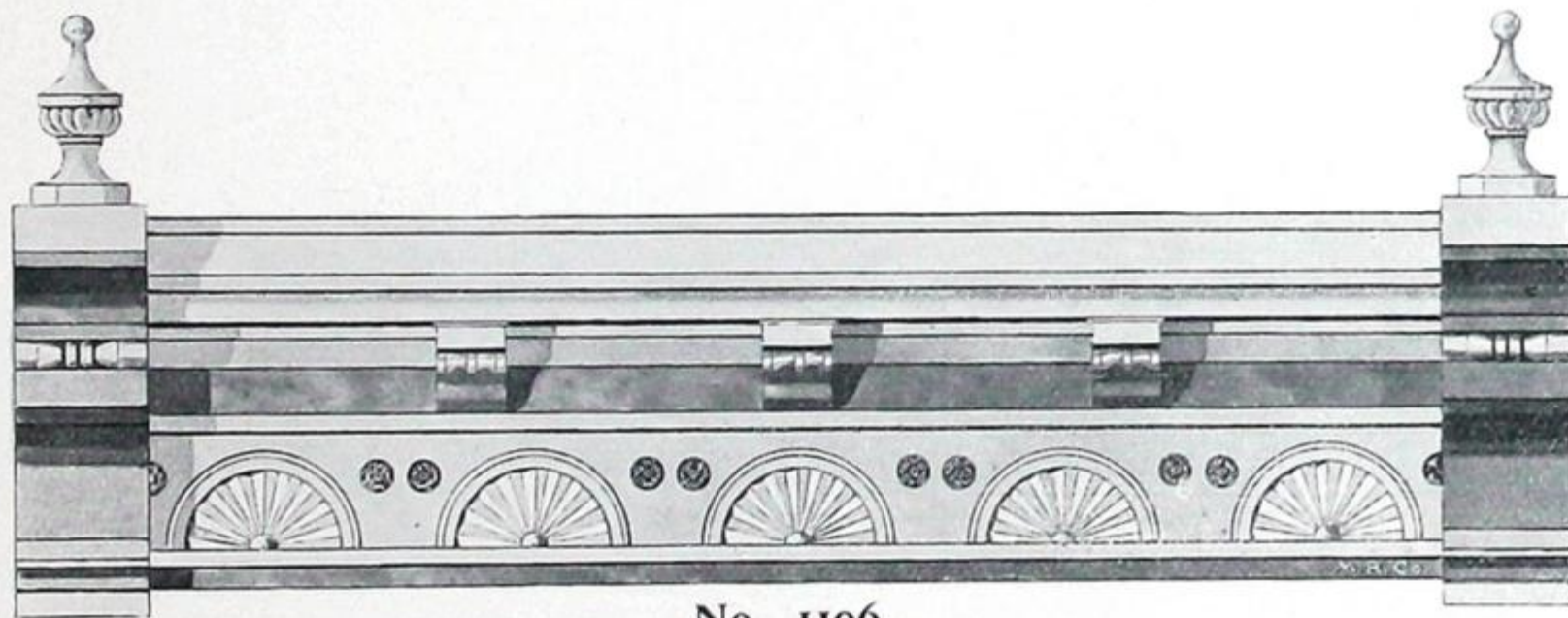

No. 1196.

Height, 36 inches ; projection, 24 inches.

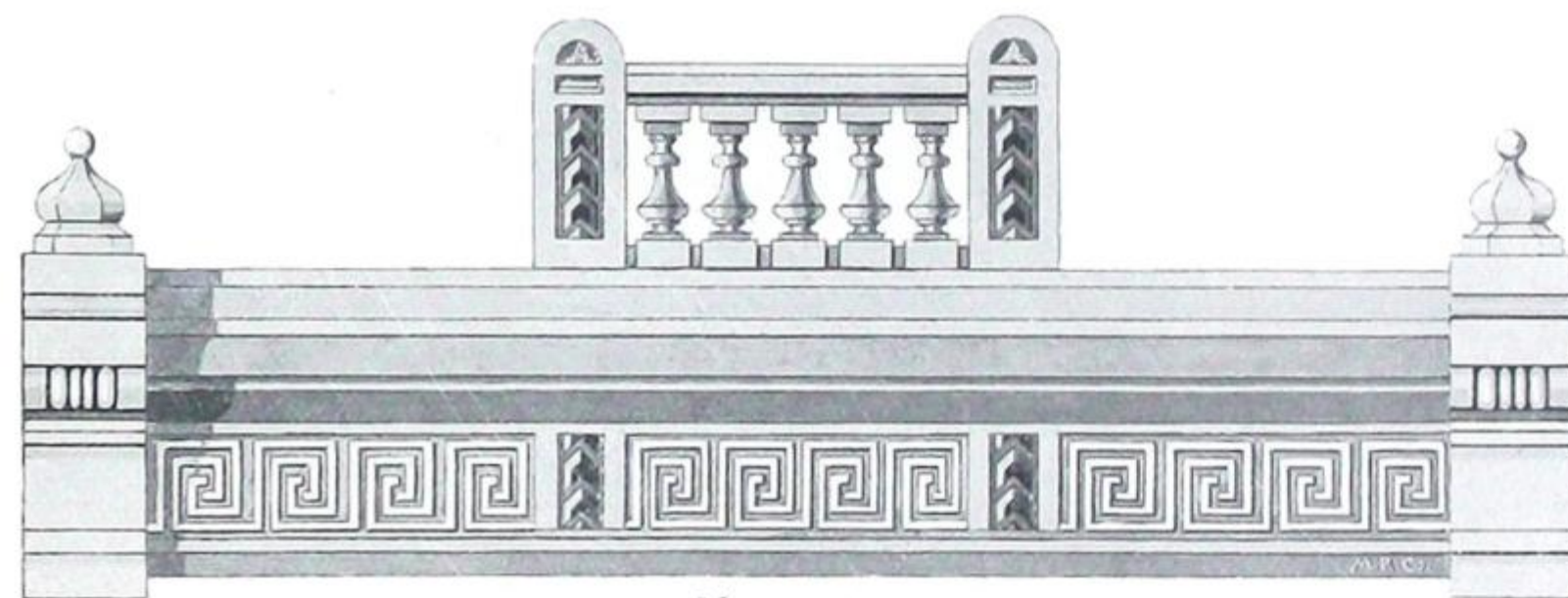

No. 1197.

Height, 30 inches ; projection 15 inches. Balustrade, 22 inches high.

THE METALLIC ROOFING COMPANY OF CANADA, LIMITED, TORONTO, CANADA.

Pediments.

Made from Galvanized Steel or Copper.

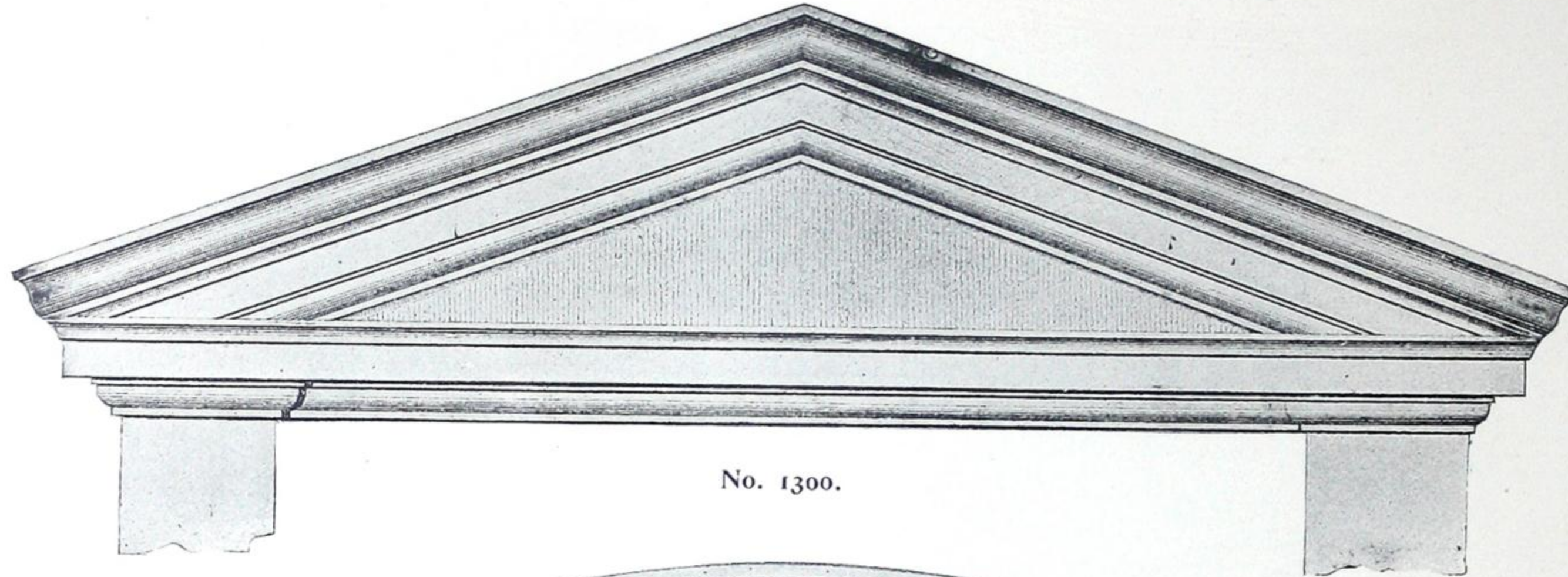

No. 1300.

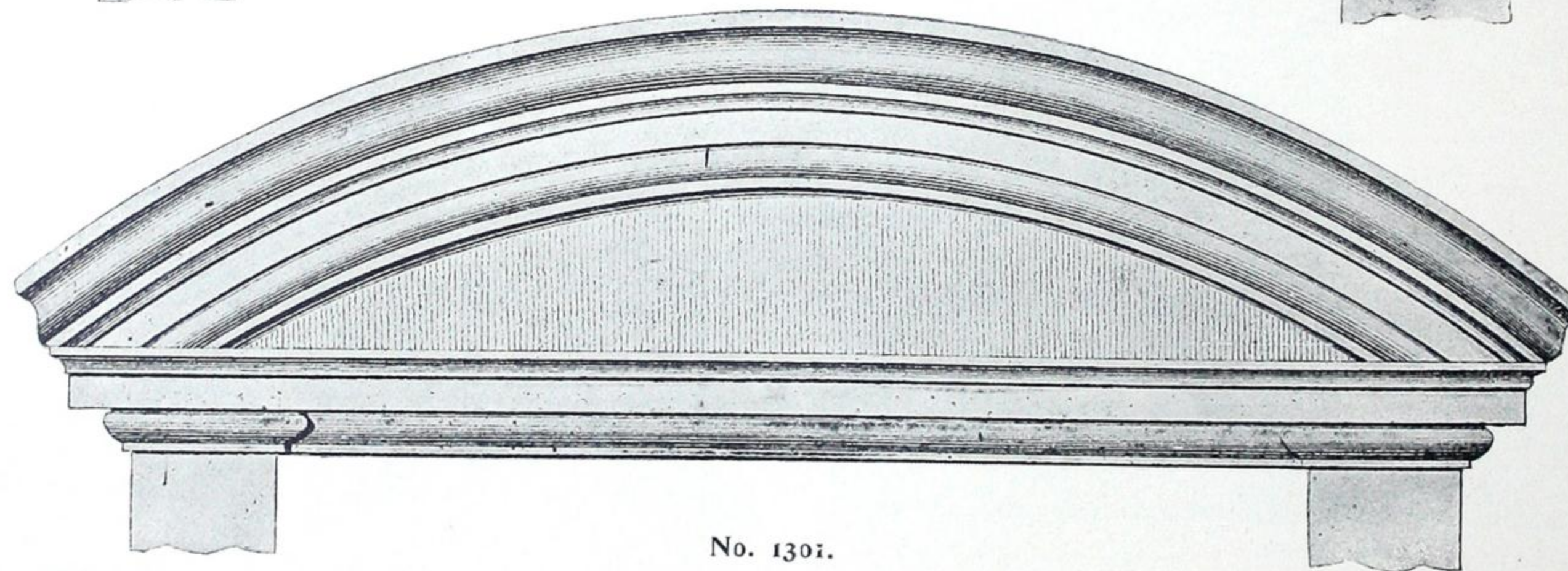

No. 1301.

In ordering give length required. No roof or back covering is sent unless specially mentioned, simply the face as shown, with not exceeding 18-inch return at each end. Any size or design can be made.

**Dormer
and
Mansard
Windows.**

Made from Galvanized Steel or
Copper.

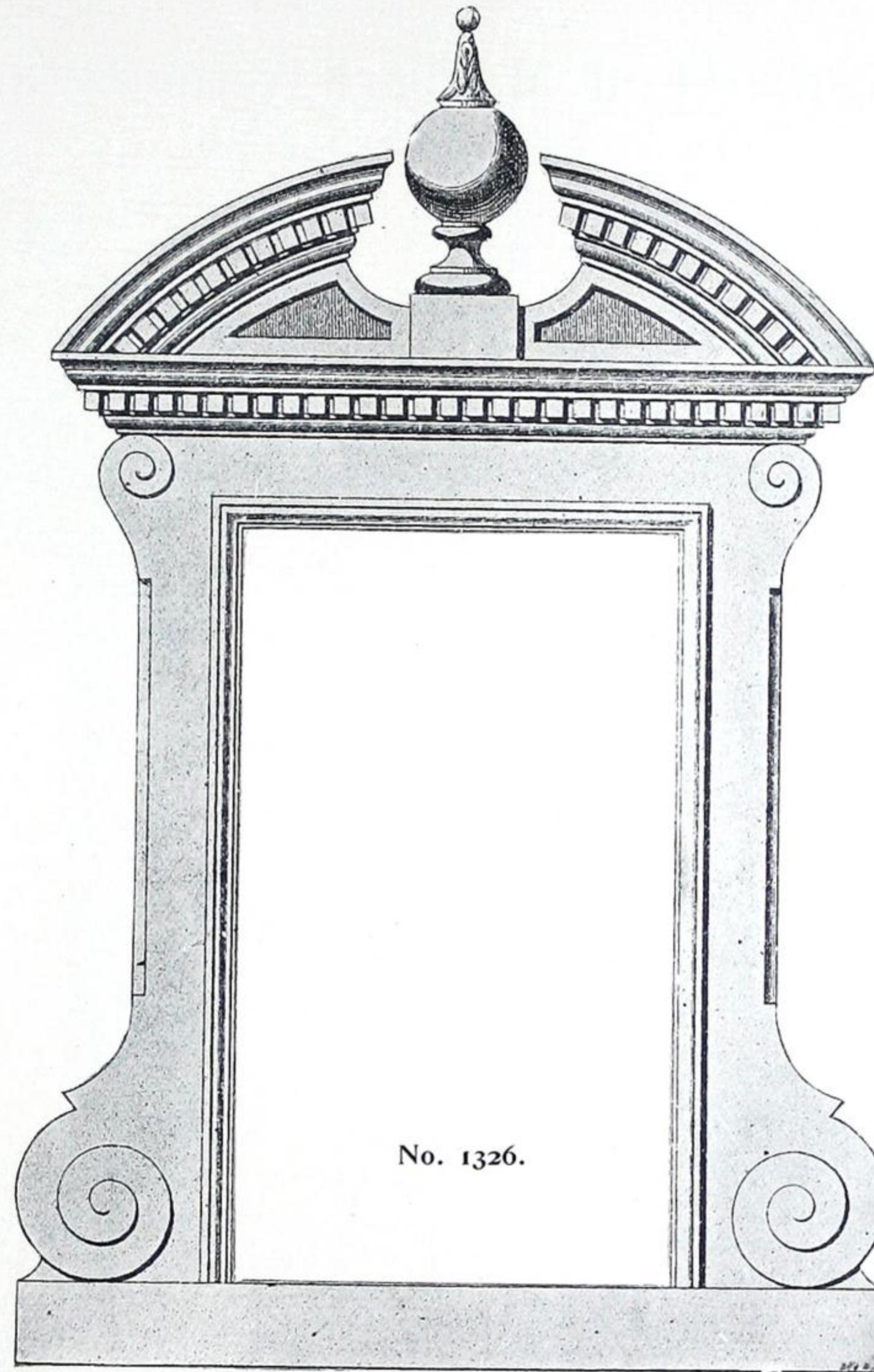

We supply face only as shown.
No woodwork, sash or glass.
No roof or covering for sides,
where window projects, is sent unless
specially ordered.

Any size or design can be made.

THE METALLIC ROOFING COMPANY OF CANADA, LIMITED, TORONTO, CANADA.

Dormer and Mansard Windows.

Made from Galvanized Steel, or Copper.

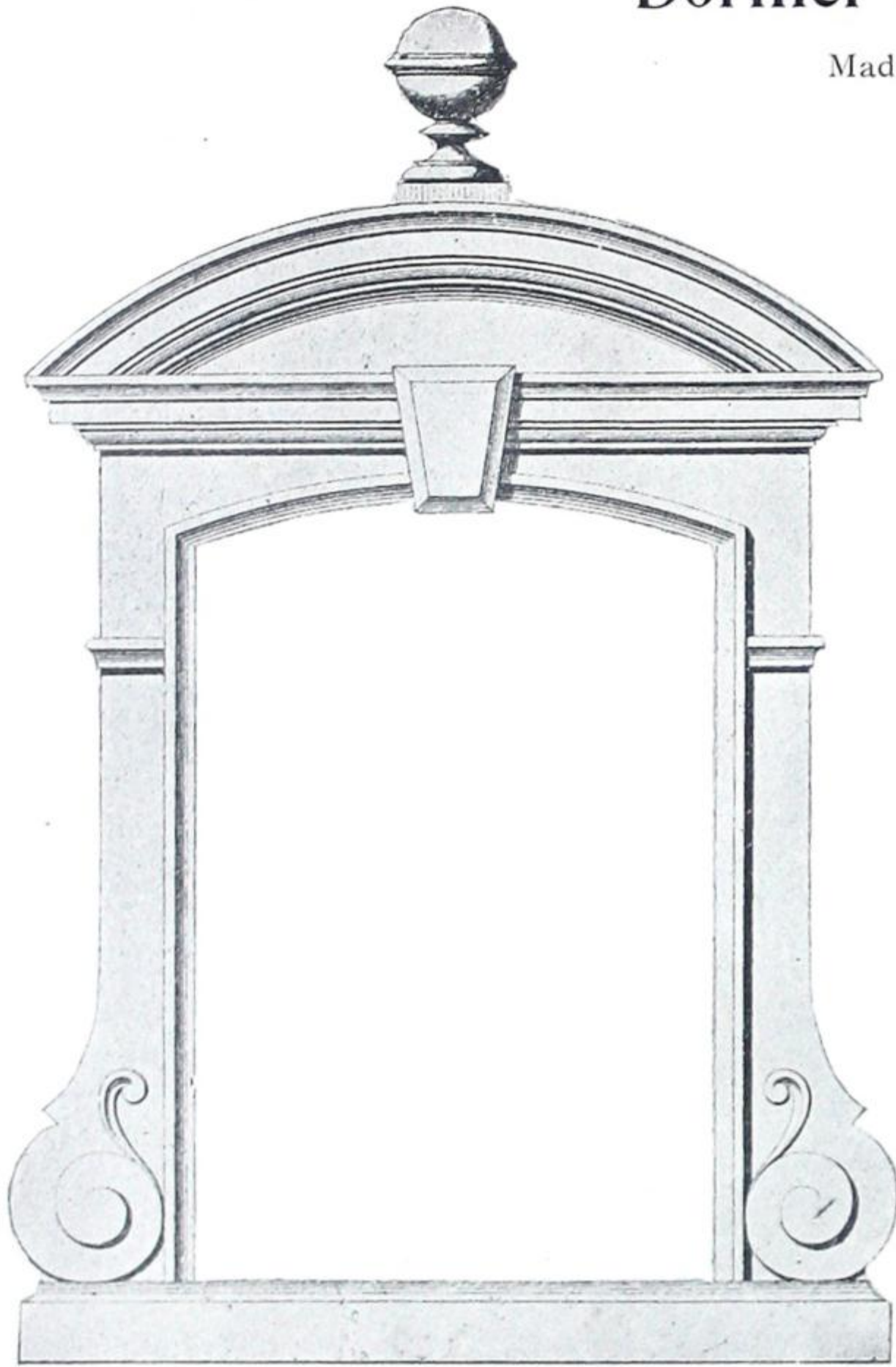

No. 1327.

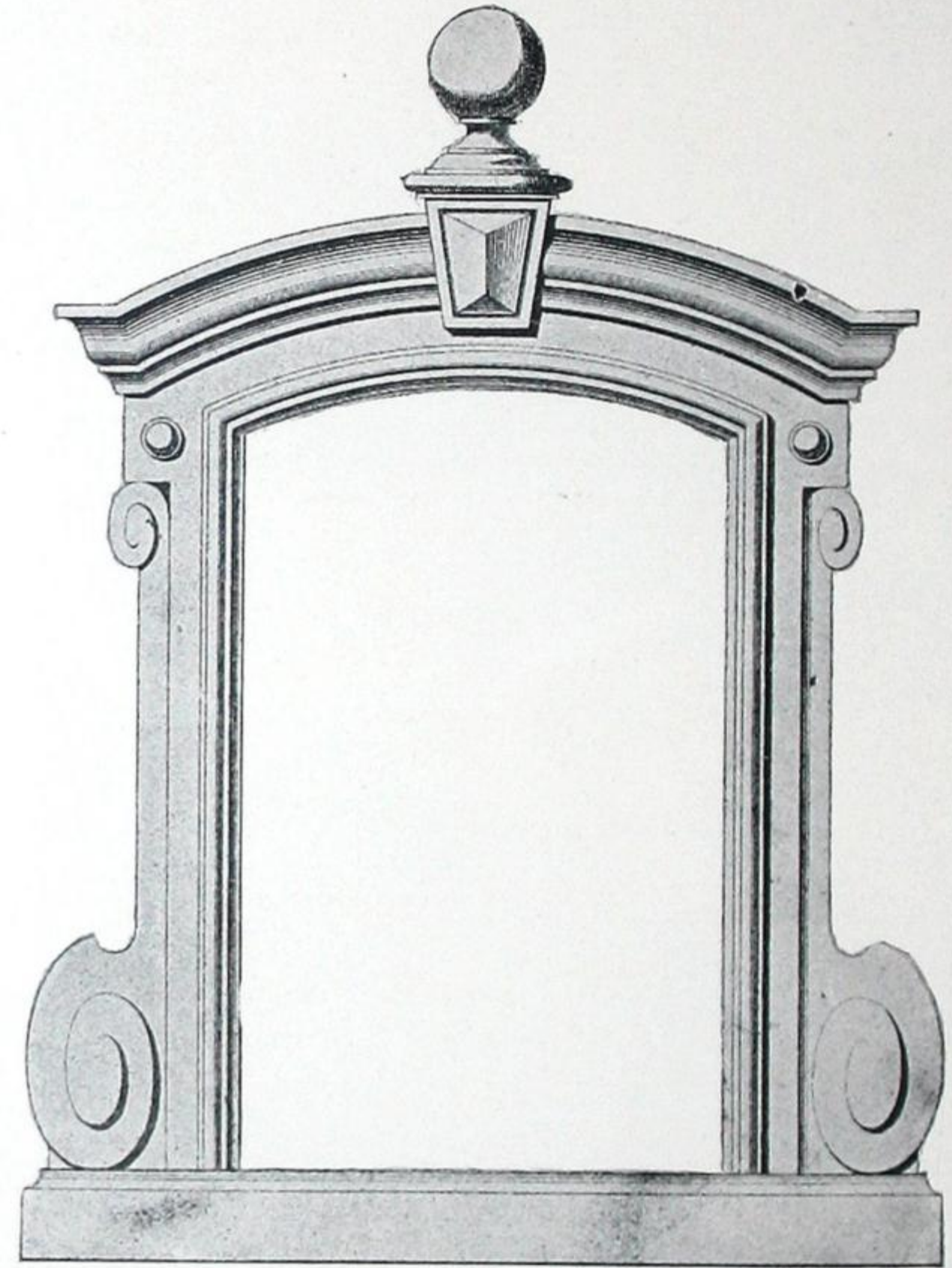

No. 1328.

We supply face only as shown, no woodwork, sash, or glass. No roof or covering for sides, where windows project, is sent unless specially ordered. Any size or design can be made.

THE METALLIC ROOFING COMPANY OF CANADA, LIMITED, TORONTO, CANADA.

Dormer and Mansard Windows.

Made from Galvanized Steel, or Copper.

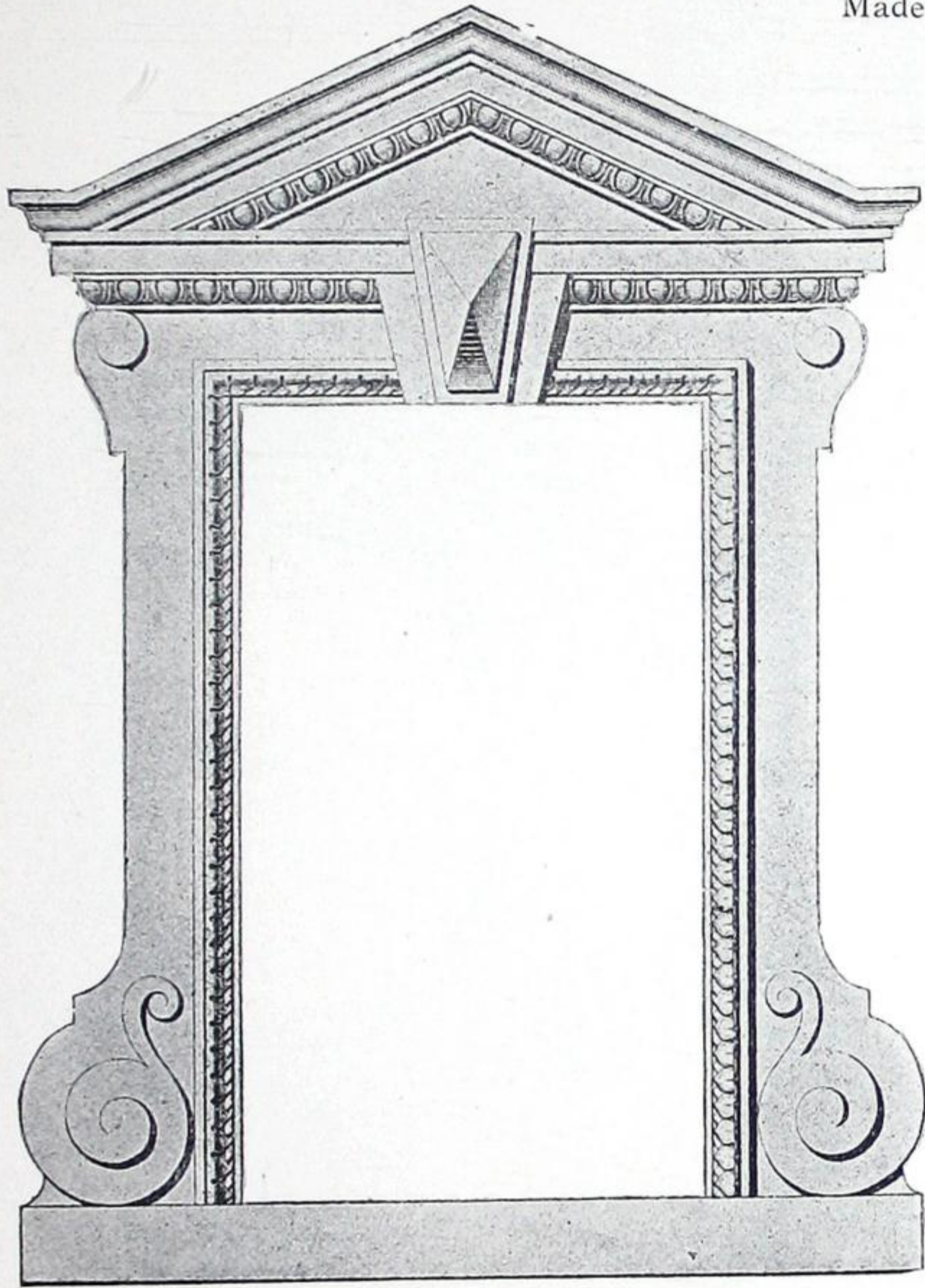

No. 1329.

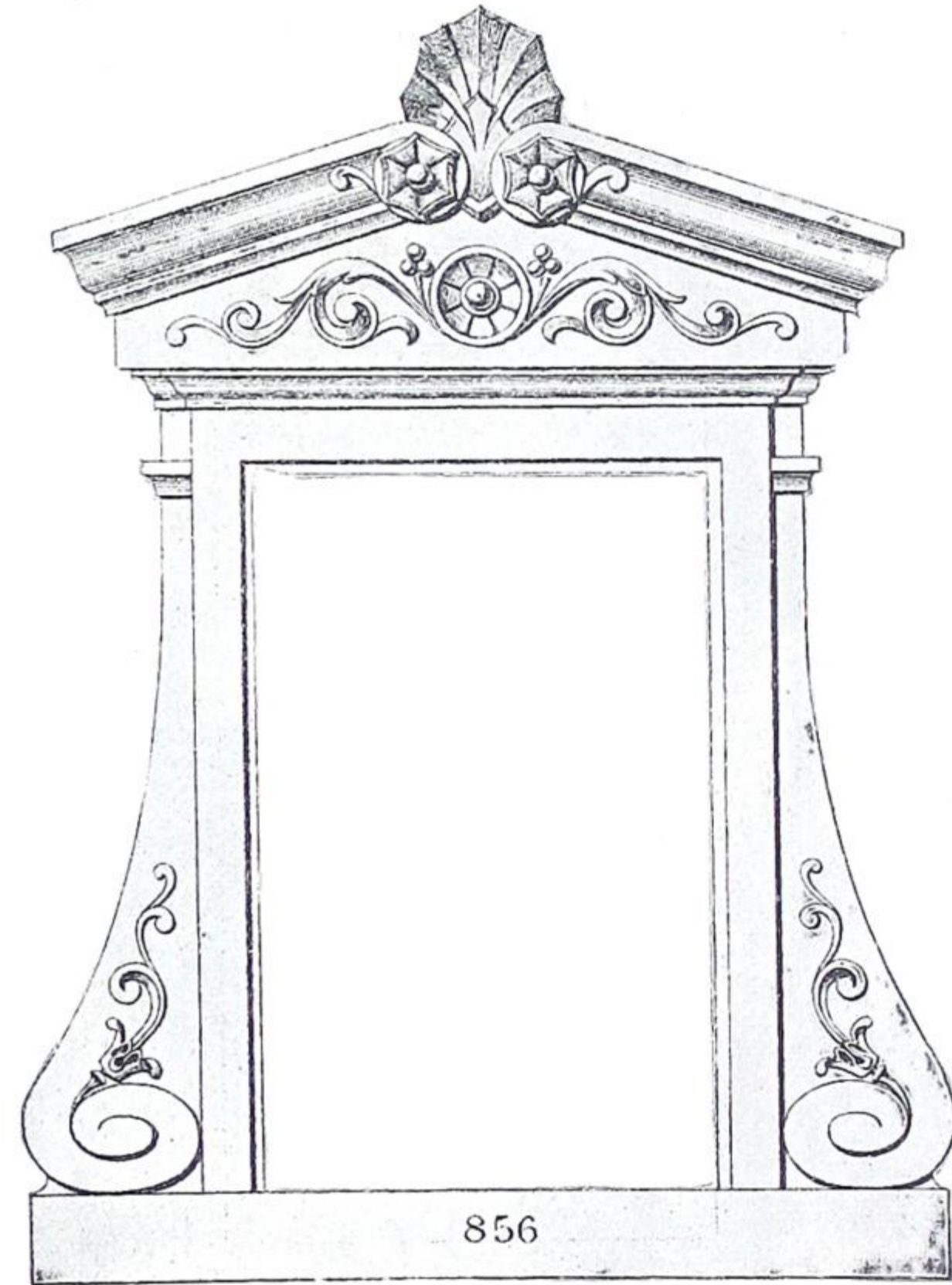

No. 1330.

We supply face only as shown, no woodwork, sash, or glass. No roof or covering for sides, where windows project, is sent unless specially ordered. Any size or design can be made.

THE METALLIC ROOFING COMPANY OF CANADA, LIMITED, TORONTO, CANADA.

Dormer and Mansard Windows.

Made from Galvanized Steel or Copper.

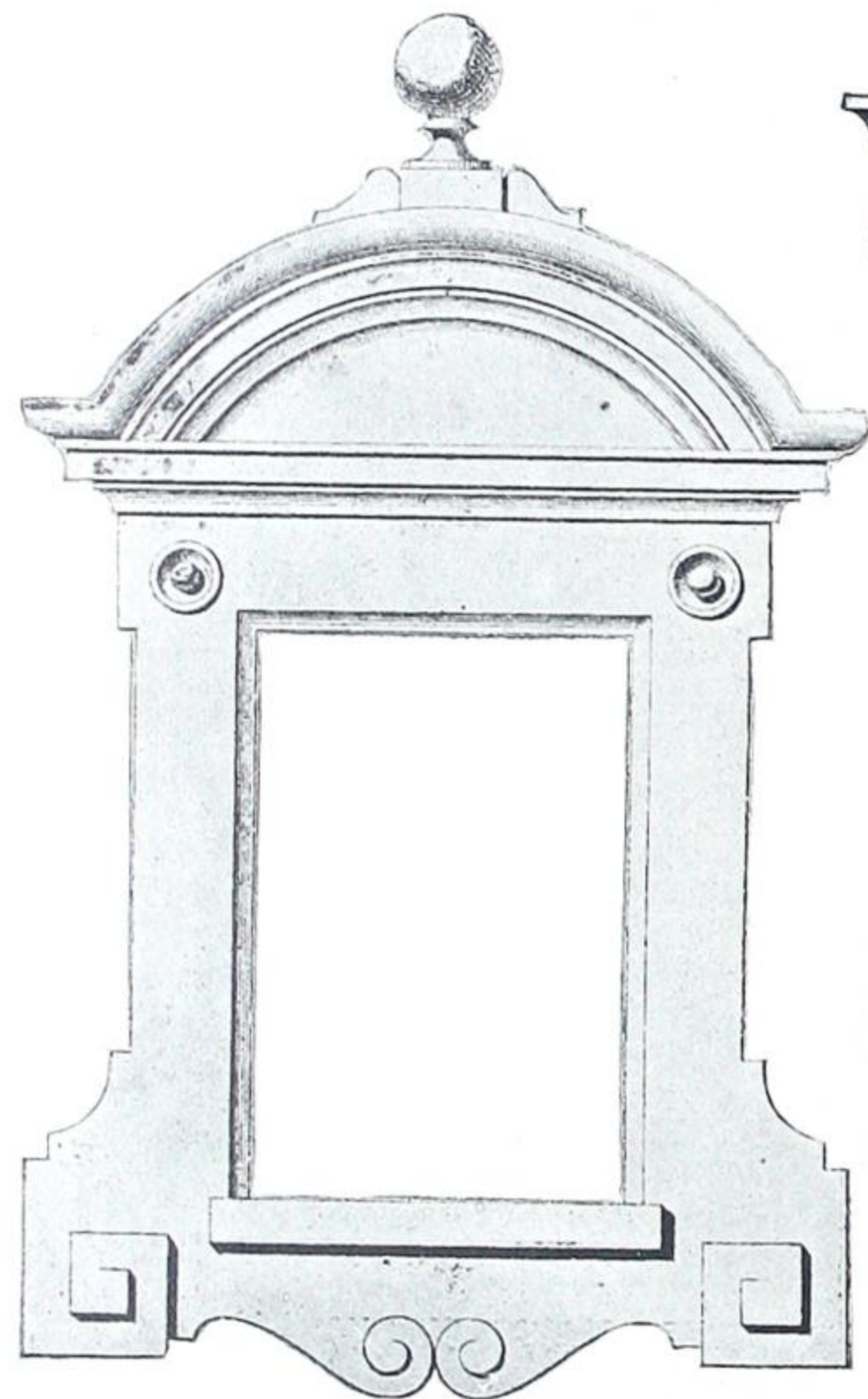

No. 1331.



No. 1334

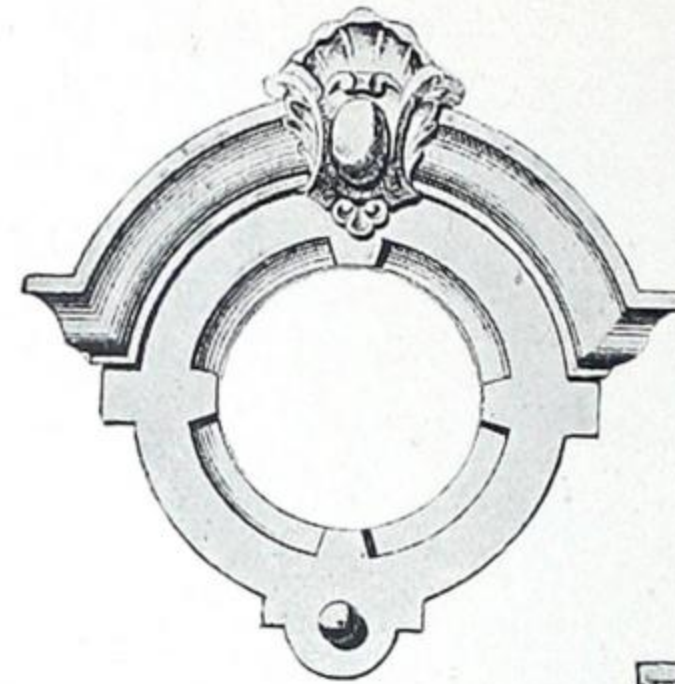

No. 1335.

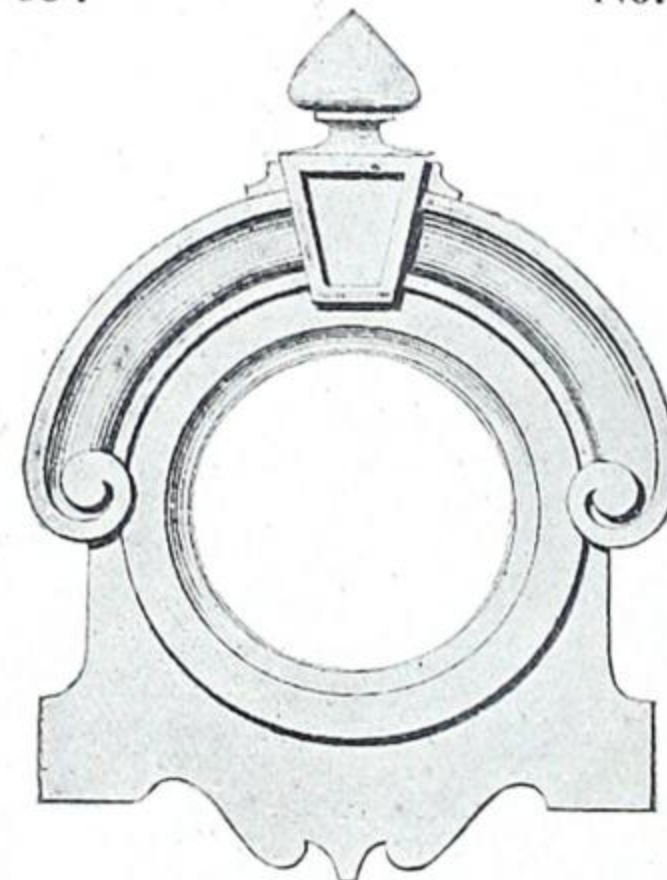

No. 1333.

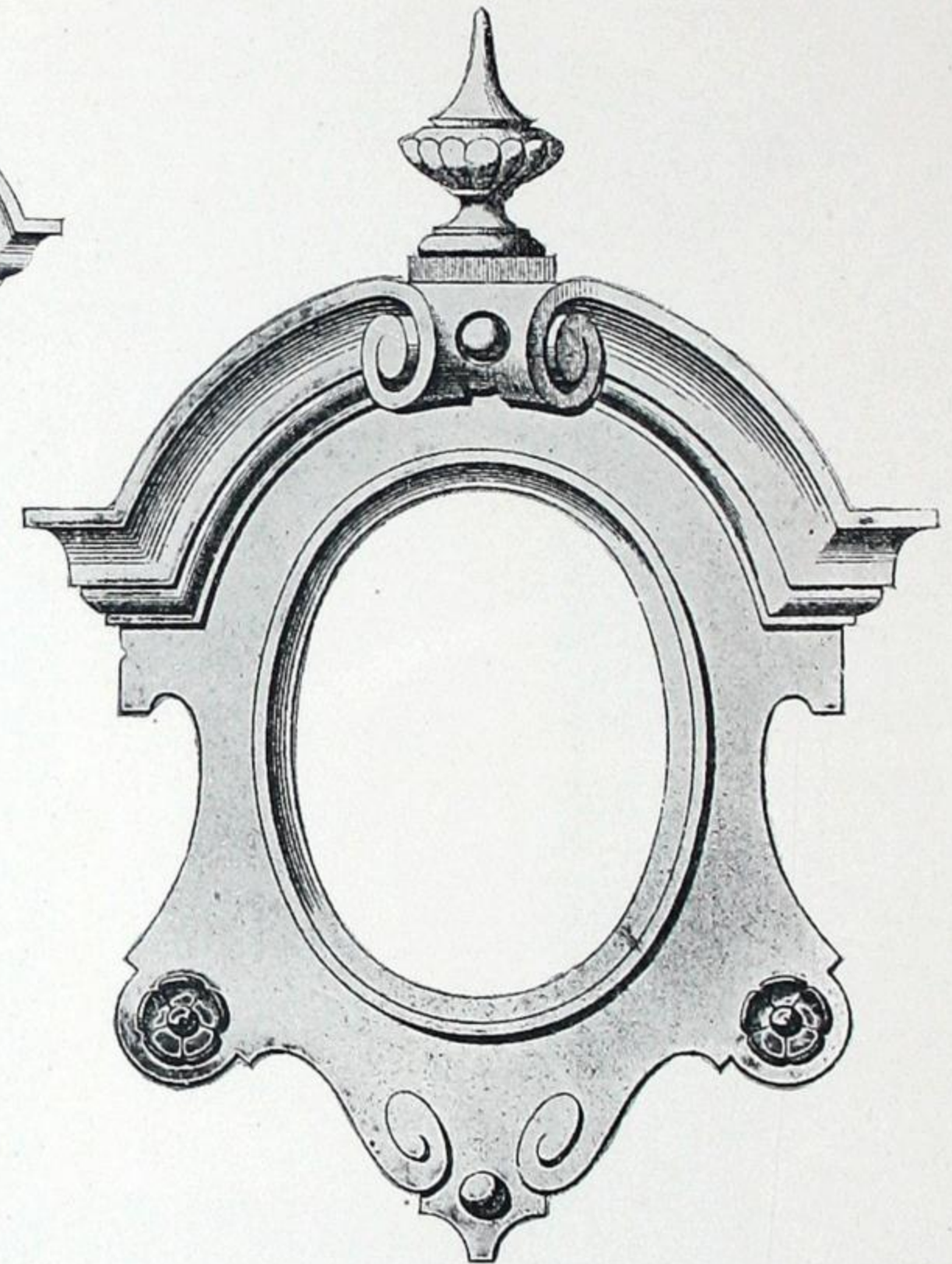

No. 1332.

We supply face only as shown, no woodwork, sash or glass. No roof or covering for sides, where windows project, is sent unless specially ordered.
Any size or design can be made.

Octagonal Bay Window.

Made from Galvanized Steel, or
Copper.



No. 1336.

This design can also be used for
square windows.

Prices quoted on receipt of speci-
fication of shape and size required.

Any size or design can be made.

Oriel Window.

Made from Galvanized Steel, or Copper.

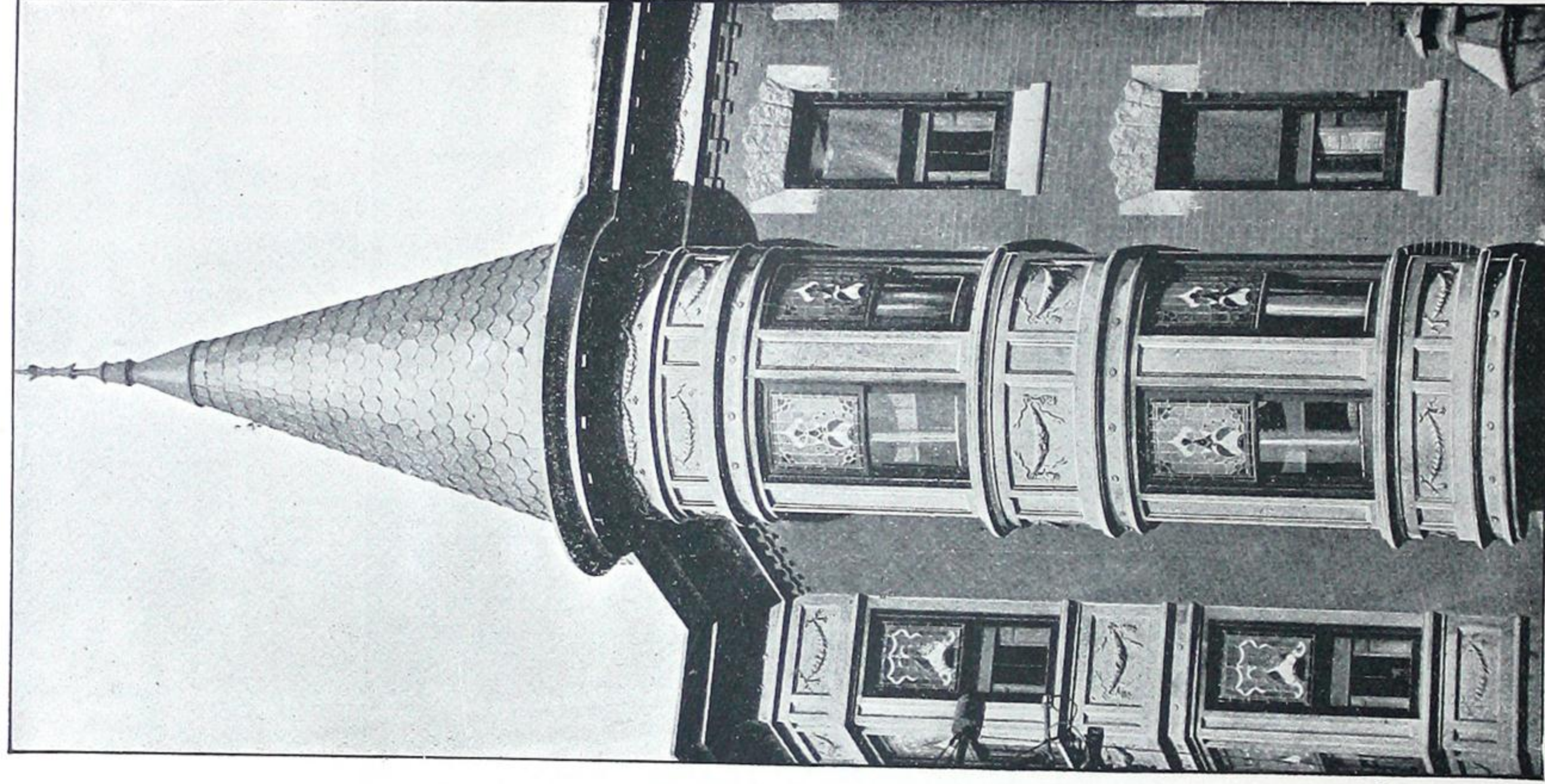

No. 1337.

Prices quoted on receipt of specification of size and shape required.

Any size or design can be made.

Door and Window Caps.

Made from Galvanized Steel or Copper.

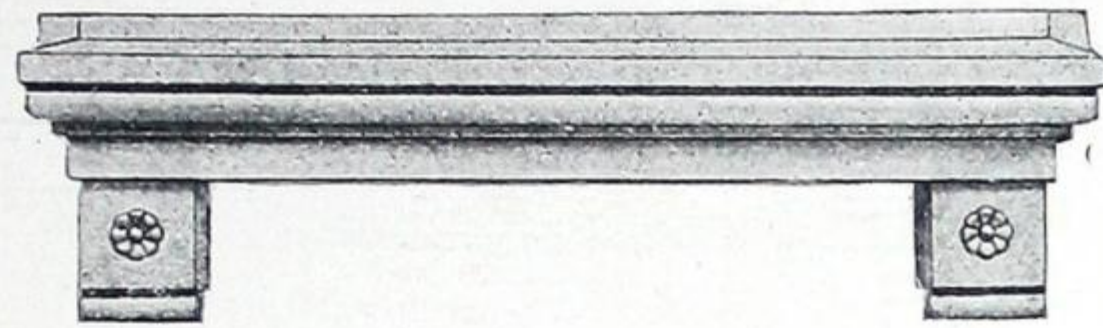

No. 1400.

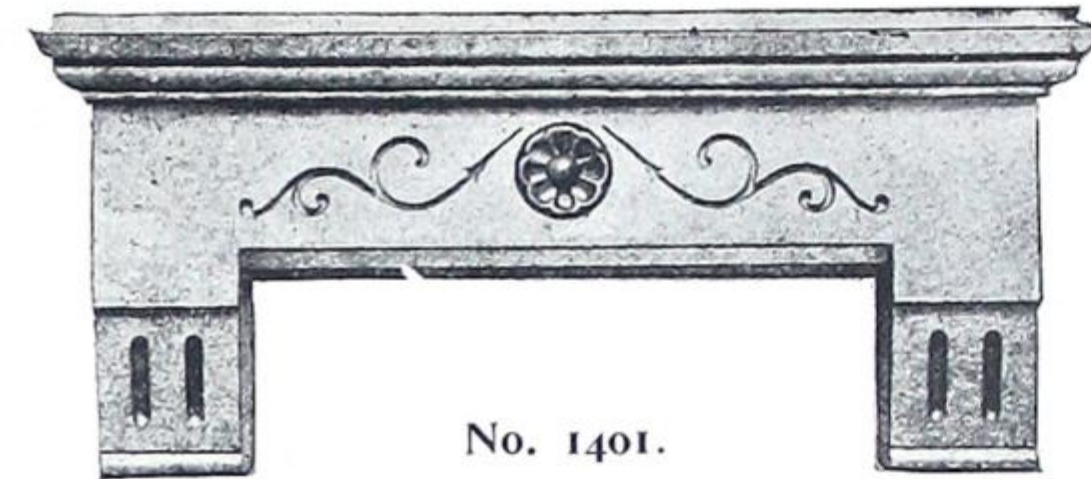

No. 1401.

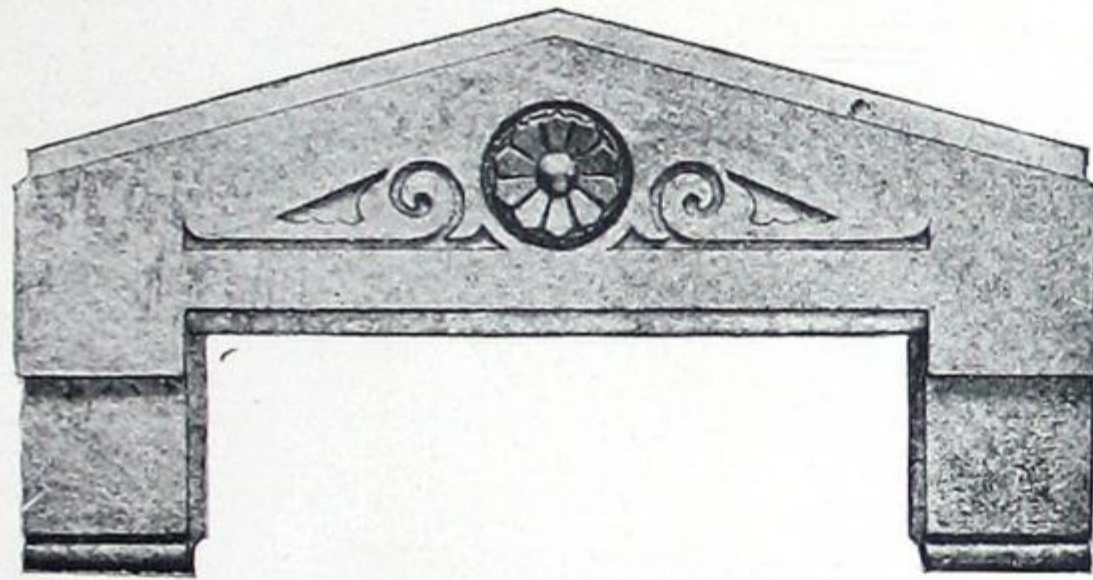

No. 1402.

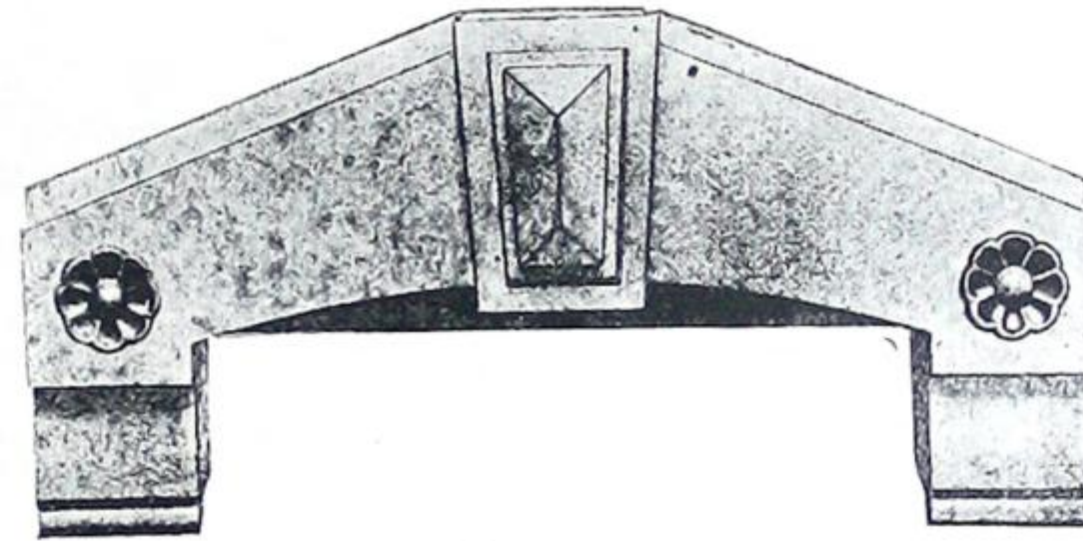

No. 1403.

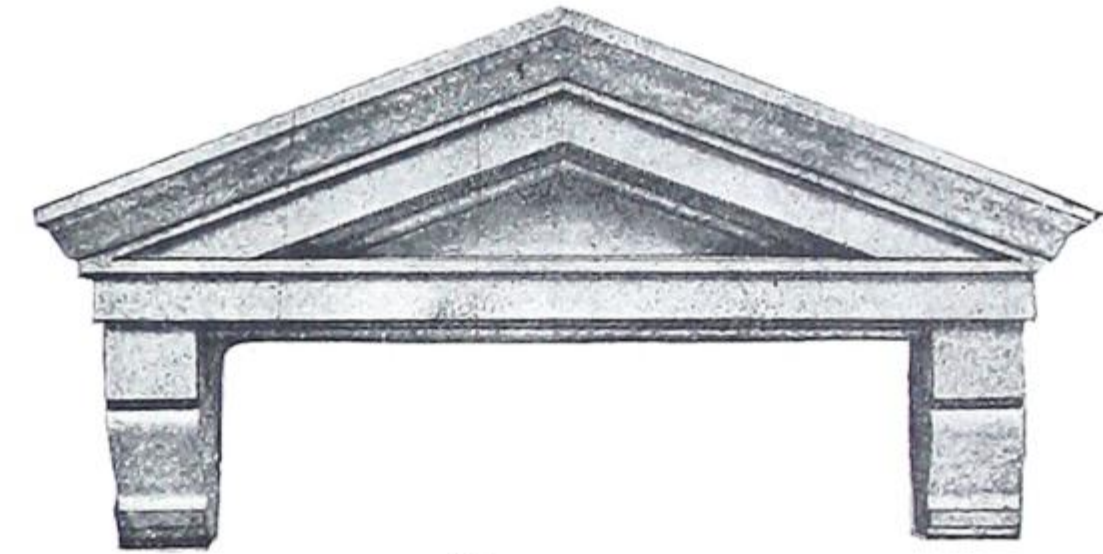

No. 1404.

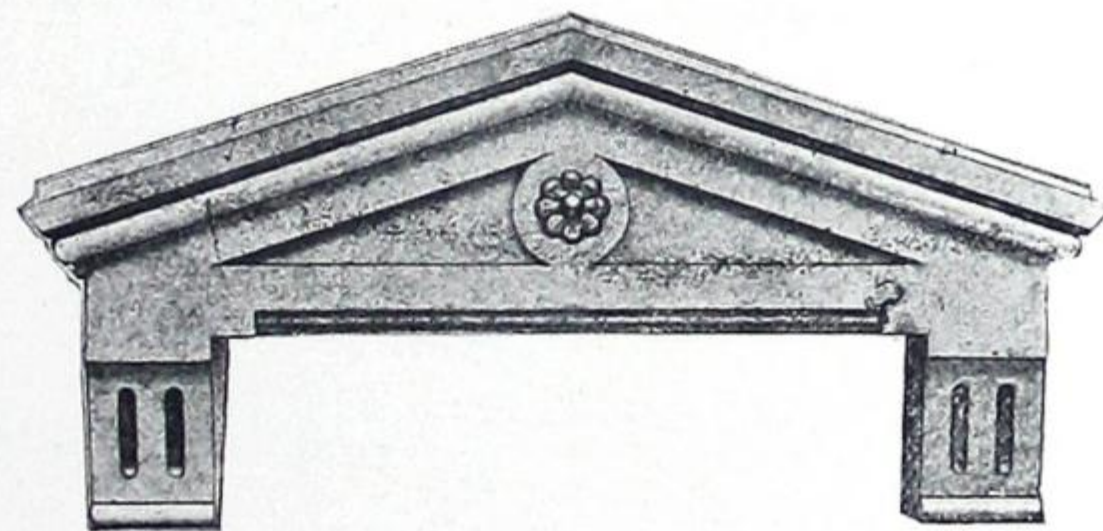

No. 1405.

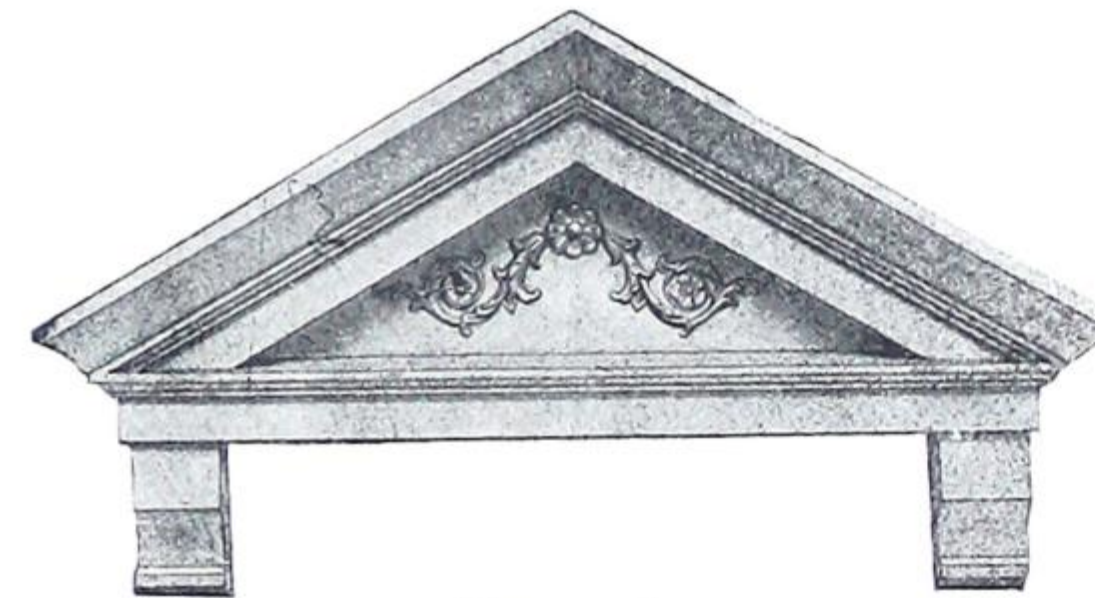

No. 1406.

In ordering give exact width of opening, and always state if caps are to be built in brickwork, or to be put on a building already erected.
Any size or design can be made.

Door and Window Caps.

Made from Galvanized Steel or Copper.

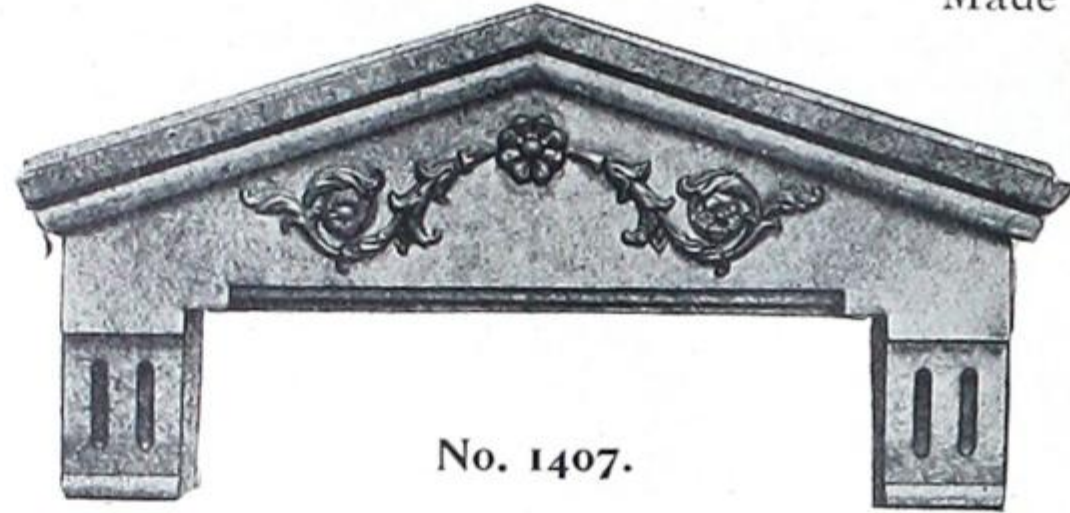

No. 1407.

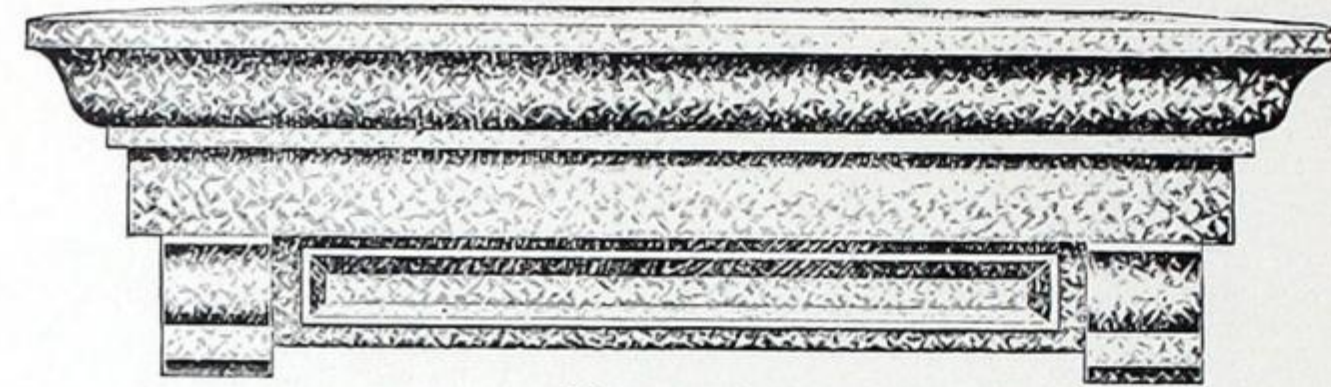

No. 1408.



No. 1409.



No. 1410.



No. 1411.

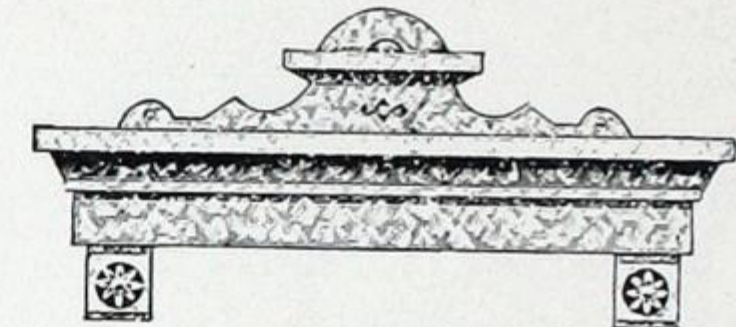

No. 1412.

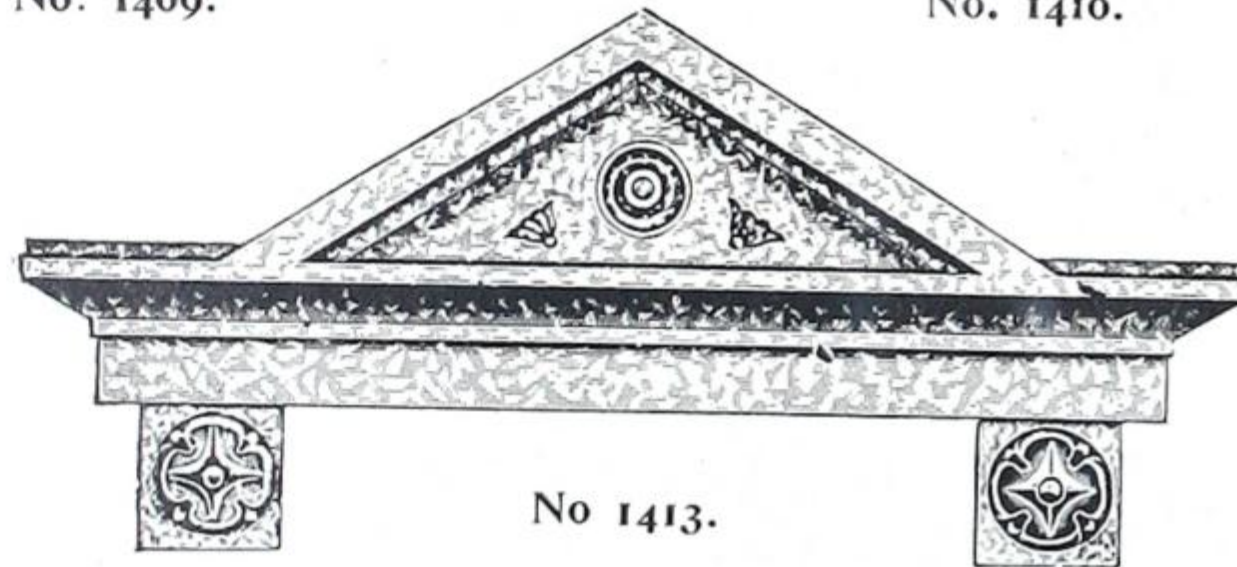

No. 1413.



No. 1414.



No. 1415.



No. 1416.



No. 1417.



No. 1418.

In ordering, give exact width of opening, and state if caps are to be built in brickwork, or to be put on a building already erected. For circular heads give width of opening, height of face, and radius of the arch. For straight rock-faced heads give exact length, face and projection required.

Metallic Sills.

Made from Galvanized Steel, or Copper.

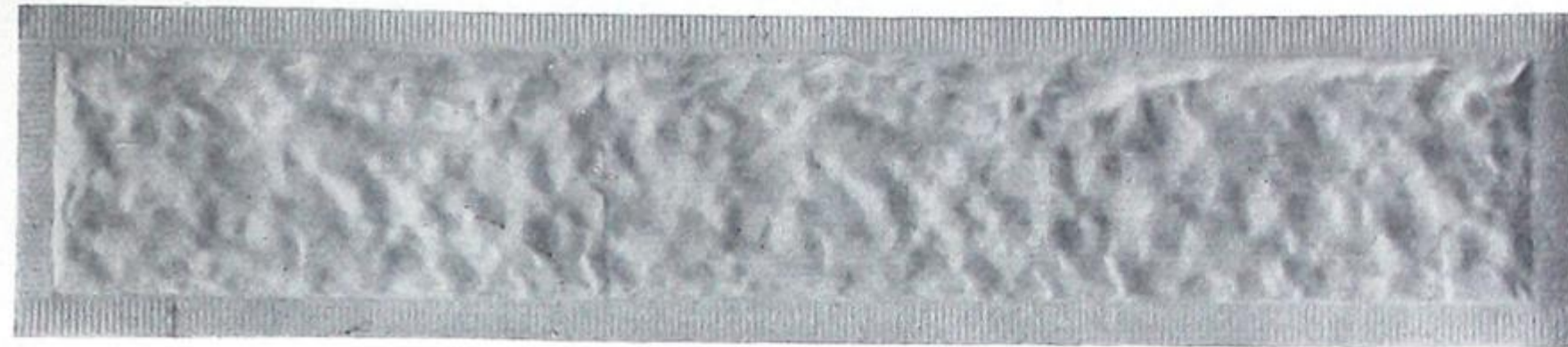

No. 1450.

Rock-faced, with chisel draft. 6, 8, 10 and 12-inch rock-face, with any size of chisel draft.

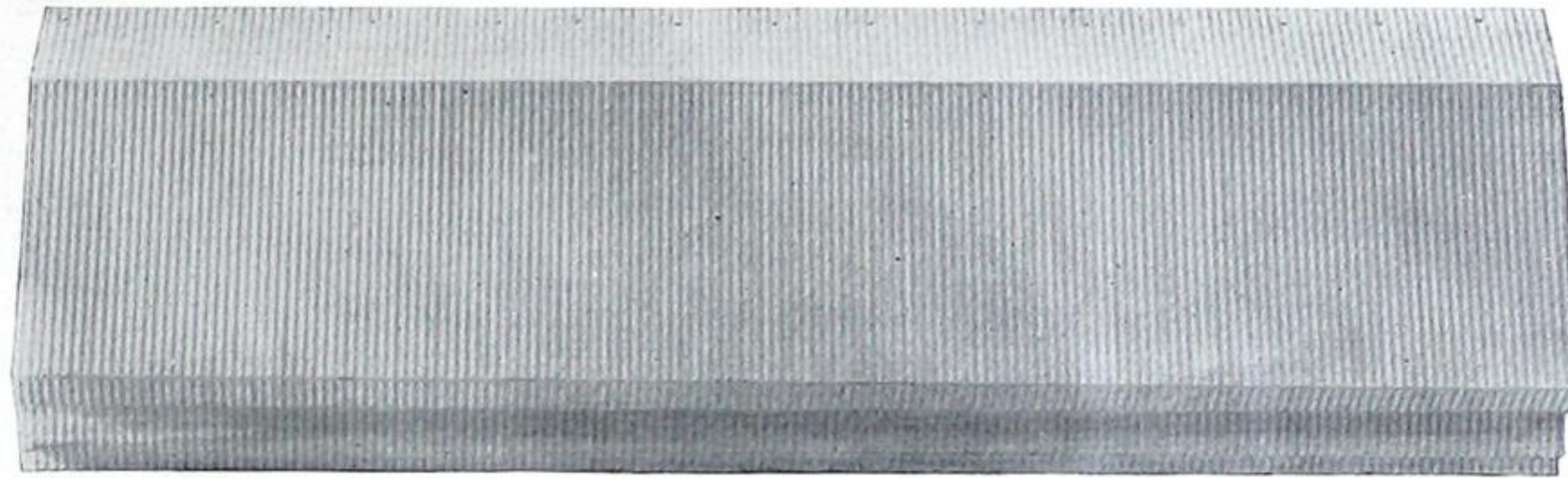

No. 1451.

Moulded Sill. Made to any detail.

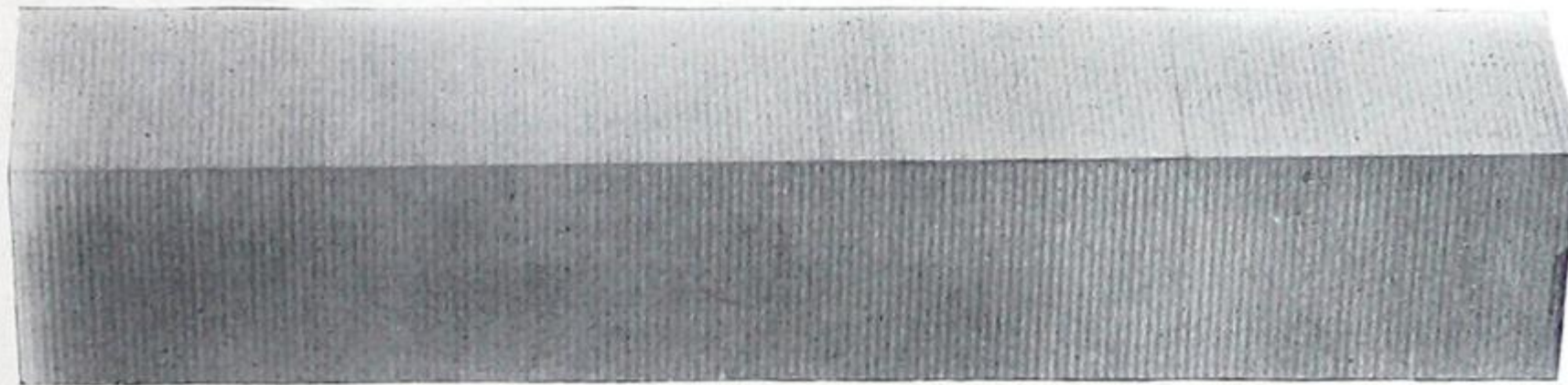

No. 1452.

Plain Sill, with throated drip. Made to any size.



Bulletin Boards.

Made from Galvanized
Steel, or Copper.



Fig. 1470.

Shows ornamental top for bulletin board, made by us from Galvanized Steel, for the "Mail and Empire," Toronto.

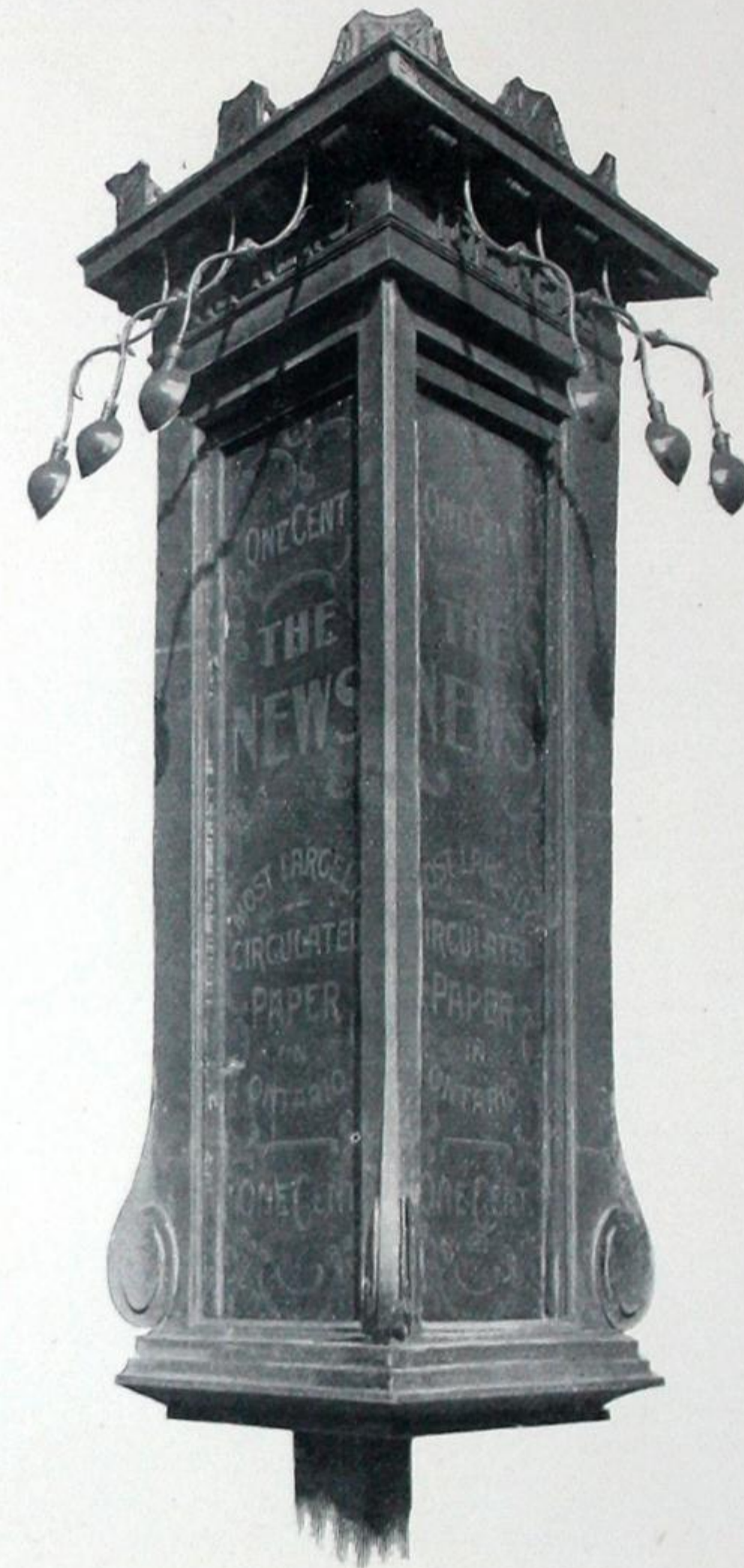

Fig. 1471.

Shows bulletin board complete, made by us from Sheet Copper for "The News," Toronto.

Our Exhibit
at the
Paris
Exhibition.

Paris, France, 1900.



Fig. 1472.

This miniature building, 8 x 10 feet, in the Roman Doric design, is entirely of sheet metal, and shows what minute detail is possible in this material.

The ceiling is deeply recessed and panelled to correspond with the general character of the design.

Finials.

Made of Copper, or Galvanized Steel.



No. 1527.
3½ feet high.



No. 1525.
3 feet high.



No. 1528.
3¾ feet high.



No. 1526.
3 feet high.



No. 1529.
4 feet high.

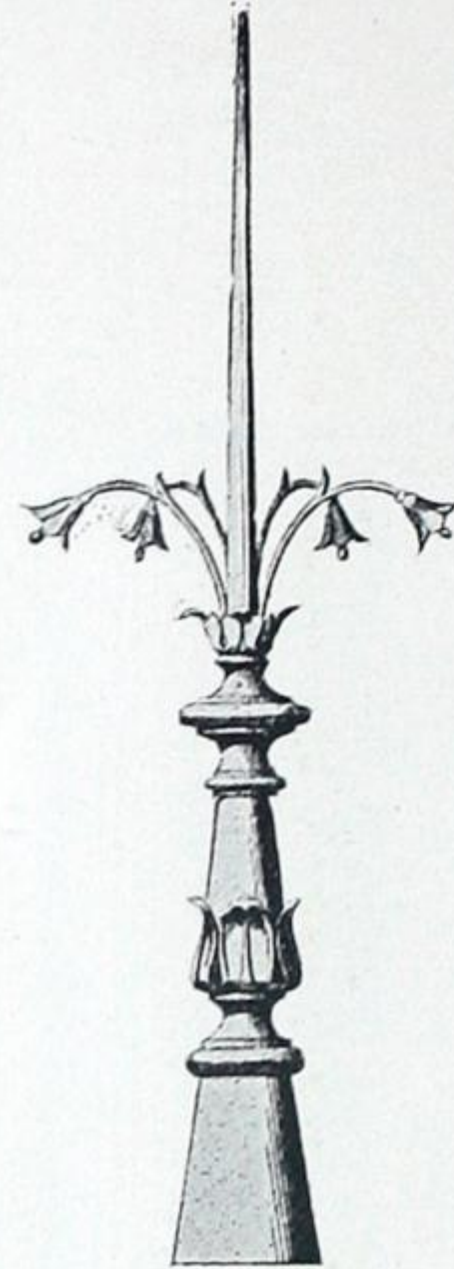

No. 1530.
4 feet high.



No. 1531.
4½ feet high.



No. 1532.
4½ feet high.

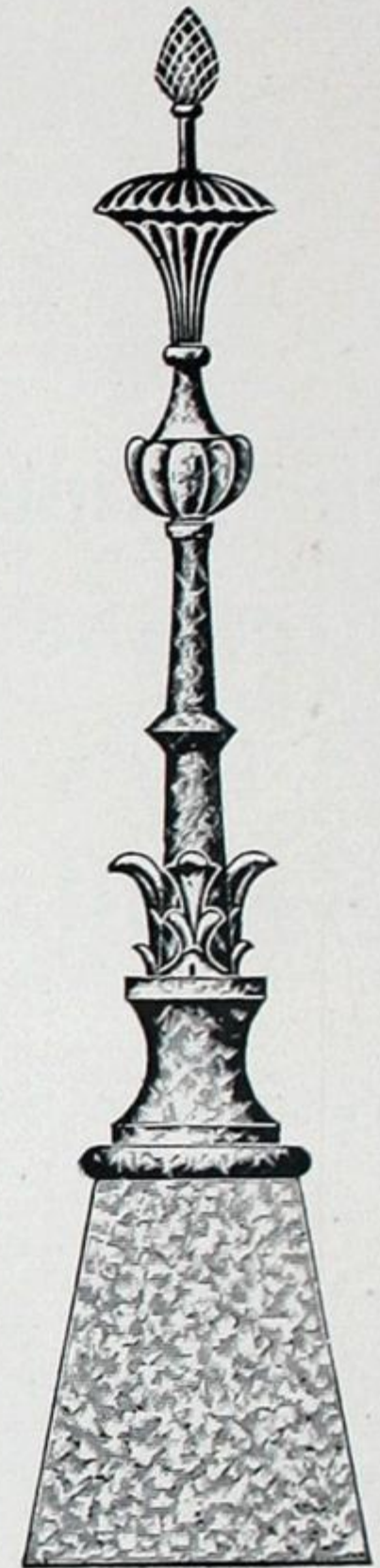

No. 1533.
5 feet high.

Base of any design shown may be made either round, square or octagonal. Order by number only, and state size and shape of base required ; also give pitch of roof.

Finials.

Made of Copper, or Galvanized Steel.



No. 1534—5 ft. high.



No. 1535—5½ ft. high.



No. 1536—5½ ft. high.



No. 1537—6 ft. high.



No. 1538—6¼ ft. high.

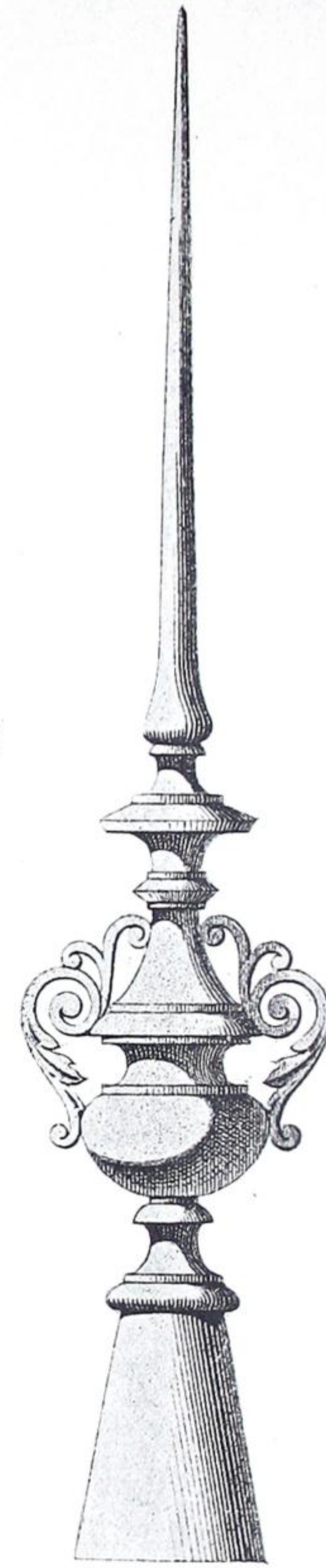

No. 1539—7 ft. high.

Base of any design shown may be made either round, square or octagonal. Order by number only, and state size and shape of base required; also give pitch of roof.

Finials.

Made of Copper, or Galvanized Steel.

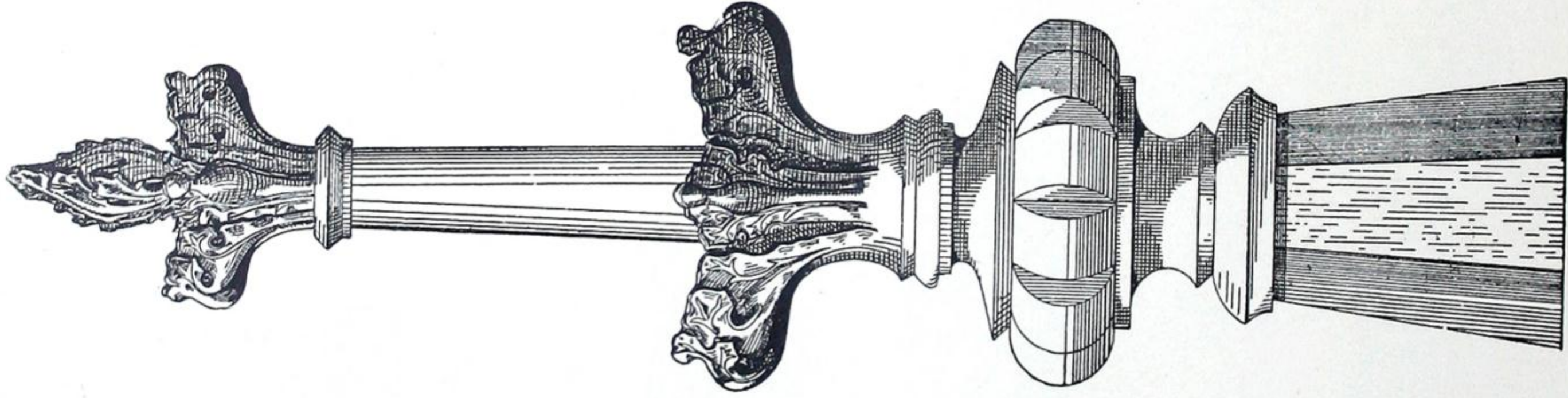

No. 1540.

7½ feet high.

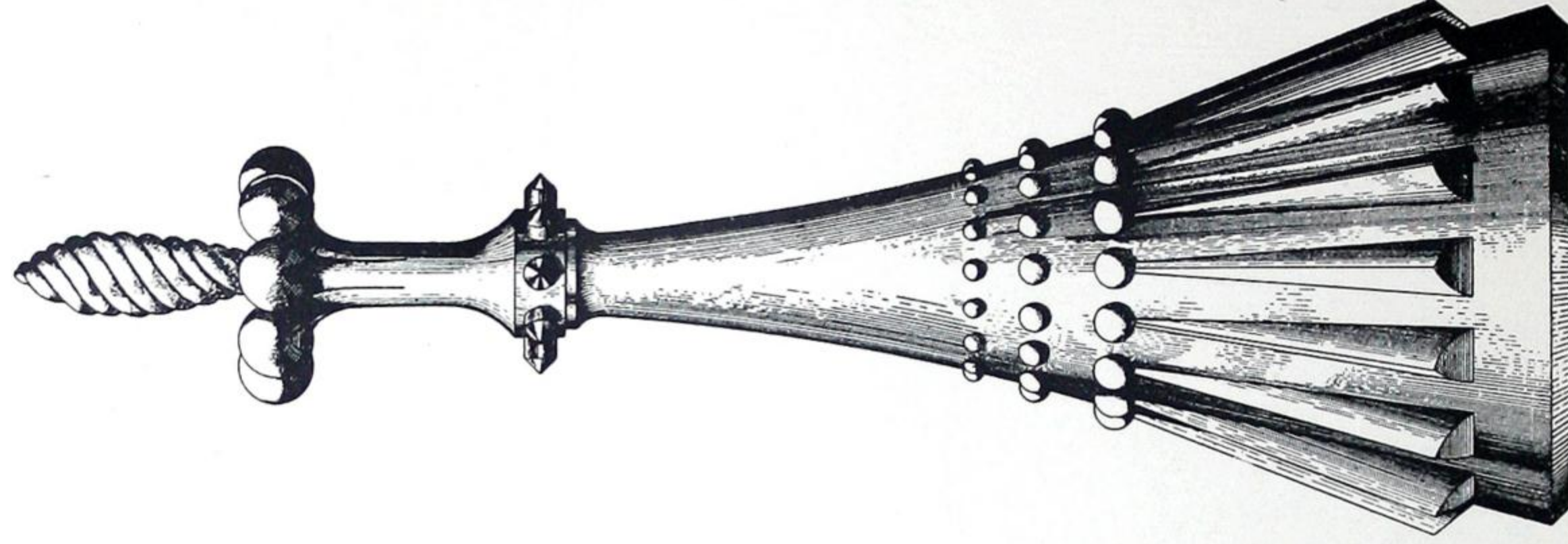

No. 1541.

6½ feet high.

Bases of most of the designs shown may be made either round, square, or octagonal. Order by number only, and state size and shape of base required; also give pitch of roof.

Finials.

Made of Copper, or Galvanized Steel.



No. 1542.
5 ft. high.

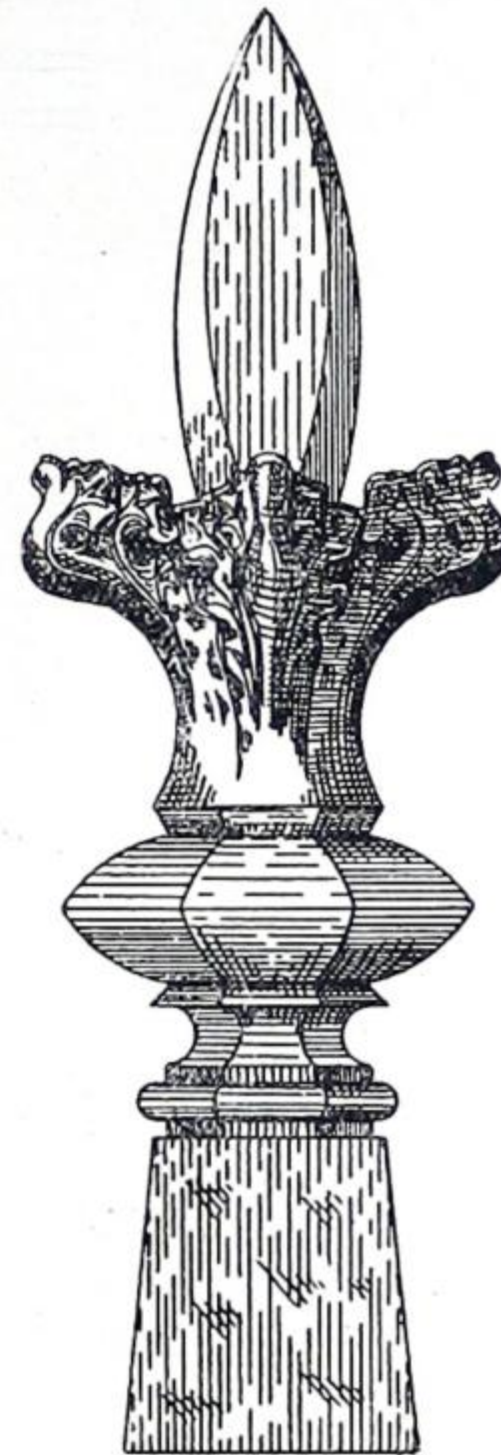

No. 1543.
4 ft. high.



No. 1544.
3½ ft. high.



No. 1545.
2 ft. 9 in. high.

Bases of most of the designs shown may be made either square, round, or octagonal. Order by number only, and state size and shape of base required; also give pitch of roof.

Finials.

Made of Copper, or Galvanized Steel.



No. 1546.
3¼ ft. high.



No. 1547.
3 ft. 2 in. high.

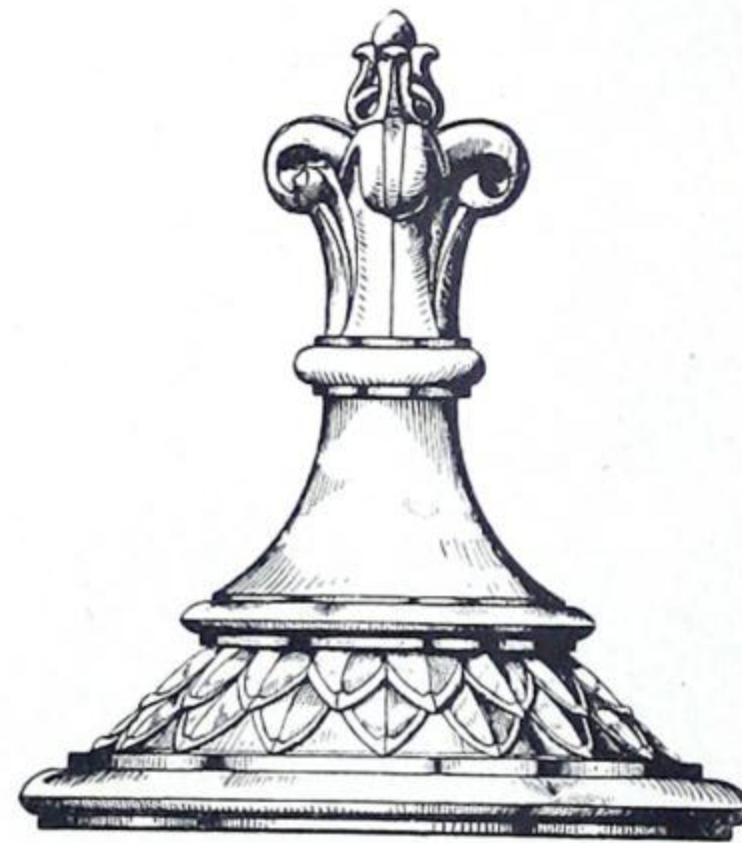

No. 1548.
2 ft. 4 in. high, 23½ in. diameter at base.



No. 1549.
2 ft. 8 in. high.



No. 1550.
2 ft. 3 in. high.

Bases of most of the designs shown may be made either square, round, or octagonal. Order by number only, and state size and shape of base required; also give pitch of roof.

Crosses.

Made of Copper, or Galvanized Steel.

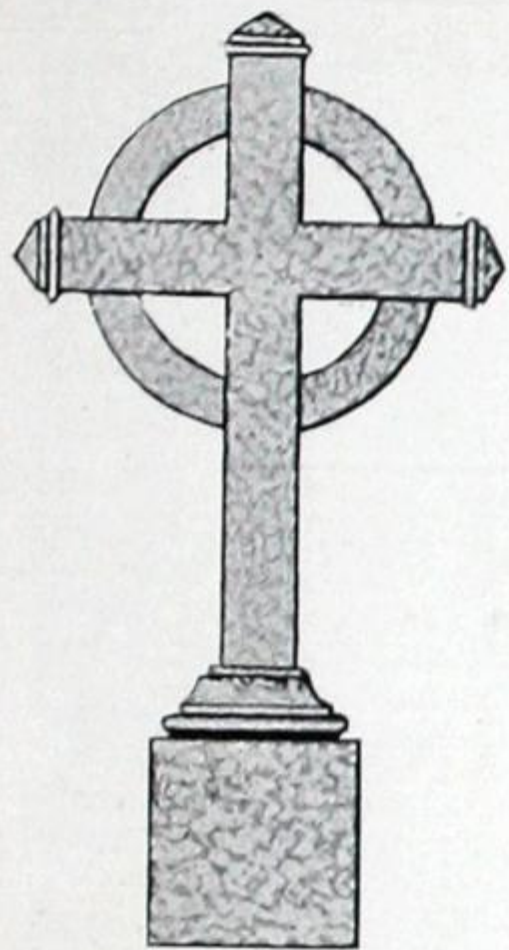

No. 1600.

5 1/3 ft. high.

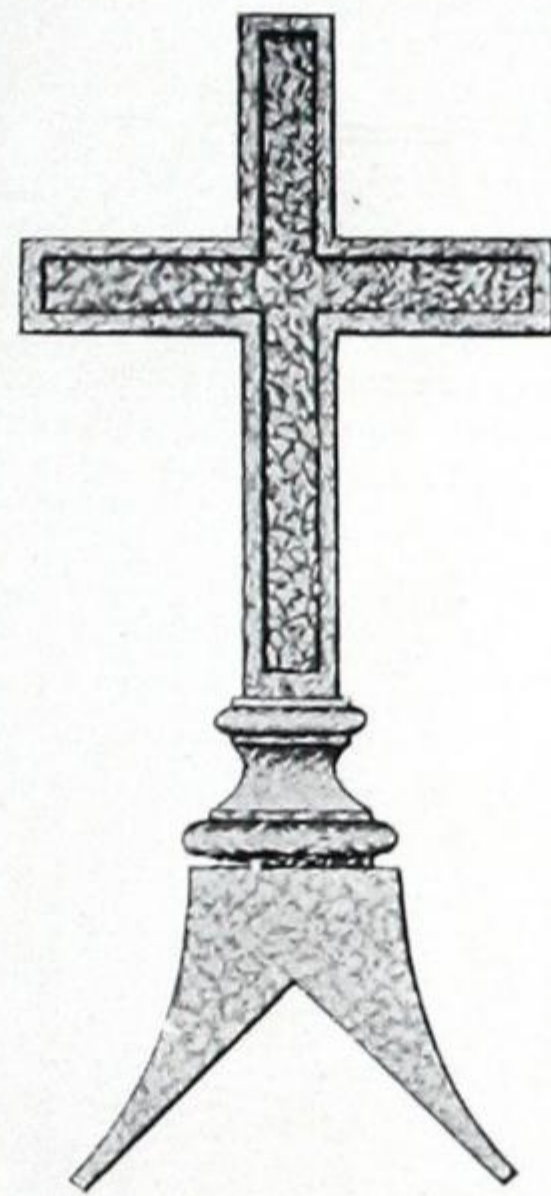

No. 1602.

6 3/4 ft. high.



No. 1601.

5 3/4 ft. high.



No. 1603.

6 3/4 ft. high.

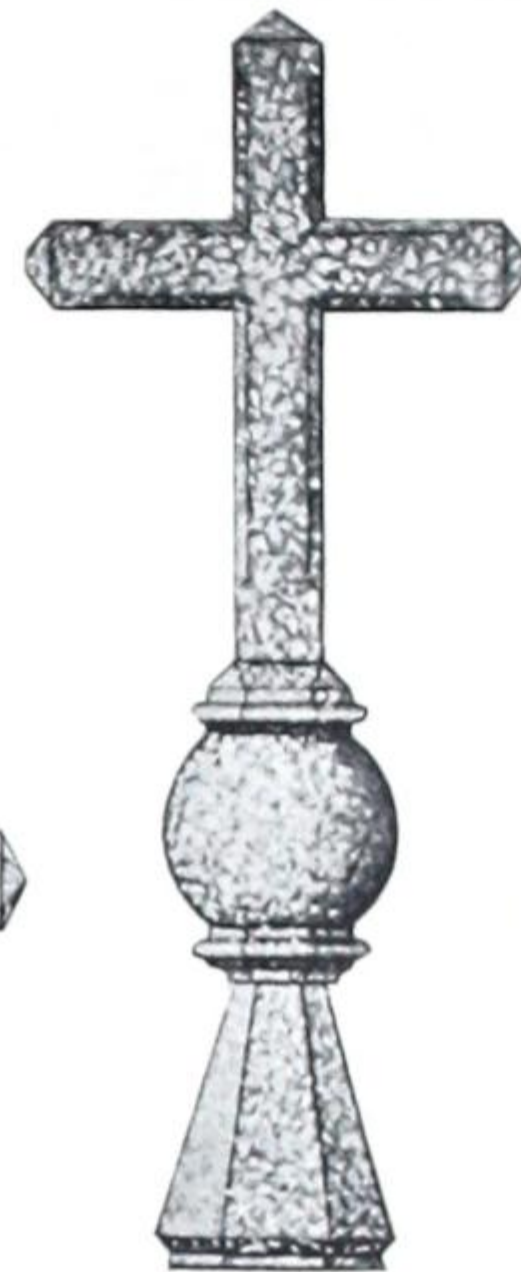

No. 1605.

7 1/2 ft. high.



No. 1604.

7 ft. high.

Base of any design shown may be made either round, square, or octagonal. Order by number, and state size and shape of base required; also give pitch of roof.

Sheet Metal Fronts.

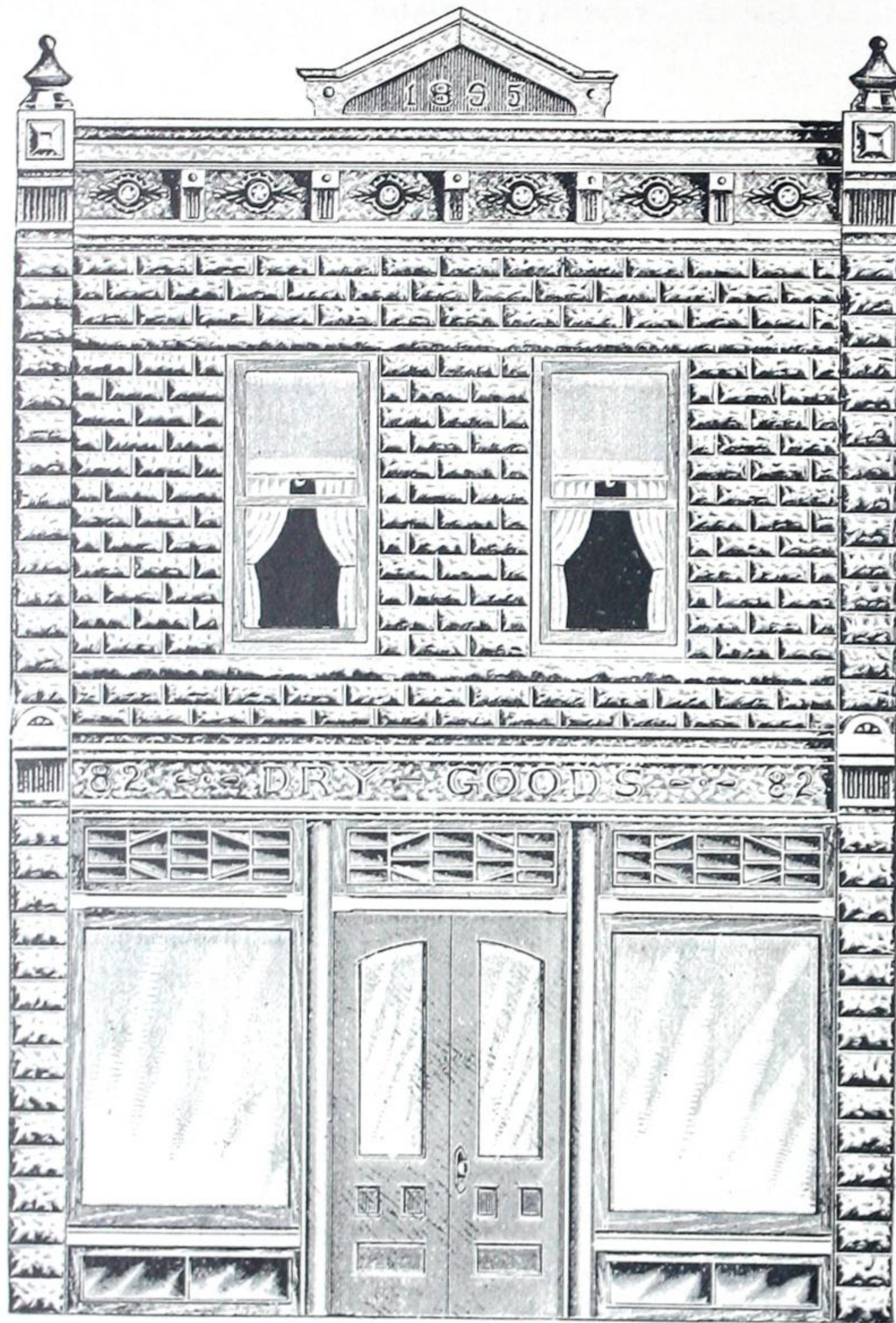

No. 2000.

Shows front, covered with rock-faced siding, with galvanized cornices.

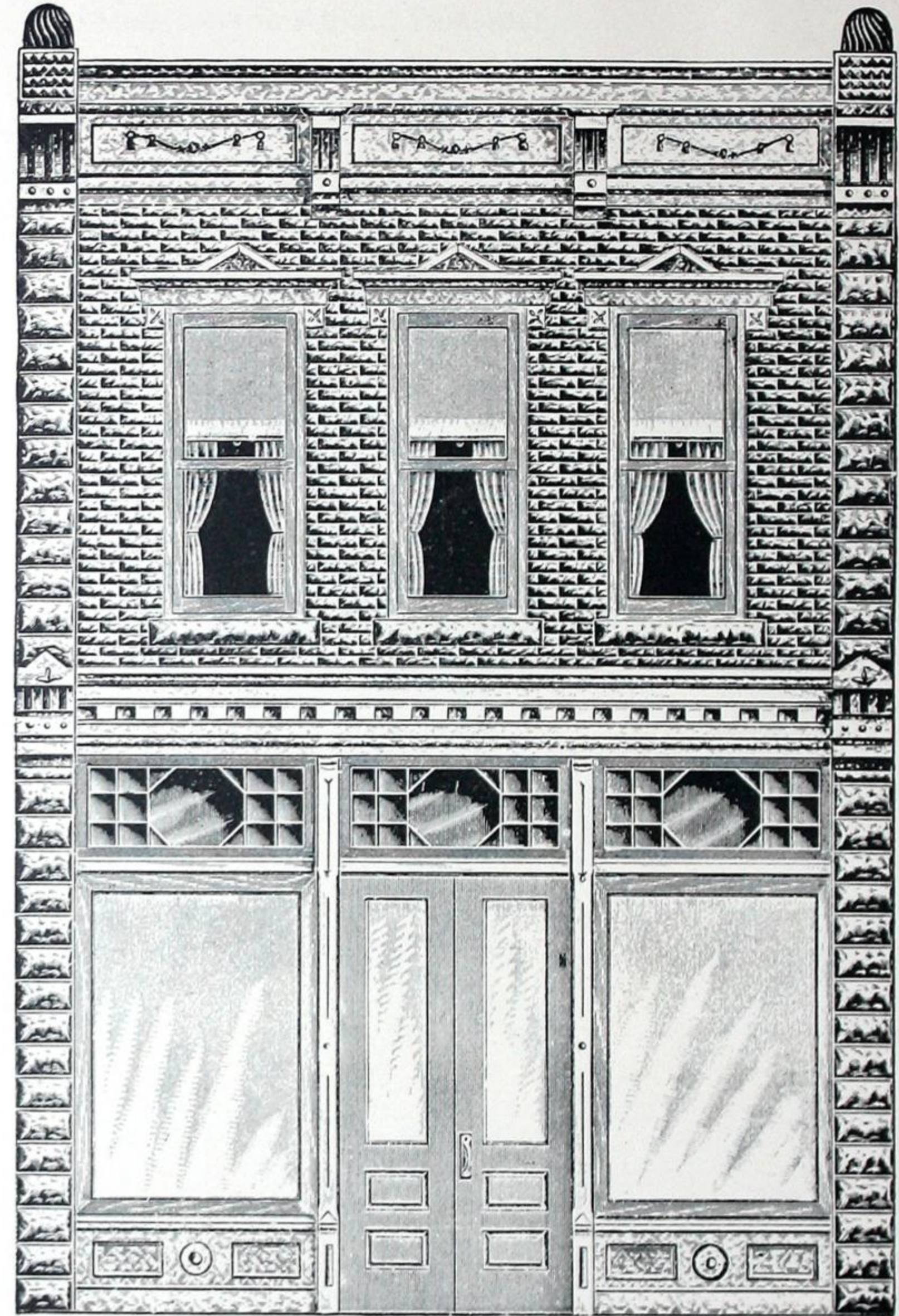

No. 2001.

Shows front, covered with our rock-faced brick siding, pilasters of rock-faced stone, with galvanized cornices.

THE METALLIC ROOFING COMPANY OF CANADA, LIMITED, TORONTO, CANADA.

Sheet Metal Front.

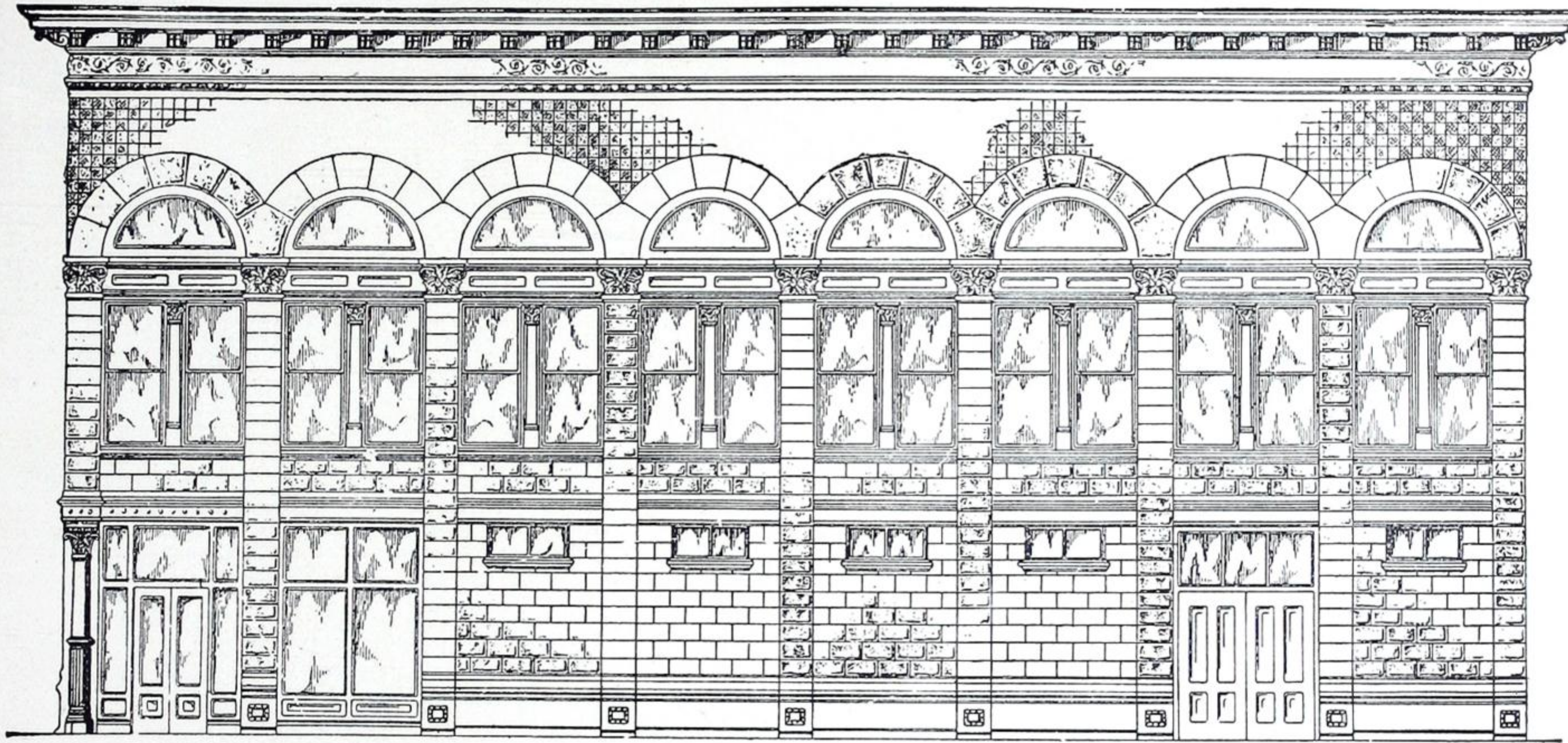

No. 2002.

Shows building covered with rock-faced stone siding, complete with pilasters, capitals, window heads and cornices.

Sheet Metal Fronts.

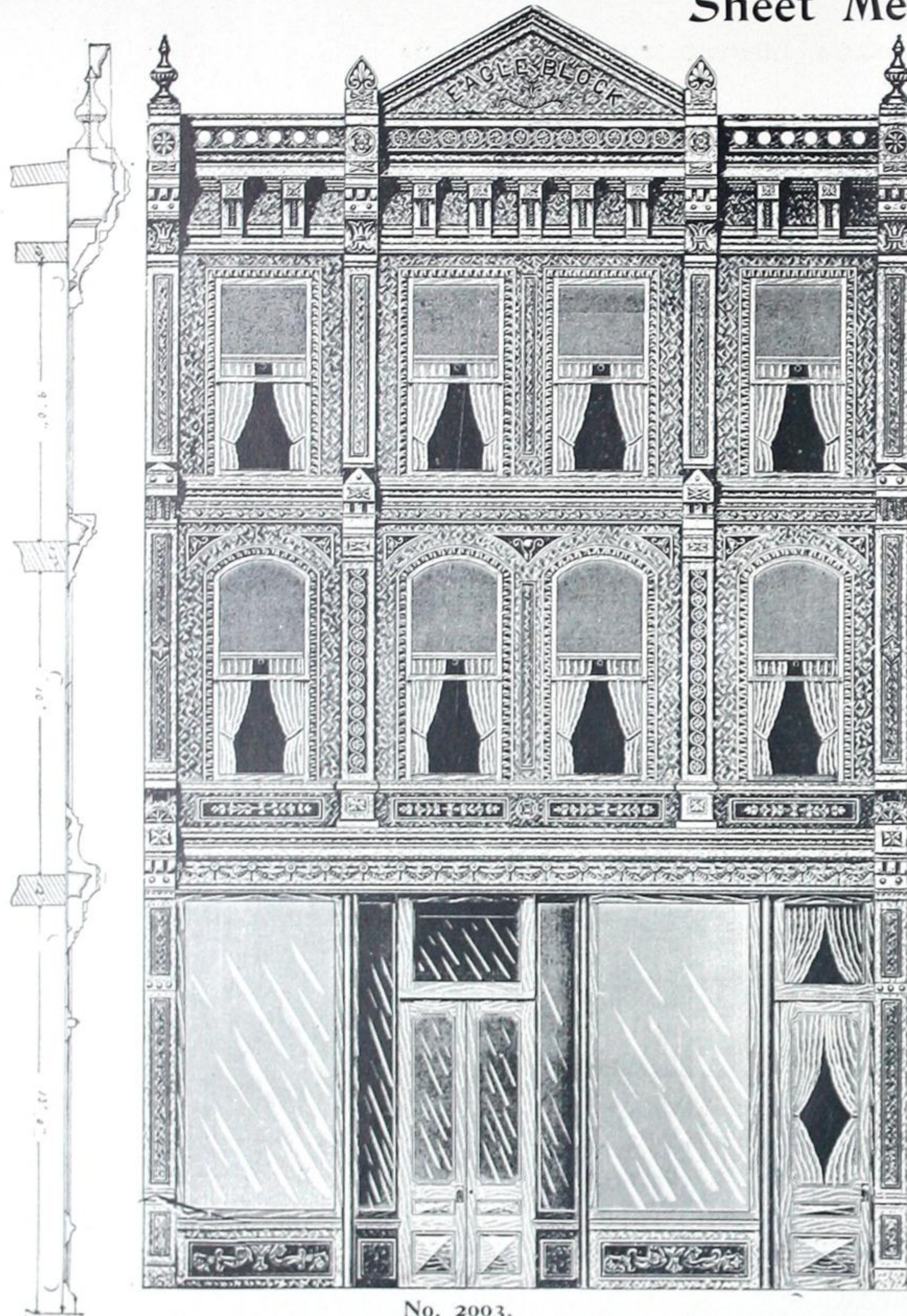

No. 2003.

Shows ornamental galvanized front, complete with cornices, pediment, pilasters, etc.

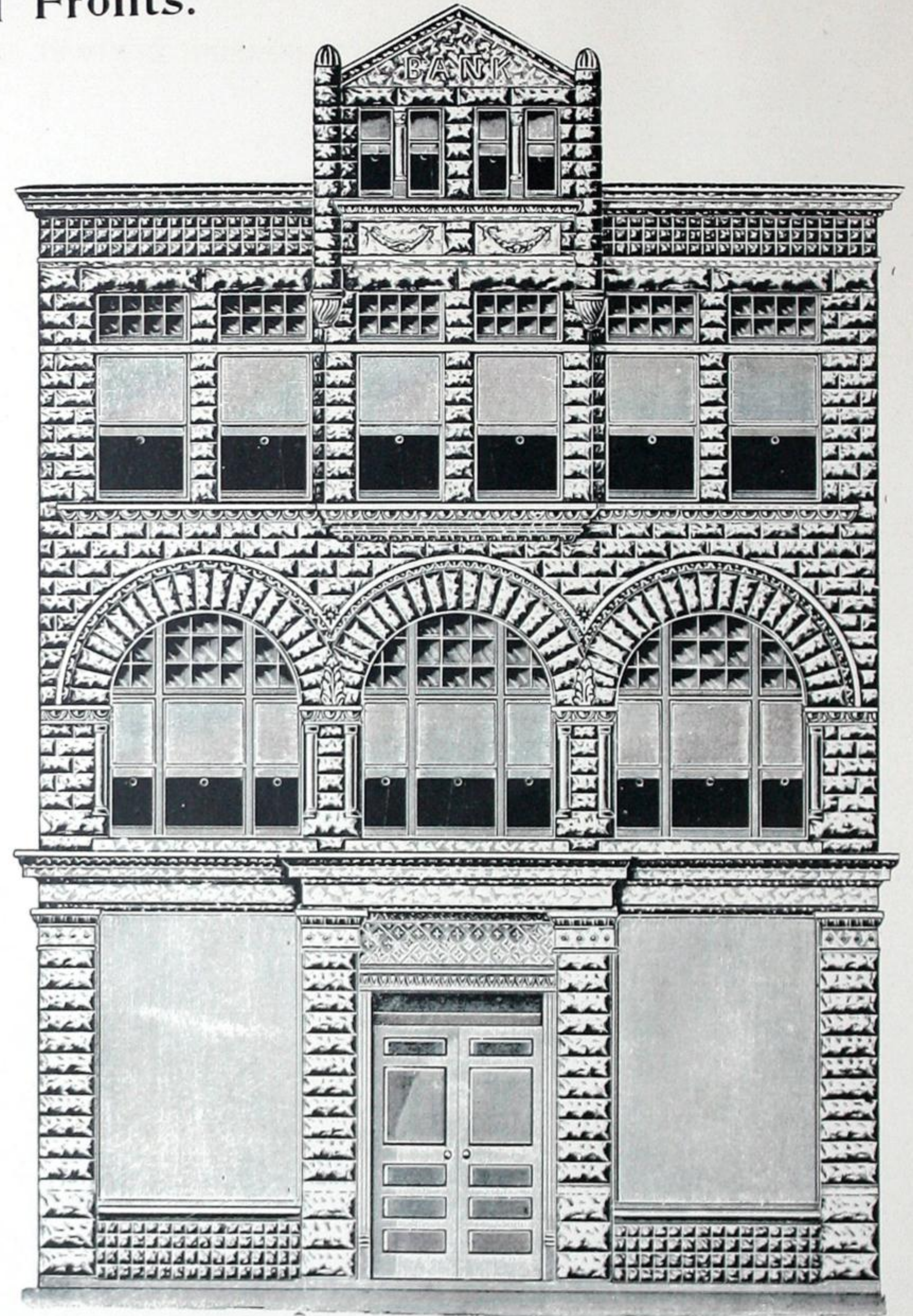

No. 2004.

Shows rock-faced front complete, including arches of same material, with ornamental label moulding and galvanized cornices.

Sheet Metal Front.

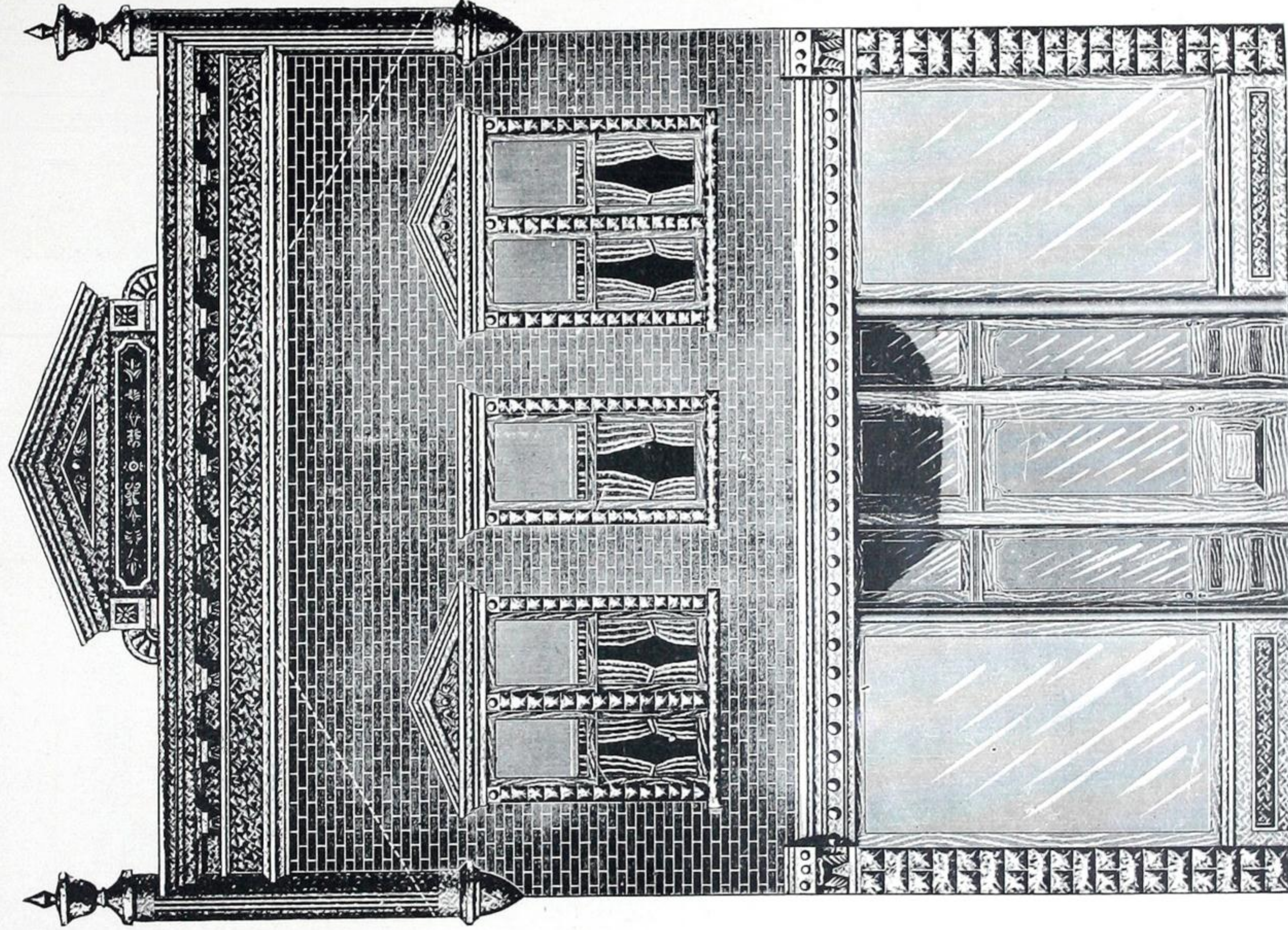

No. 2005.

Shows false front composed of sheet steel pressed brick, rock-faced piers, ornamental window caps, and galvanized cornices. Dotted lines indicate the pitch of the roof.

THE METALLIC ROOFING COMPANY OF CANADA, LIMITED, TORONTO, CANADA.

Sheet Metal Front.

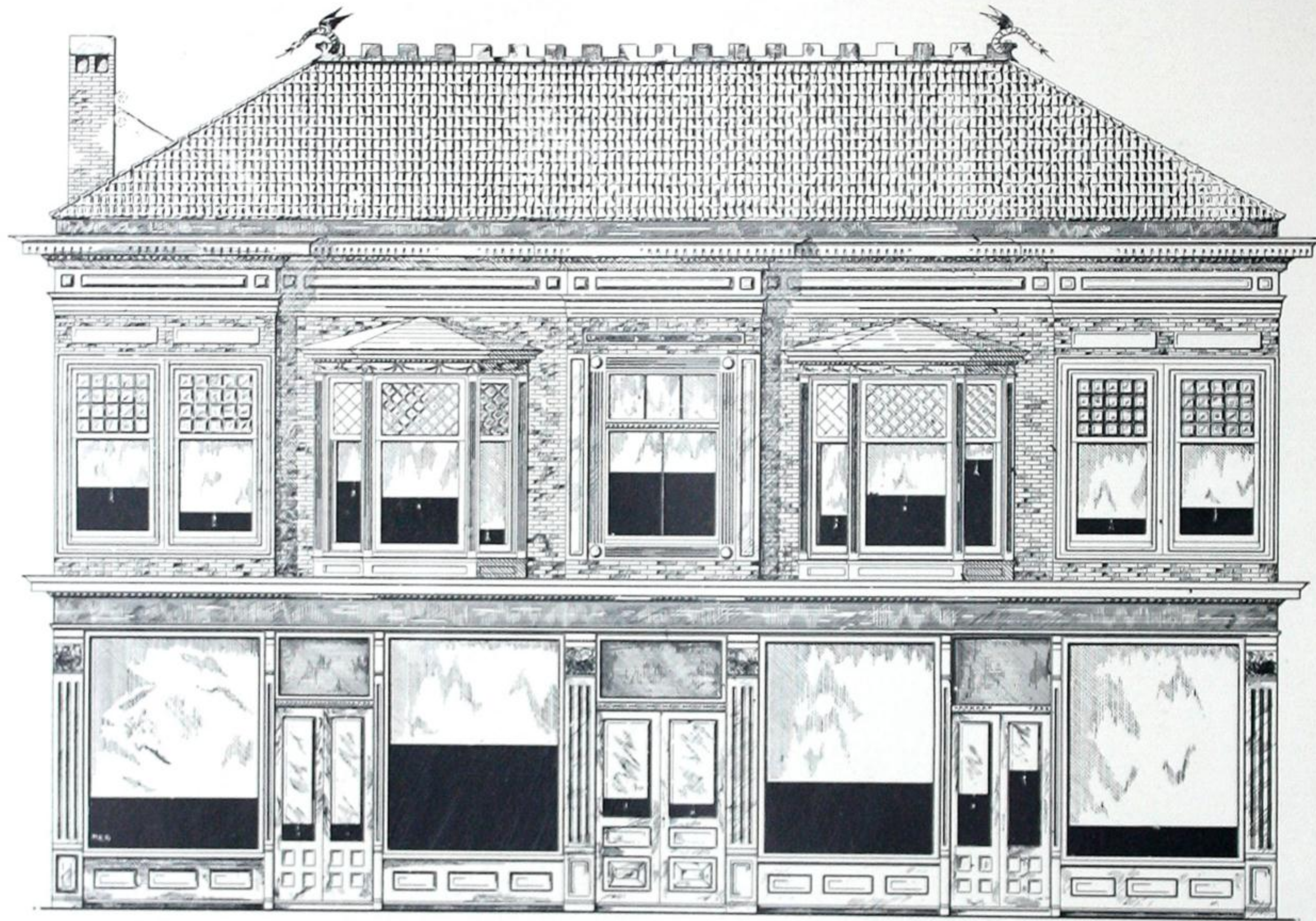

No. 2006.

Shows ornamental metal front, complete with panelling, pilasters, cornices, etc., and roof covered with metal Spanish tiles.

THE METALLIC ROOFING COMPANY OF CANADA, LIMITED, TORONTO, CANADA.

Sheet Metal Front.



No. 2007.

Shows sheet metal front, with pilasters, cornices, rock-faced stone and rock-faced brick sidings, etc., etc.

Sheet Metal Front.

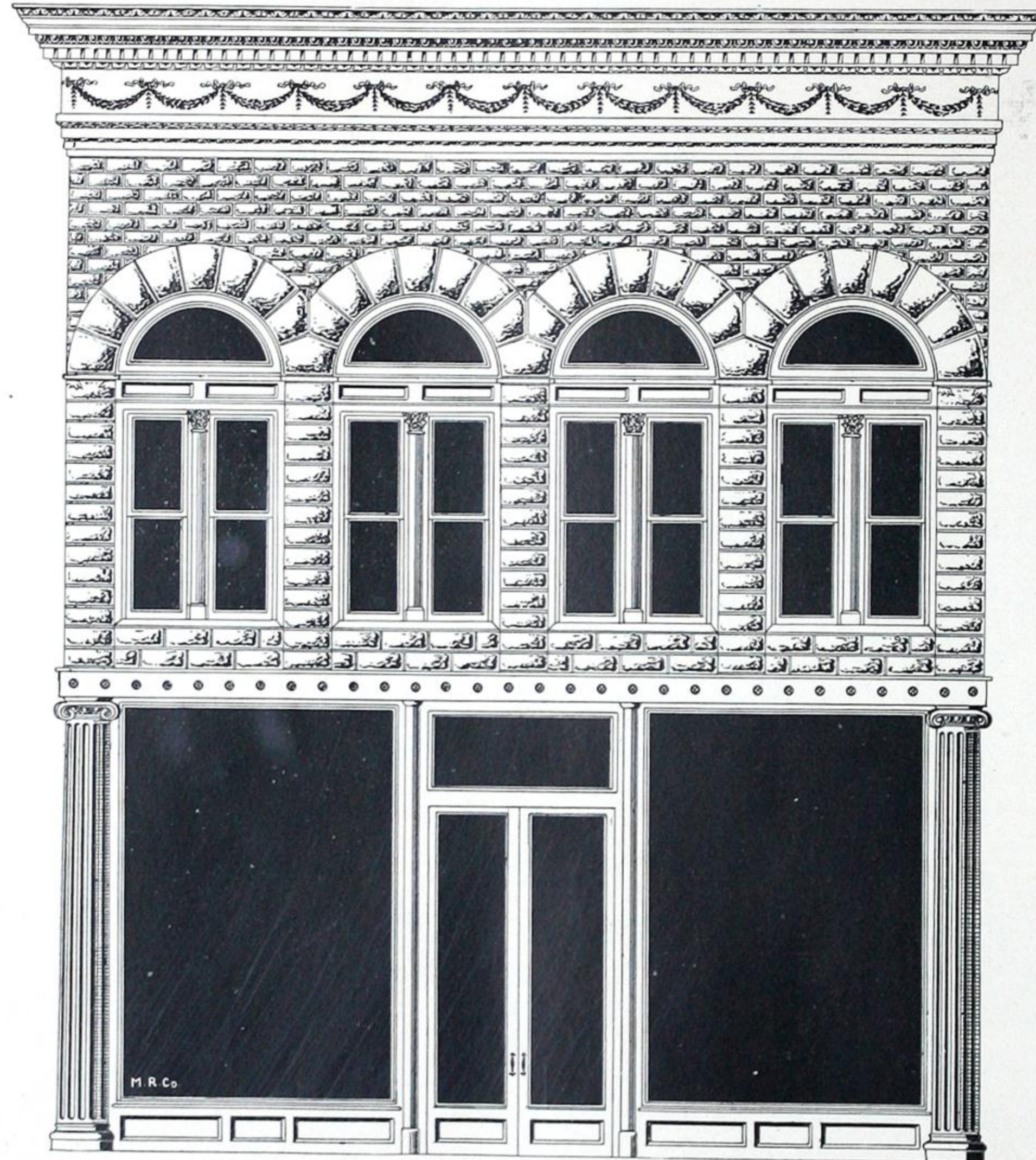

No. 2008.

Shows sheet metal front, with fluted columns, capitals, panelling, cornices, rock-faced arches, and rock-faced stone siding, etc., etc.

THE METALLIC ROOFING COMPANY OF CANADA, LIMITED, TORONTO, CANADA.

Sheet
Metal
Front.



Shows sheet metal front, with rock-
faced stone siding, cornices,
etc., etc.

No. 2009.

THE METALLIC ROOFING COMPANY OF CANADA, LIMITED, TORONTO, CANADA.

Sheet
Metal
Front.

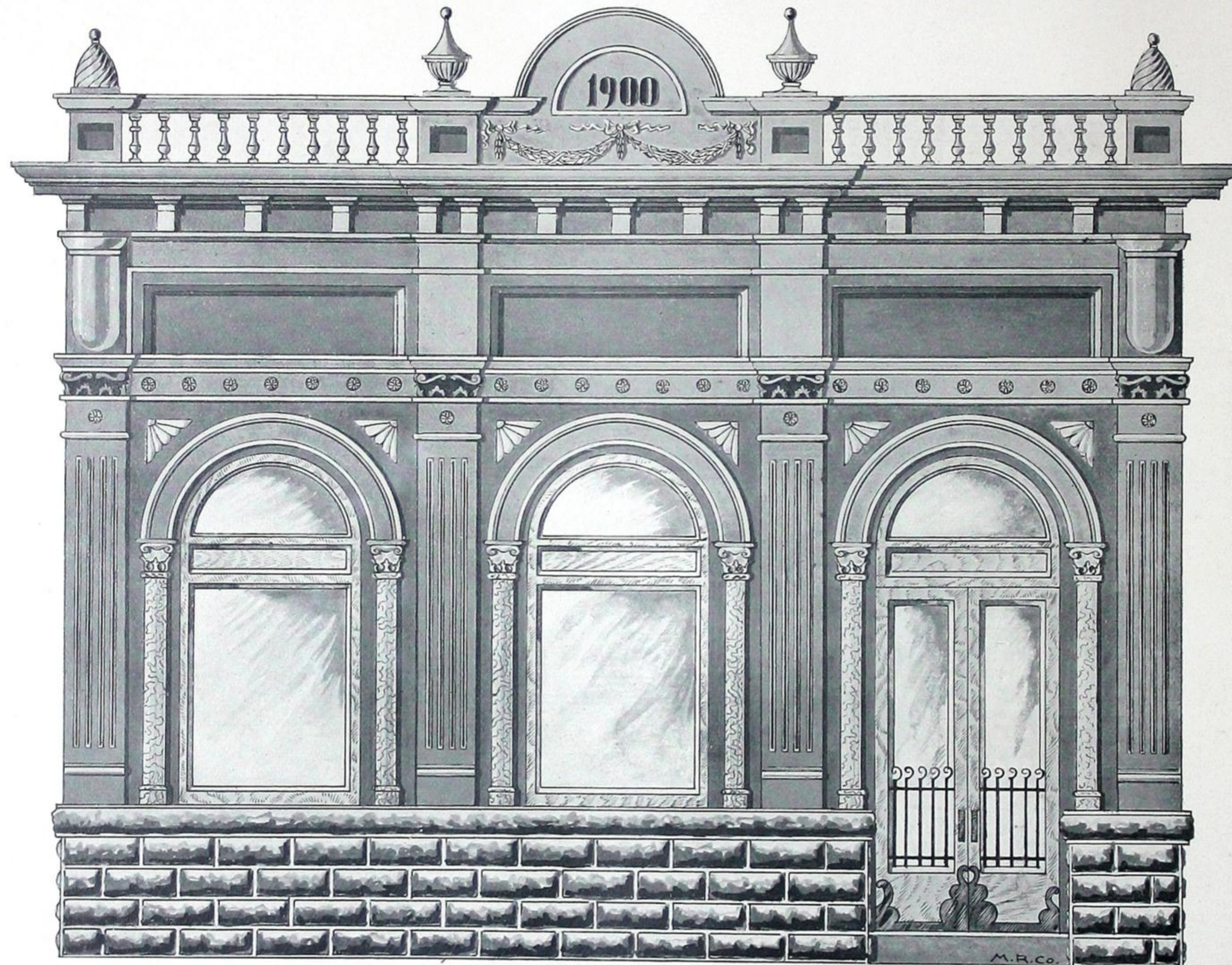

Sheet metal front, with rock-faced stone siding, fluted pilasters, round columns with bases and capitals, arched window and door heads, panelling, cornices, balustrade, pediment and urns.

No. 2010.

THE METALLIC ROOFING COMPANY OF CANADA, LIMITED, TORONTO, CANADA.

Sheet Metal Front.

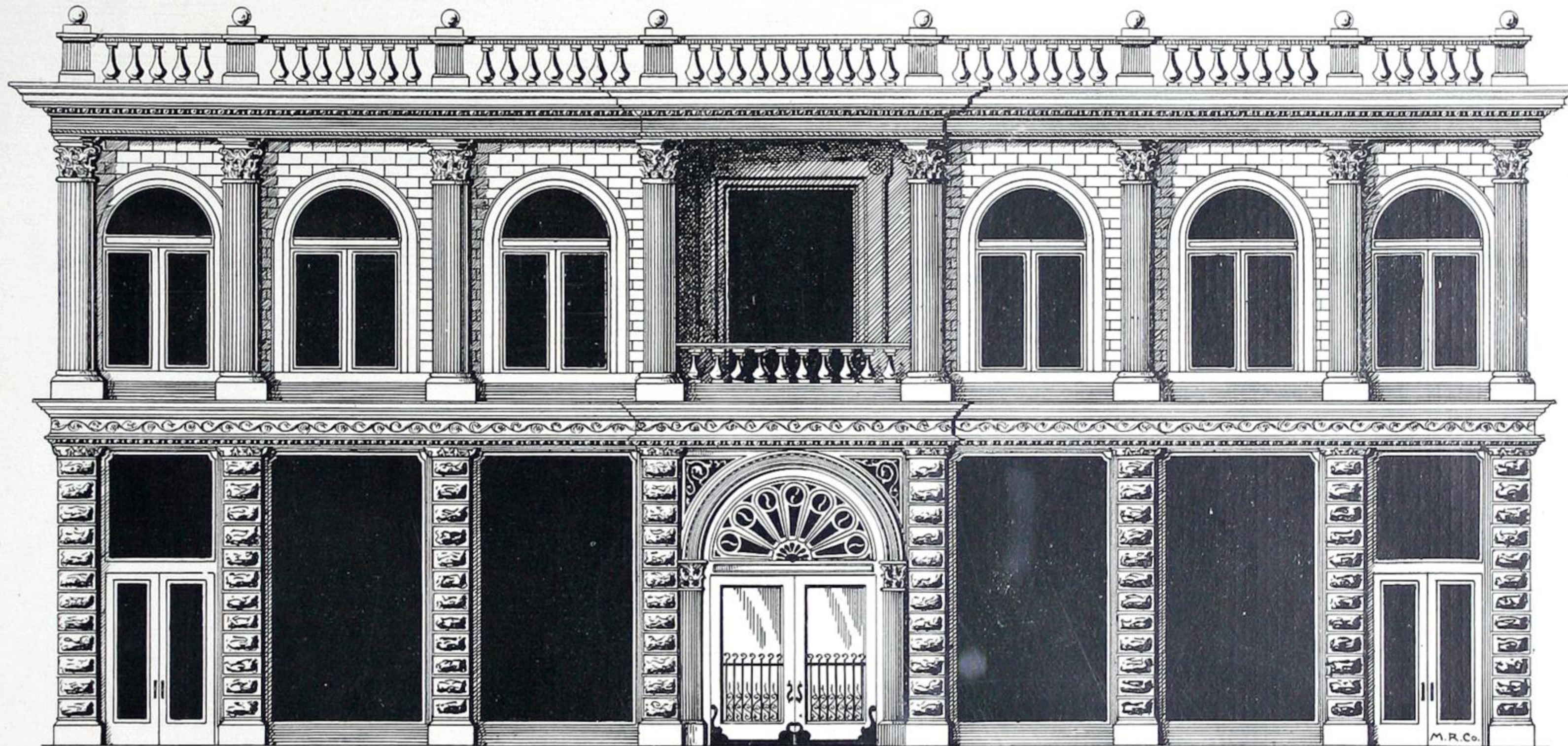

No. 2011.

Sheet metal front, with rock-faced pilasters, lintel cornice, fluted columns with bases and capitals, moulded and arched window casings, sheet steel pressed brick, main cornice, and balustrade.

Sheet Metal Front.

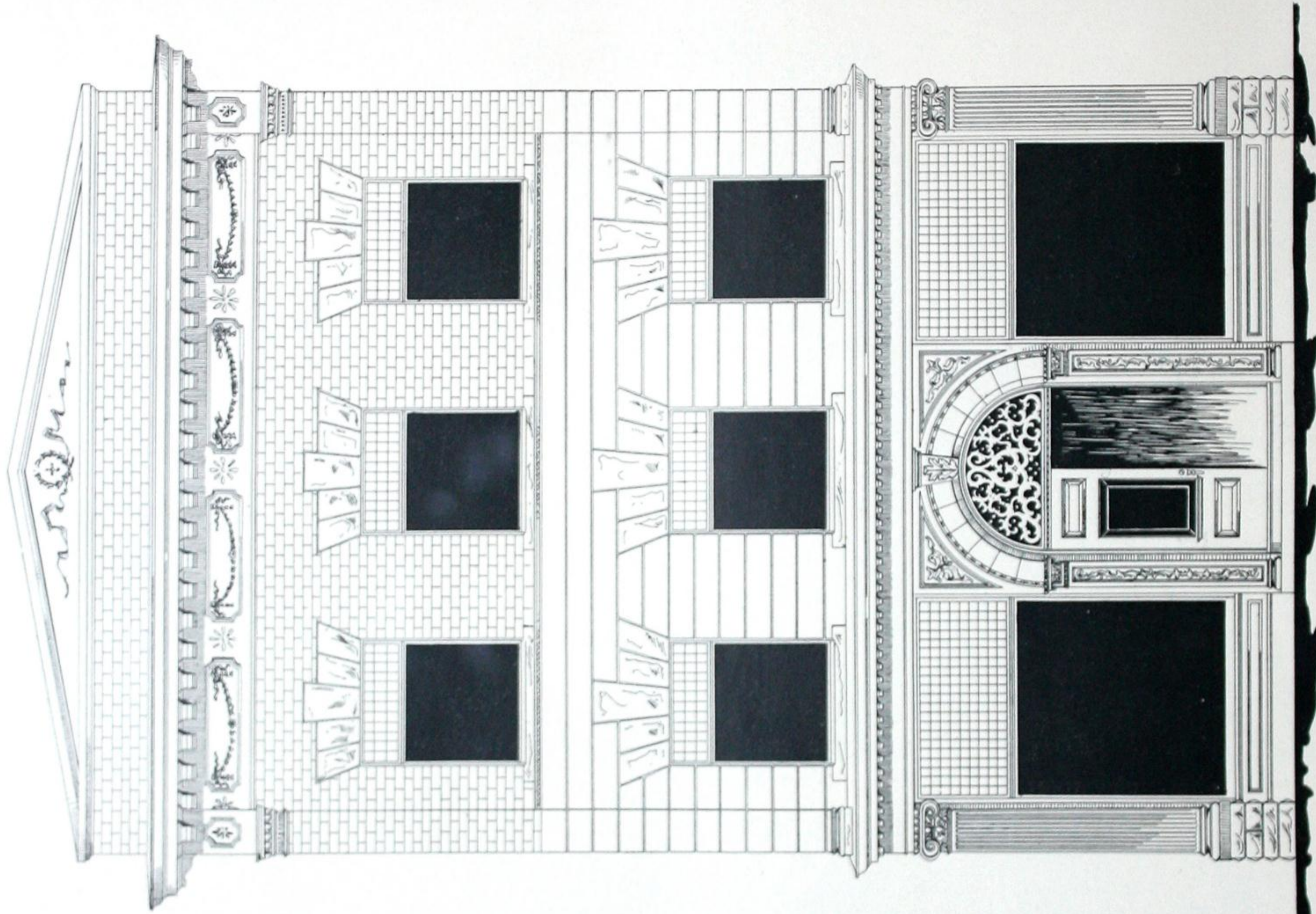

No. 2012.

Sheet metal front, with fluted pilasters complete with bases and capitals, arched door head supported by ornamental pilasters, lintel cornice, metal cut stone, rock-faced window heads and sills, string course, sheet steel pressed brick, main cornice with festoon frieze, and pediment.

THE METALLIC ROOFING COMPANY OF CANADA, LIMITED, TORONTO, CANADA.

Architectural Pressed Metal Work.



RECOGNIZING the demand for a line of strictly high-grade architectural pressed metal ornaments, enrichments, etc., we have added to our already extensive plant, a complete outfit of the newest and most up-to-date machinery for the production of this class of work. We have spared no expense in equipping our factory for manufacturing this work, so that our customers can rest assured that the reputation that we have attained for turning out only the best goods on the market in our other lines will be amply sustained in this line, and that the goods produced by us will be found to be much better than anything heretofore attempted to be made in Canada, and equal in every respect to the best and most noted foreign makers.

Our designs will be found to be architecturally correct, all details being bold and sharp in every particular. We are constantly adding new designs, so that intending purchasers who do not see illustrated in our catalogue what they want, will do well to write us, stating their requirements.

Special designs or any description of metal work can be produced by us on short notice.

Our ornaments, etc., are made from a good heavy grade of zinc, or from sheet copper.



No. 5000.
31 x 7 inches.



No. 5001.
21 x 4 inches.



No. 5002.
19 x 8 inches.

..LEAVES..



No. 5003.
14 x 6 inches.



No. 5004.
7 1/4 x 21 1/2 ins.



No. 5005.
6 1/2 x 21 inches.



No. 5006.
6 1/2 x 17 inches.



No. 5007.
9 1/2 x 20 inches.



No. 5008.
22 x 17 1/2 inches.



No. 5009.
23 x 8 3/4 inches.



No. 5010.
20 x 8 inches.



No. 5011.
18 x 6 inches.



No. 5012.
18 x 3 inches.



No. 5013.
10 x 4 1/2 inches.



No. 5014.
8 x 4 inches.

Leaves, Volutes and Crockets.



No. 5015.
16 x 7 $\frac{3}{4}$ inches.



No. 5016.
14 x 7 inches.



No. 5017.
12 x 4 $\frac{3}{4}$ inches.



No. 5018.
12 x 3 $\frac{1}{4}$ inches.



No. 5019.
11 x 5 $\frac{3}{4}$ inches.



No. 5020.
10 $\frac{1}{2}$ x 7 $\frac{3}{4}$ inches.



No. 5021.
10 x 5 $\frac{3}{4}$ inches.



No. 5022.
9 $\frac{1}{2}$ x 6 inches.



No. 5023.
7 x 5 $\frac{3}{4}$ inches.



No. 5024.
13 $\frac{1}{2}$ x 8 $\frac{3}{4}$ inches.



No. 5025.
5 x 3 $\frac{1}{4}$ inches.



No. 5026.
12 $\frac{1}{2}$ x 8 inches.



No. 5027.
12 x 9 inches.



No. 5028.
11 $\frac{1}{2}$ x 8 inches.



No. 5029.
11 x 9 inches.



No. 5030.
13 $\frac{1}{4}$ x 7 inches.



No. 5200.
13 x 18 inches.



No. 5201.
8 $\frac{1}{2}$ x 11 inches.



No. 5202.
5 $\frac{1}{2}$ x 7 $\frac{1}{2}$ inches.



No. 5203.
6 $\frac{3}{4}$ x 14 inches.



No. 5204.
7 x 12 inches.



No. 5205.
4 \times 4 x 13 $\frac{1}{2}$ inches.

We are constantly adding new designs. If you do not find illustrated what you want, write us.

Scrolls.



LEFT. No. 5300. RIGHT.
26½ inches each.

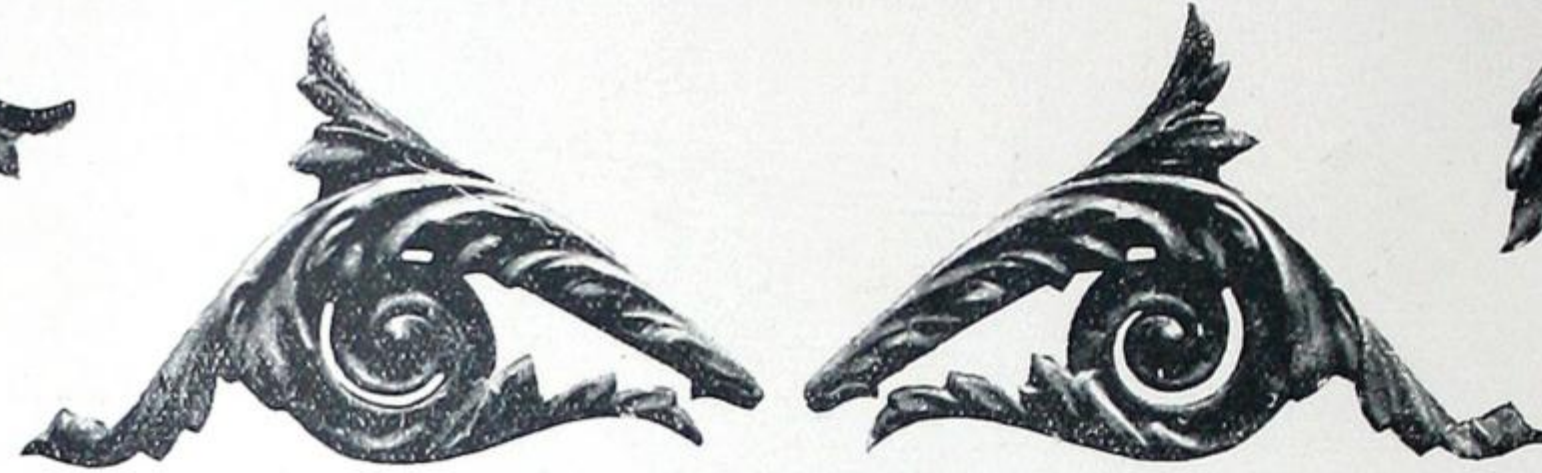

LEFT. No. 5301. RIGHT.
16 x 20 inches each.



LEFT. No. 5302. RIGHT.
9 x 9 inches each.



LEFT. No. 5303. RIGHT.
24 inches each.



LEFT. No. 5304. RIGHT.
12 x 26 inches each.



LEFT. No. 5305. RIGHT.
11 x 15½ inches each.

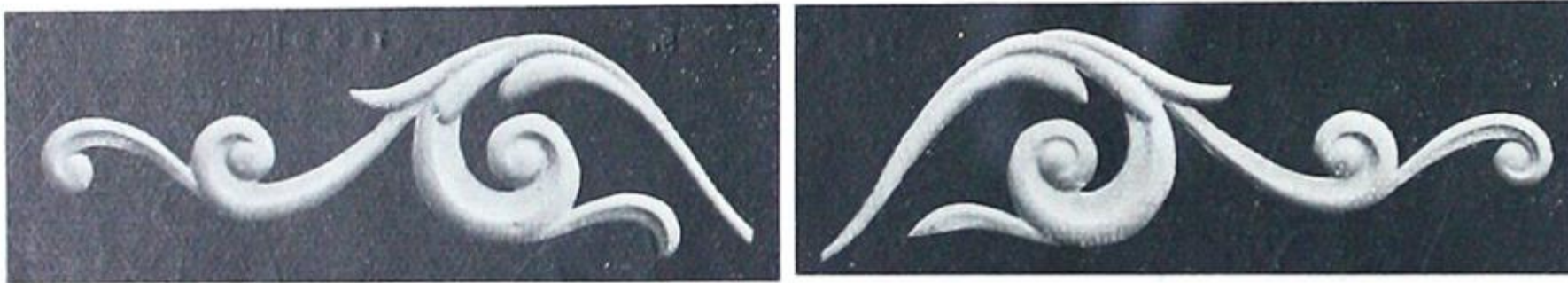

LEFT. No. 5306. RIGHT.
19 x 5½ inches each.



LEFT. No. 5307. RIGHT.
14½ x 5 inches each.



LEFT. No. 5308. RIGHT.
26 x 12 inches each.

NEW DESIGNS and Sizes are being constantly added. Let us know your requirements.

Scrolls and Spandrel Ornaments.

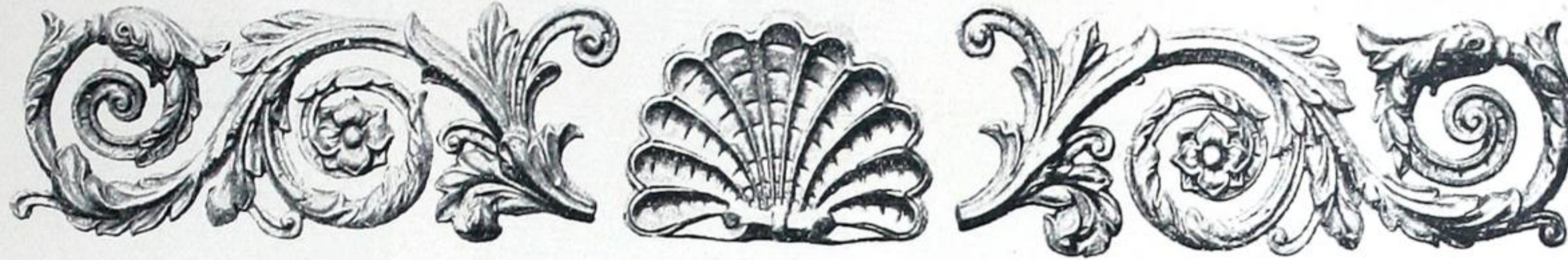

No. 5309.
13 x 86 inches.



LEFT. No. 5310. RIGHT.
10 x 11 inches each.



LEFT. No. 5311. RIGHT.
8½ x 19 inches each.



No. 5312.
12 x 43 inches.

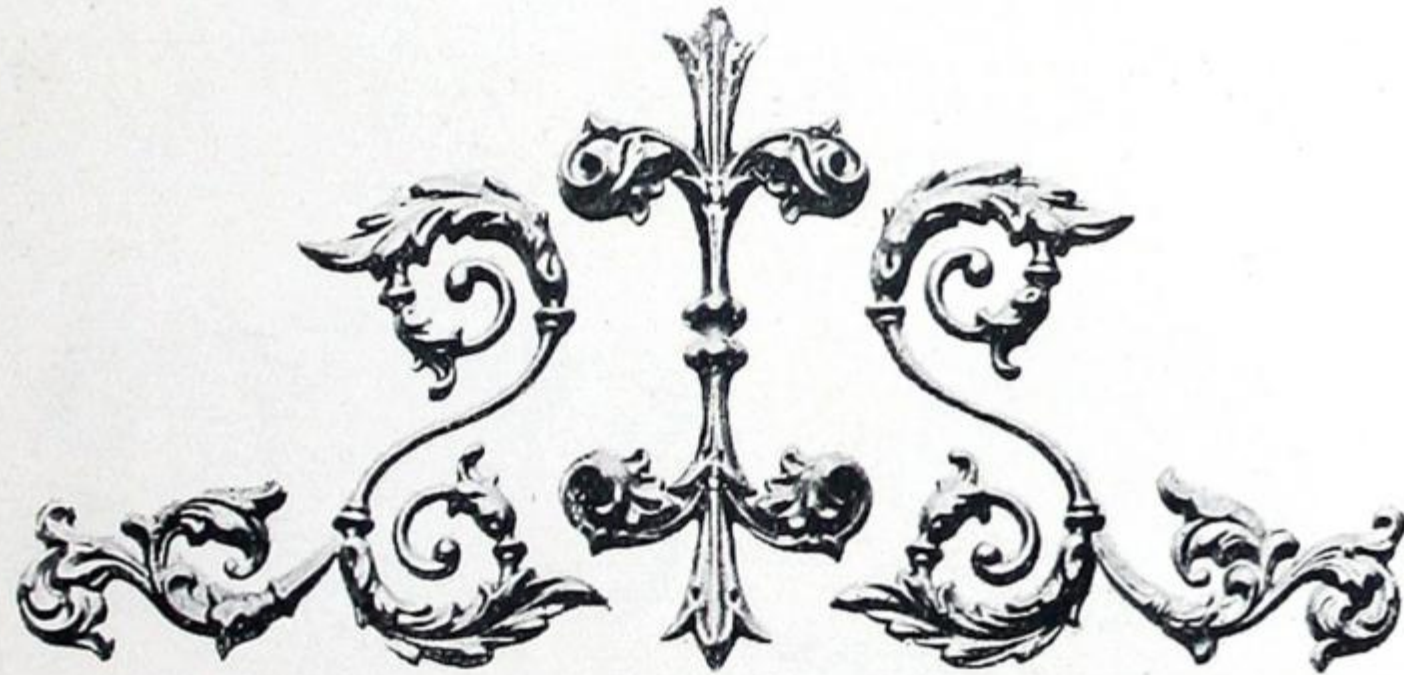

No. 5313.
24 x 51 inches.



No. 5314.
20 x 36 inches.



No. 5315.
12 x 29 inches.

New designs are being constantly added. If you do not find illustrated what you require, write us.

Fleur-de-lis, Shells and Ornaments.



No. 5500.
11 1/2 x 9 1/2 inches.



No. 5502.
5 x 4 inches.



No. 5504.
9 x 5 inches.

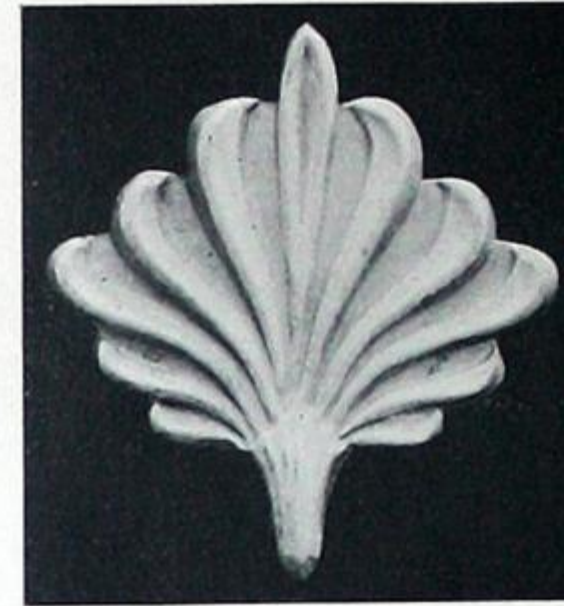

No. 5503.
7 x 8 inches.

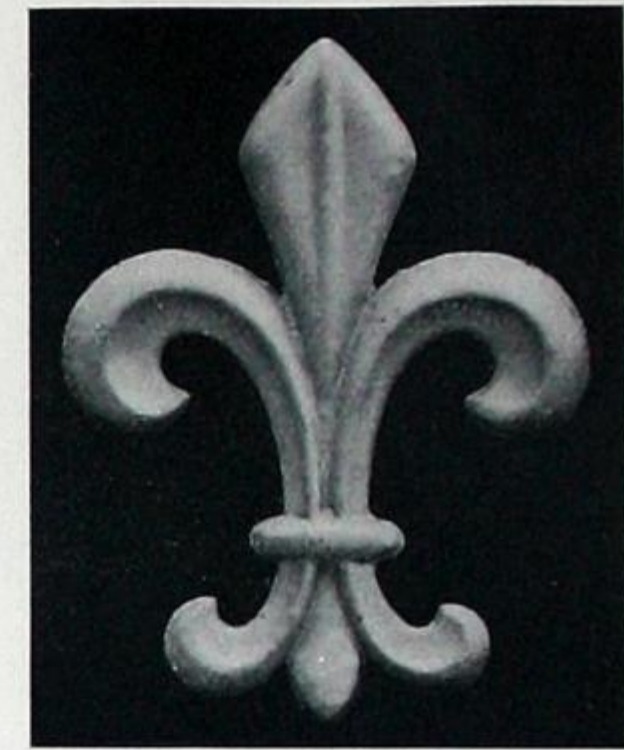

No. 5501.
7 x 5 inches.



No. 5505.
4 x 4 1/2 inches.



No. 5506.
11 1/2 x 19 1/4 inches.



No. 5507.
13 x 13 1/2 inches.



No. 5508.
9 x 10 1/2 inches.



No. 5509.
7 x 16 inches.



No. 5510.
7 1/2 x 18 inches.



LEFT.
4 x 8 inches.



No. 5511.
RIGHT.
4 x 8 inches.



No. 5512.
5 x 9 inches.



No. 5513.
12 1/2 x 17 inches.

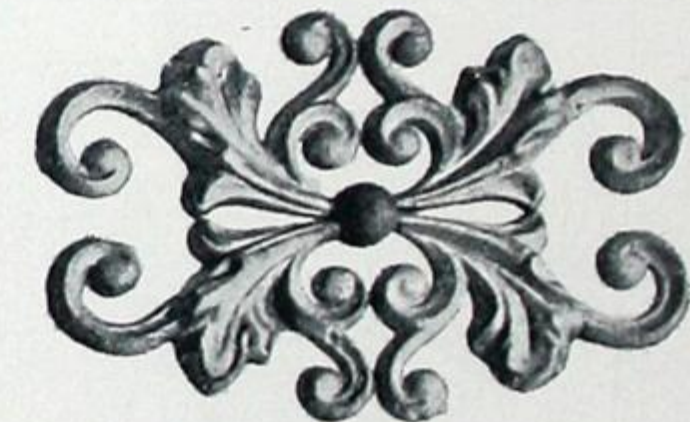

No. 5514.
15 1/2 x 24 inches.

New designs are being constantly added. If you do not find illustrated what you want, write us.

Tympanum Panels.

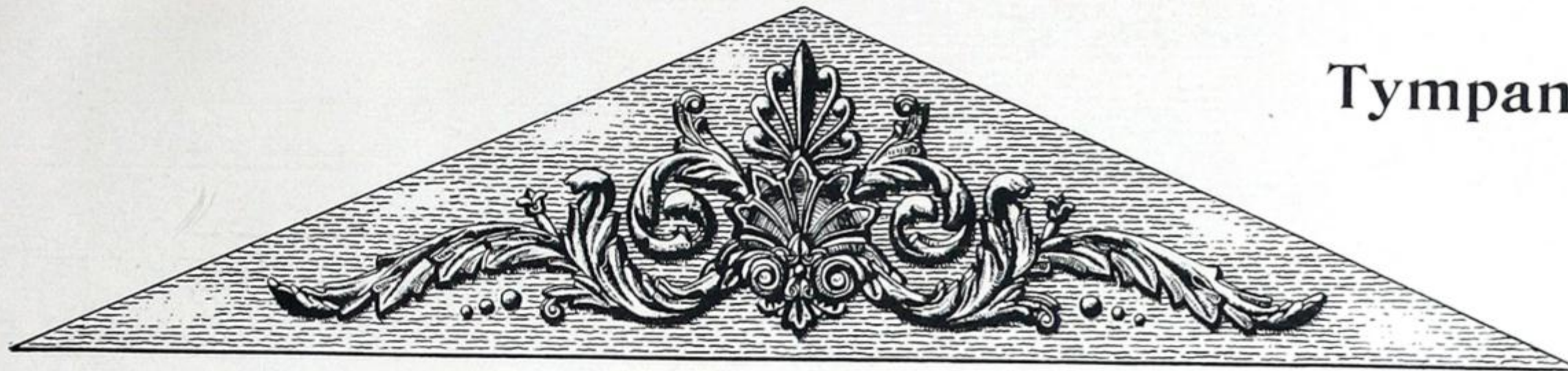

No. 5800.—25 x 111 inches.

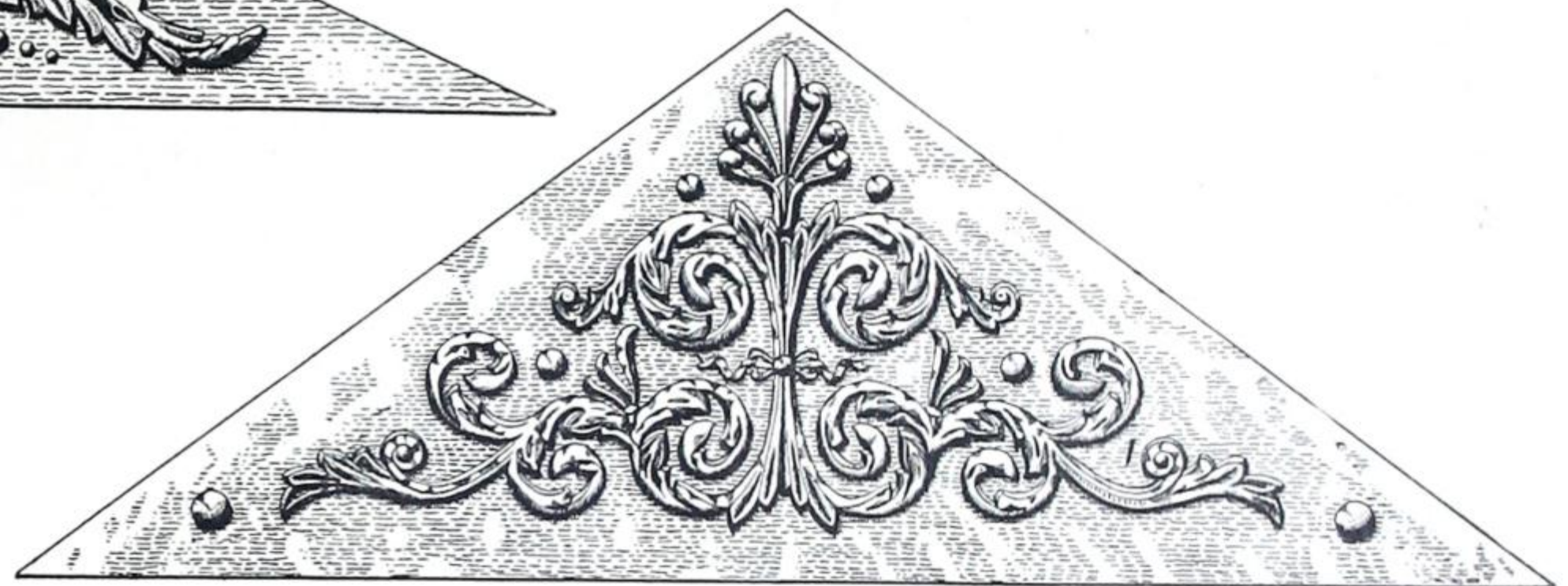

No. 5801.—36 x 96 inches.

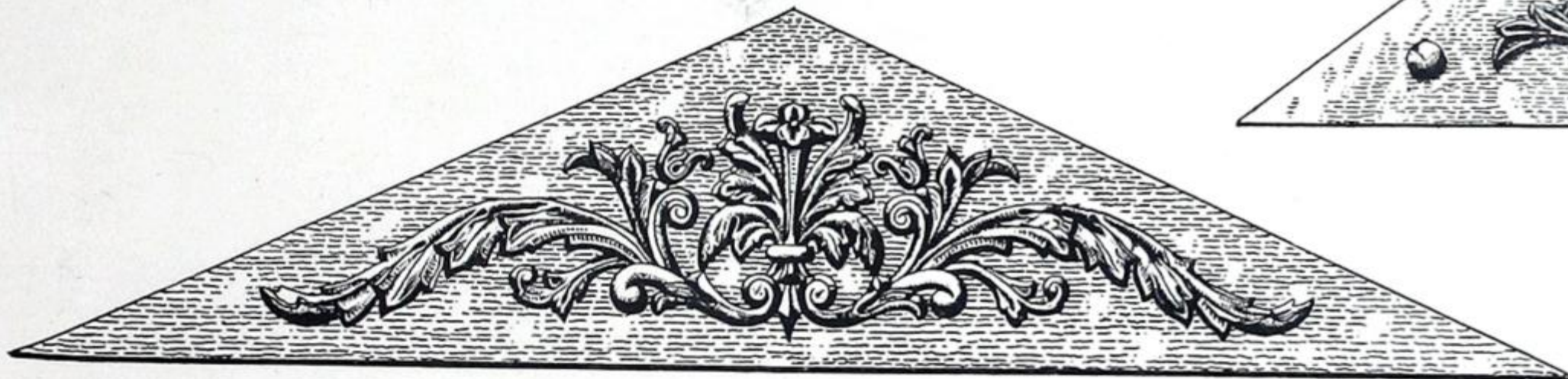

No. 5802.—23 x 99 inches.

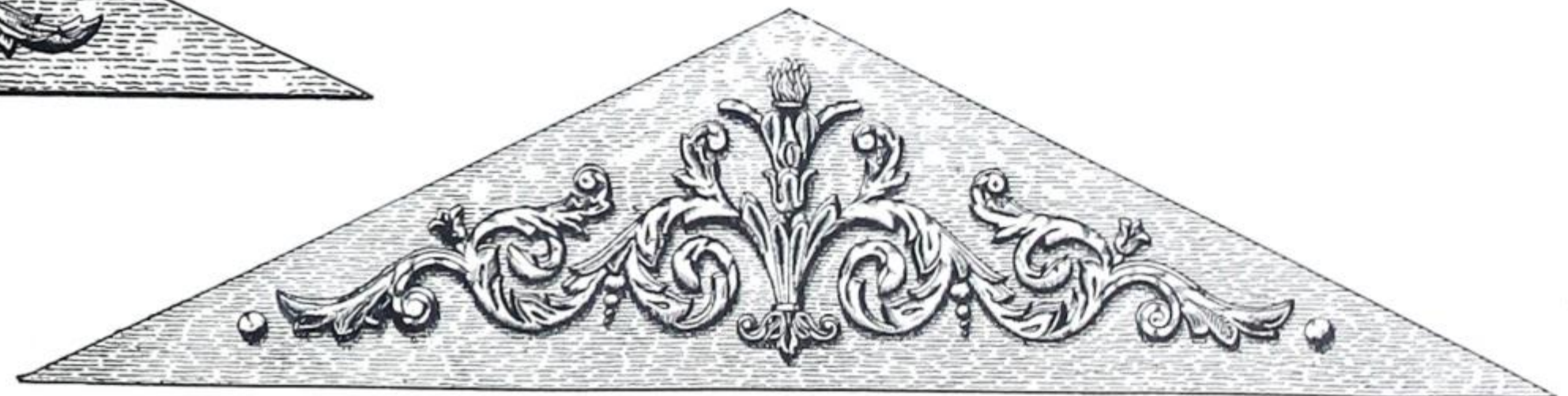

No. 5803.—24 x 96 inches.



No. 5804 —12 x 52 inches.

Sizes given are of the background, which is always sent. Background is made of galvanized steel. Sizes can be varied to suit different spaces. Let us know your requirements.

Rosettes.



No. 5900.
13 inches diameter.



No. 5901.
12 inches diameter.



No. 5902.
12 inches diameter.



No. 5903.
11 1/4 inches diameter.



No. 5904.
10 inches diameter.



No. 5905.
10 inches diameter.



No. 5906.
8 3/4 ins. diameter.



No. 5907.
9 inches diameter.



No. 5908.
7 inches diameter.



No. 5909.
8 x 8 inches.



No. 5910.
8 x 8 inches.



No. 5911.
7 inches diameter.



No. 5914.
8 inches diameter.



No. 5915.
6 1/4 ins. diameter.



No. 5916.
7 ins. diameter.



No. 5912.—28 inches diameter.



No. 5913.—21 inches diameter.



No. 5917.
5 ins. diameter.



No. 5918.
4 1/2 ins. diameter.



No. 5919.
4 1/2 ins. diameter.



No. 5920.
5 ins. diameter.



No. 5921.
4 ins. diameter.



No. 5922.
3 1/2 ins. diam.



No. 5923.
3 1/4 ins. diam.



No. 5924.
3 ins. diam.



No. 5925.
2 3/4 ins. diam.

Ventilating and other Centres shown on pages 164, 165 and 166. New designs are being constantly added.

Balls, Balusters and Twist Tops.

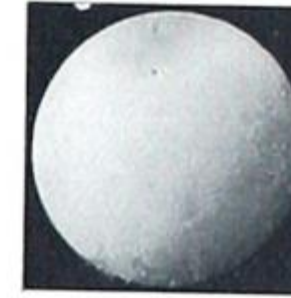
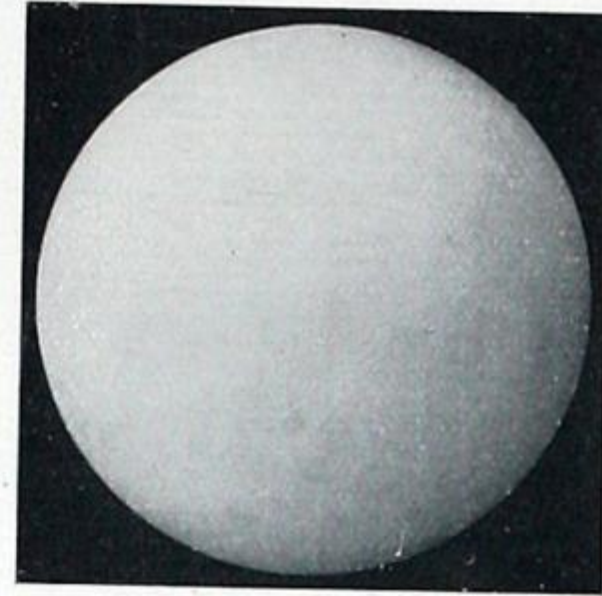
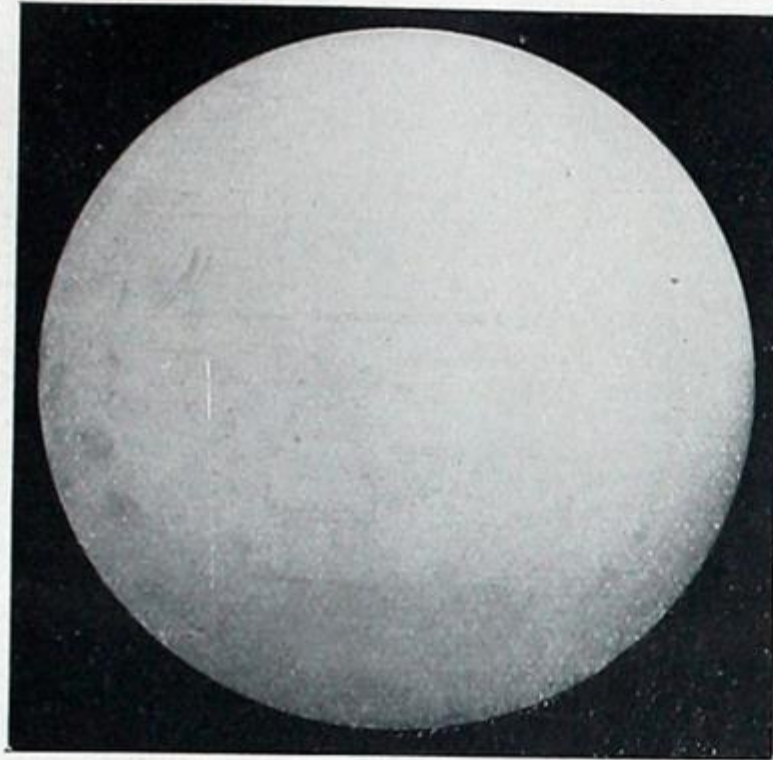

We make the following sizes of balls :

1 inch in diameter		
1 1/2	"	"
2	"	"
3	"	"
4	"	"
5	"	"
6	"	"
8	"	"
10	"	"
12	"	"

The above illustrations show balls, which are pressed from galvanized or leaded iron in half balls. These machine-made balls are much stronger and stiffer than spun zinc balls, and are therefore much preferable for use in architectural work. Balls are shipped in halves, not soldered together.

We supply stamped or spun balusters made to any size or shape.

New designs and sizes are being constantly added. Let us know your requirements.



No. 6151.
7 1/2 inches high.

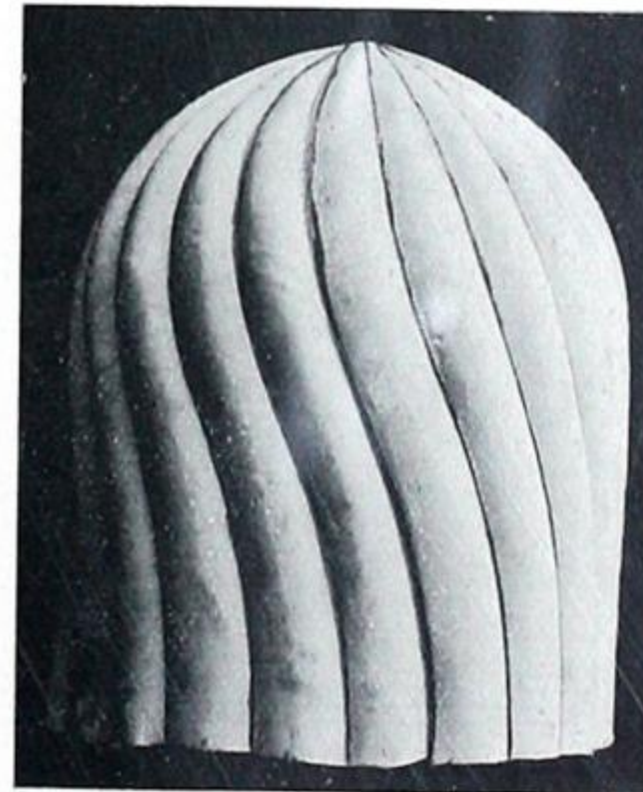

No. 6150.
12 x 12 inches.



No. 6101.
19 inches high.



No. 6100.
24 inches high.

Festoons.

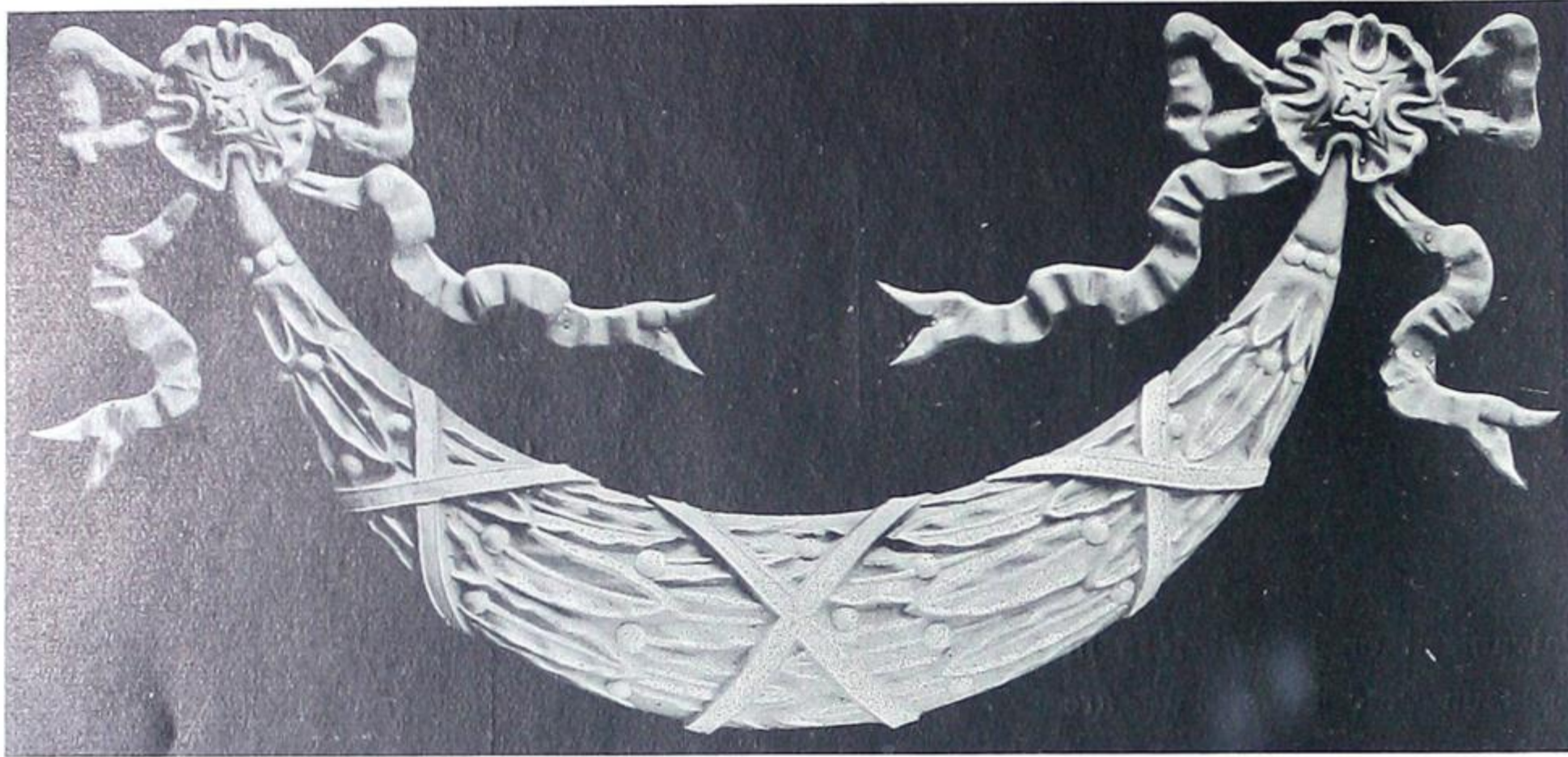

No. 6200.—15 x 37½ inches out to out, 26½ inches on centres.

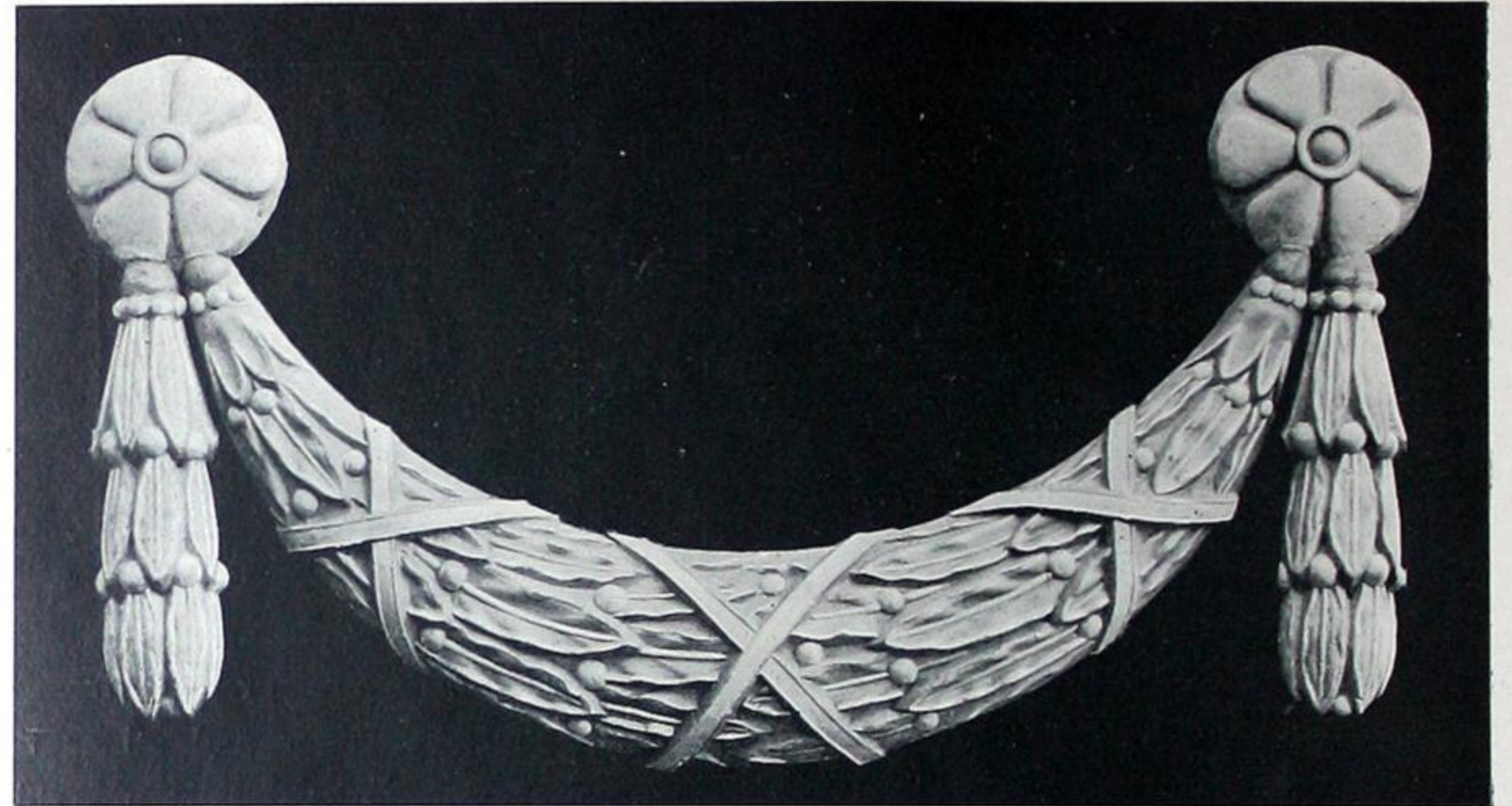

No. 6201.—15 x 32 inches out to out, 26½ inches on centres.

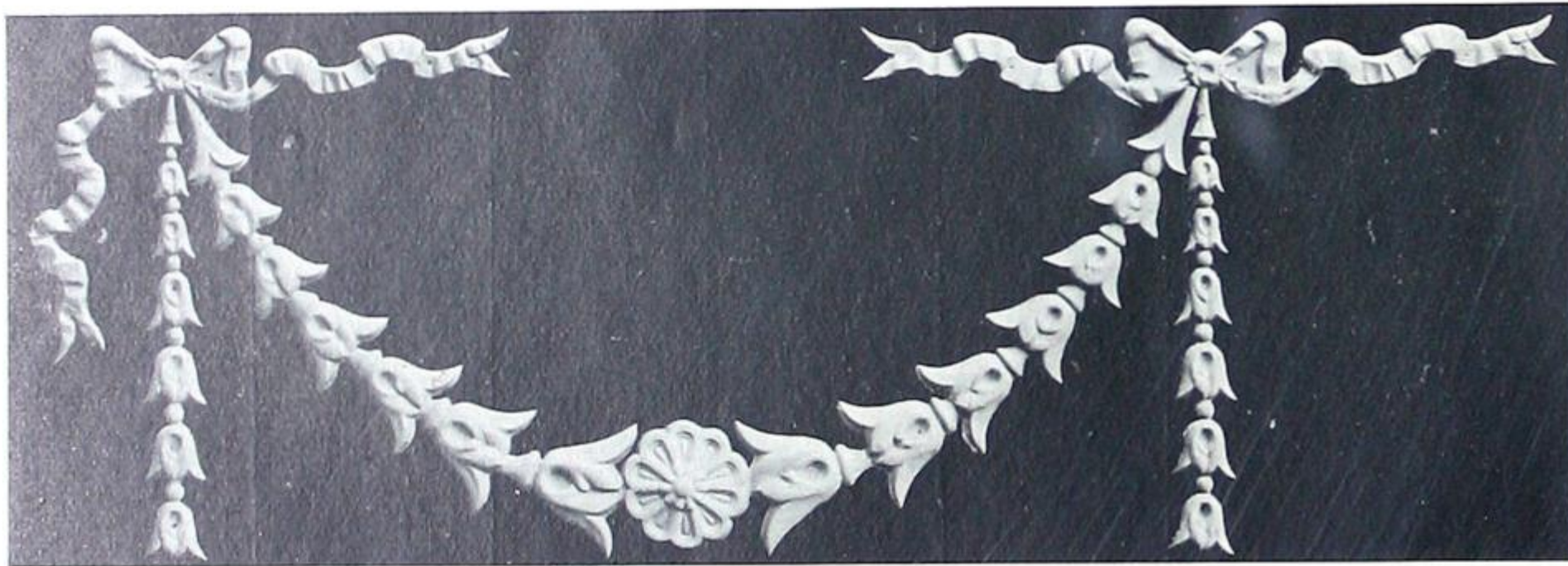

No. 6202.—21 x 60 inches out to out, 40 inches on centres.

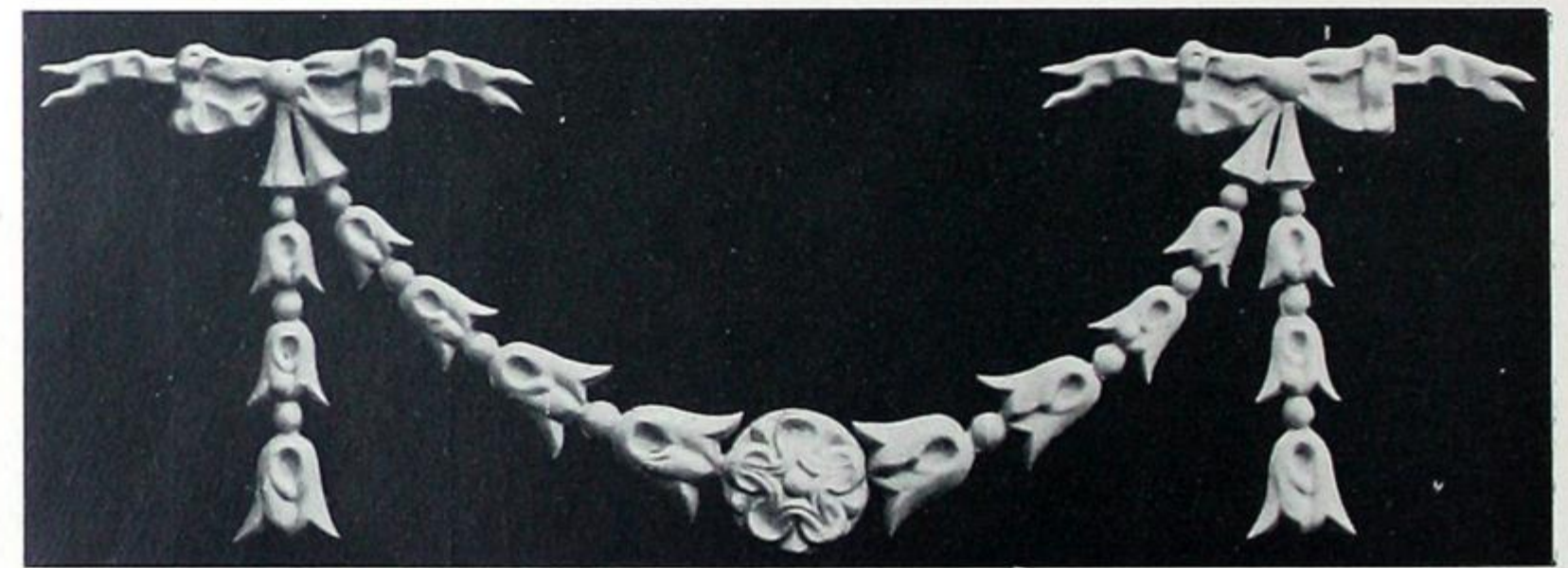

No. 6203.—11 x 30 inches out to out, 21 inches on centres.

New designs are being constantly added. Write us for what you require.

Festoons
and
Wreaths.

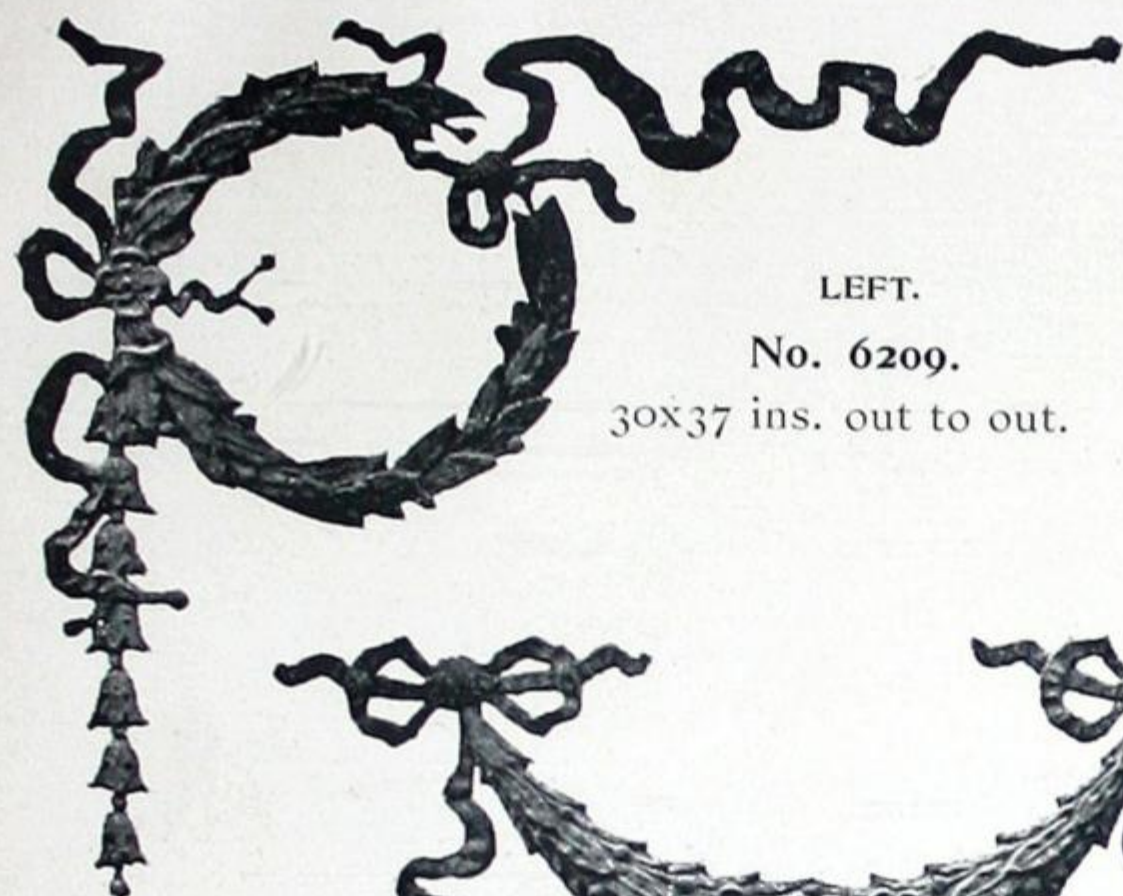

LEFT.
No. 6209.
30x37 ins. out to out.



No. 6208.—13x36 ins. out to out, 23½ ins. on centre.



No. 6205.—10½ inches wide, 19¼ inches on centres.



No. 6204.—12½ inches wide, 27 inches on centres.



No. 6206.—10x28 ins. out to out, 21 ins. on centres.



No. 6207.—10x28 ins. out to out, 24 ins. on centre.

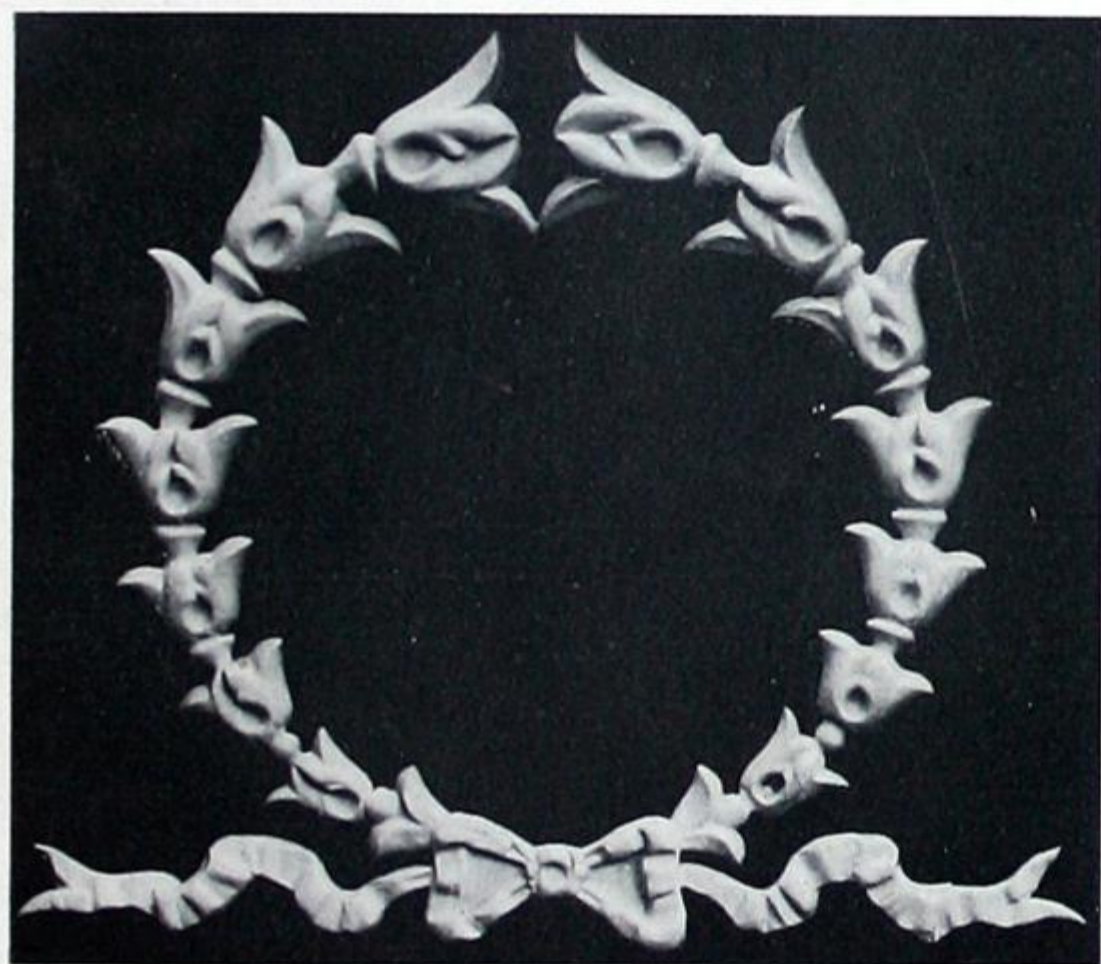

No. 6211.—25½ x 23½ inches.



No. 6210.—17 x 17 inches.



No. 6212.—10½x10½ inches.

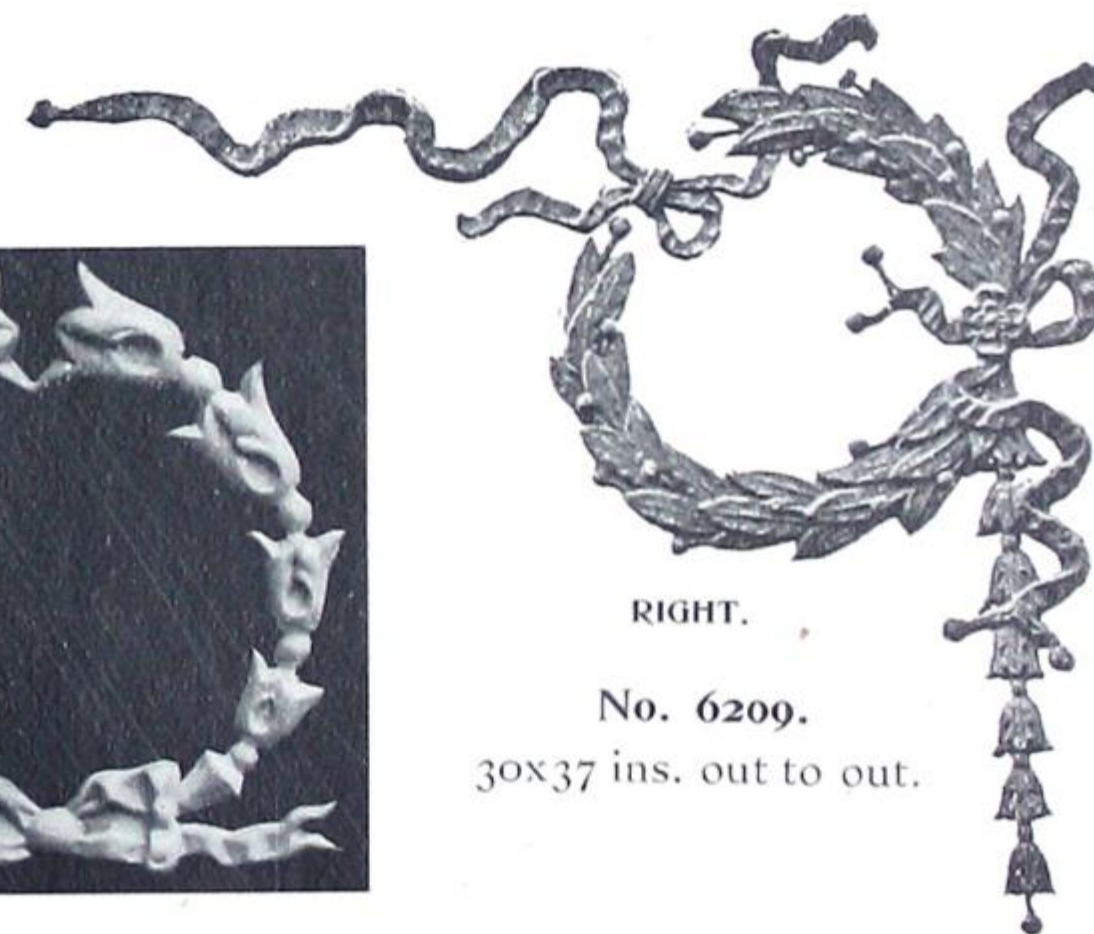

RIGHT.
No. 6209.
30x37 ins. out to out.

Enrichments.



No. 6400.—7 inches wide.



No. 6402.—6 inches wide.



No. 6404.—5 inches wide.



No. 6406.—4 inches wide.



No. 6408.—3 inches wide.



No. 6410.—1½ inches wide.



No. 6401.—6 inches wide.



No. 6403.—5 inches wide.



No. 6405.—4 inches wide.



No. 6407.—3 inches wide.



No. 6409.—2 inches wide.



No. 6411.—3½ inches wide.

Enrichments and Friezes.



No. 6412.—8 inches wide.



No. 6414.—6 inches wide.



No. 6416.—9½ inches wide.



No. 6418.—6½ inches wide.



No. 6420.—5 inches wide.



No. 6421.—3¼ inches wide.



No. 6422.—3 inches wide.



No. 6423.—2½ inches wide.



No. 6424.—2 inches wide.



No. 6425.—1½ inches wide.



No. 6413.—11½ inches wide.



No. 6415.—8 inches wide.



No. 6417.—8¾ inches wide.



No. 6419.—12 inches wide.



No. 6426.—14½ inches wide.

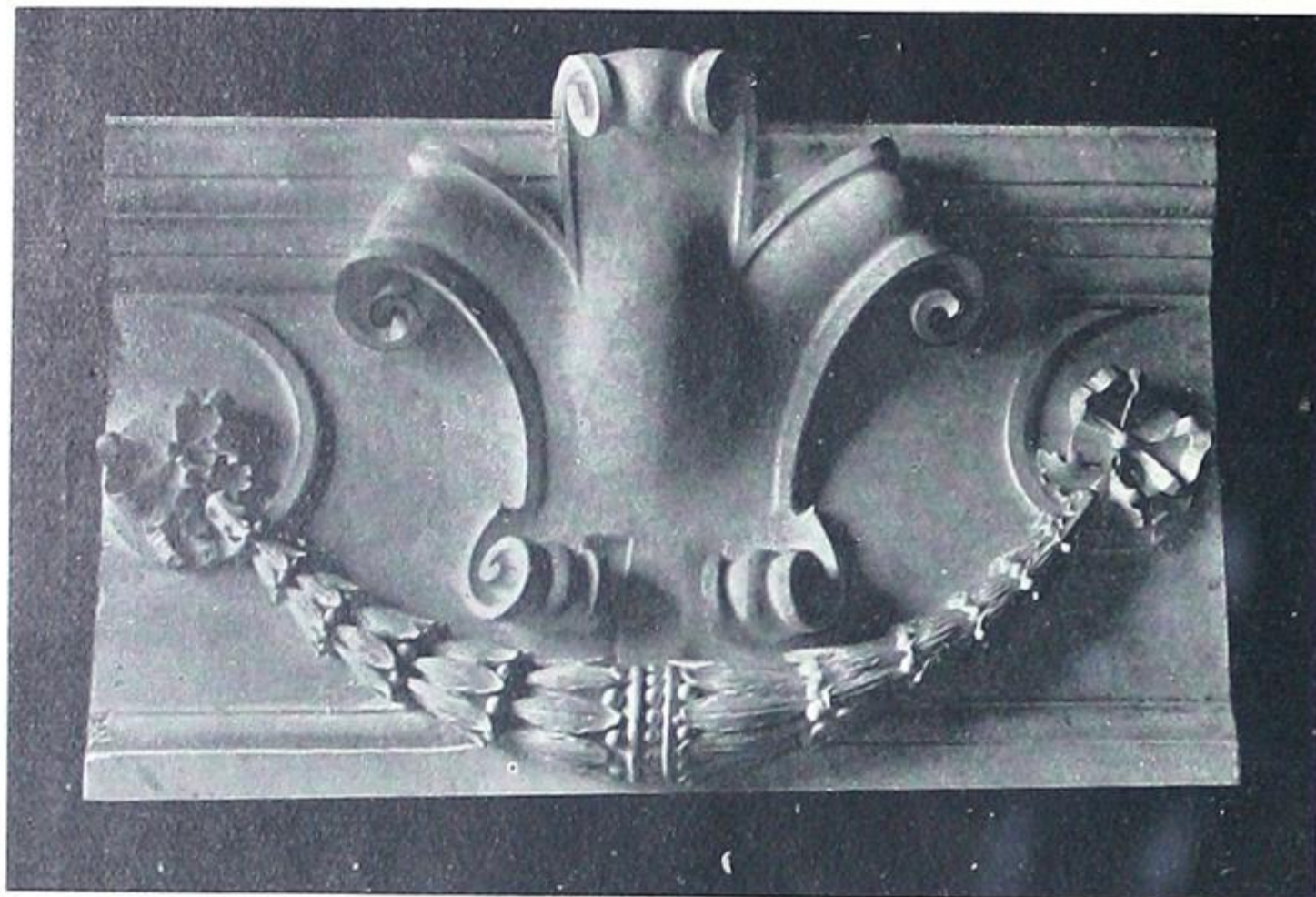

No. 6428.—34 x 51 inches.

Enrichments and Friezes.



No. 6427 —26 inches wide.

New designs are
being added
constantly.

Let us know your
requirements.



No. 6429.—25 inches wide.



No. 6430.—19 inches wide, 98 inches long.

Modillions and Brackets.

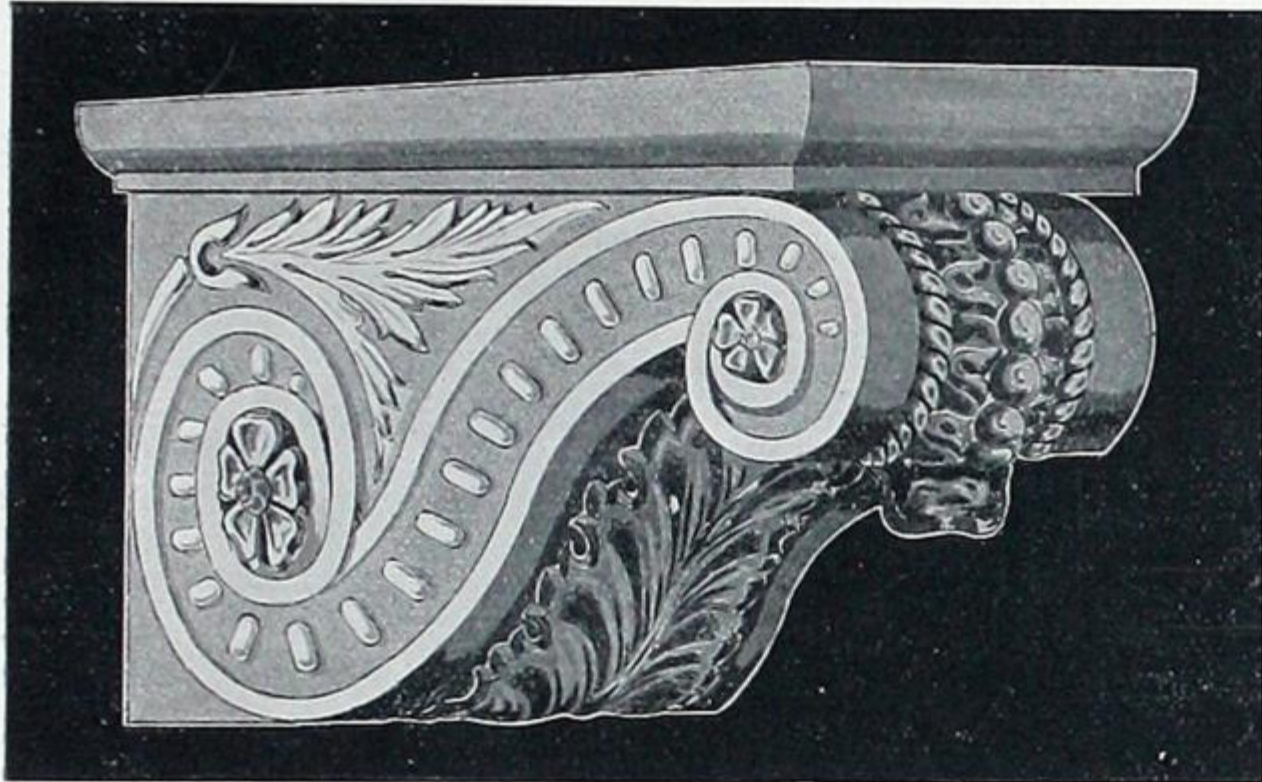

No. 6600.
Projection, 26 ins.; depth, 14 ins.; face width, 7 ins.

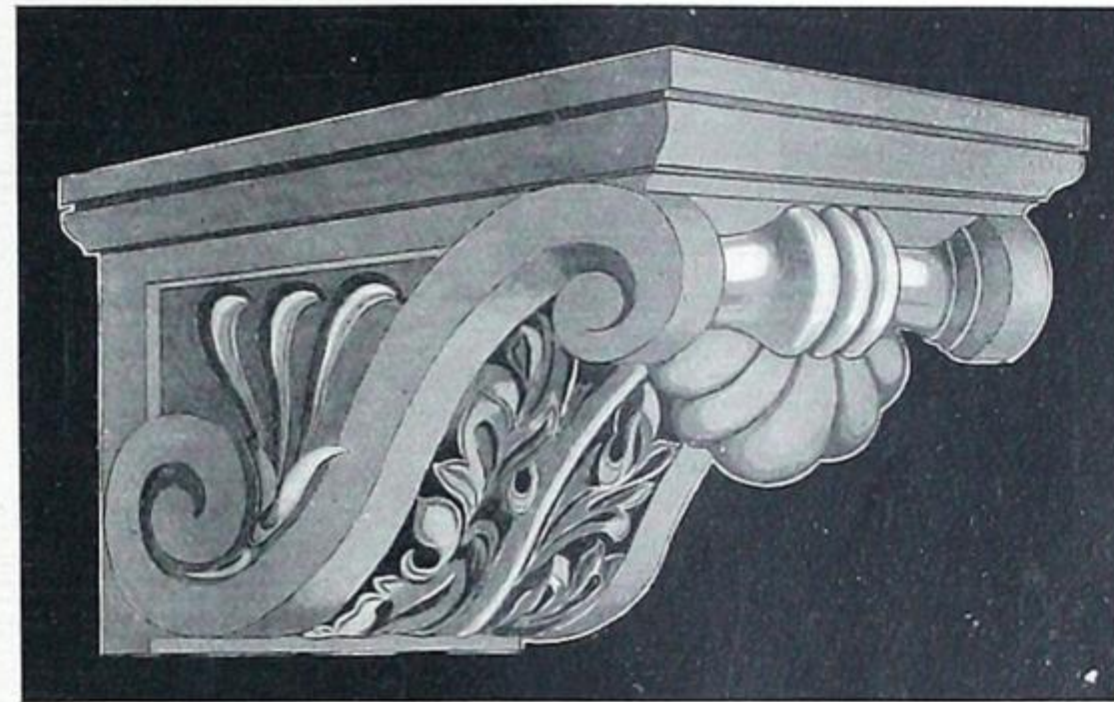

No. 6601.
Projection, 22 ins.; depth, 14 ins.; face width, 12 ins.

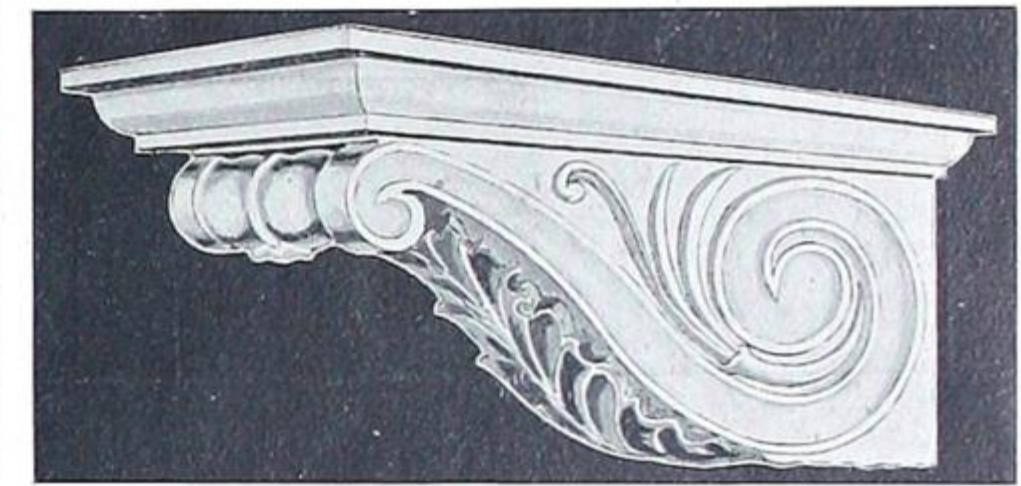

No. 6602.
Projection, 19 inches; depth, 8½ inches;
face width, 7 inches.

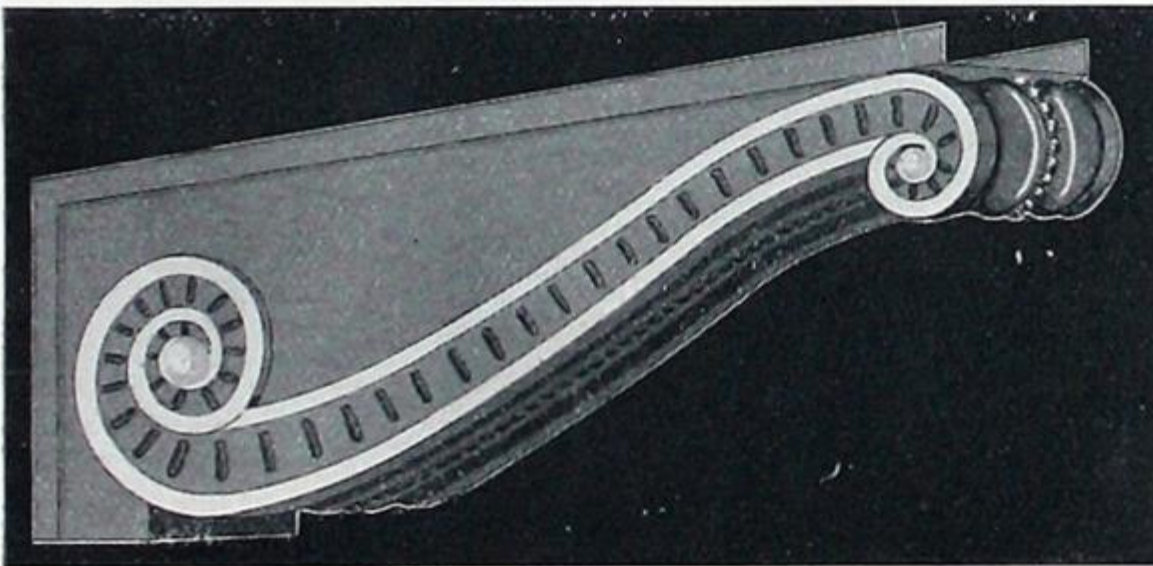

No. 6603.
Projection, 24 inches; depth, 8 inches;
face width, 6 inches.



	Projection.	Depth.	Face.
No. 6604.....	8 ins.....	14 ins.....	5½ ins.
No. 6605.....	6 ins.....	11 ins.....	4½ ins.

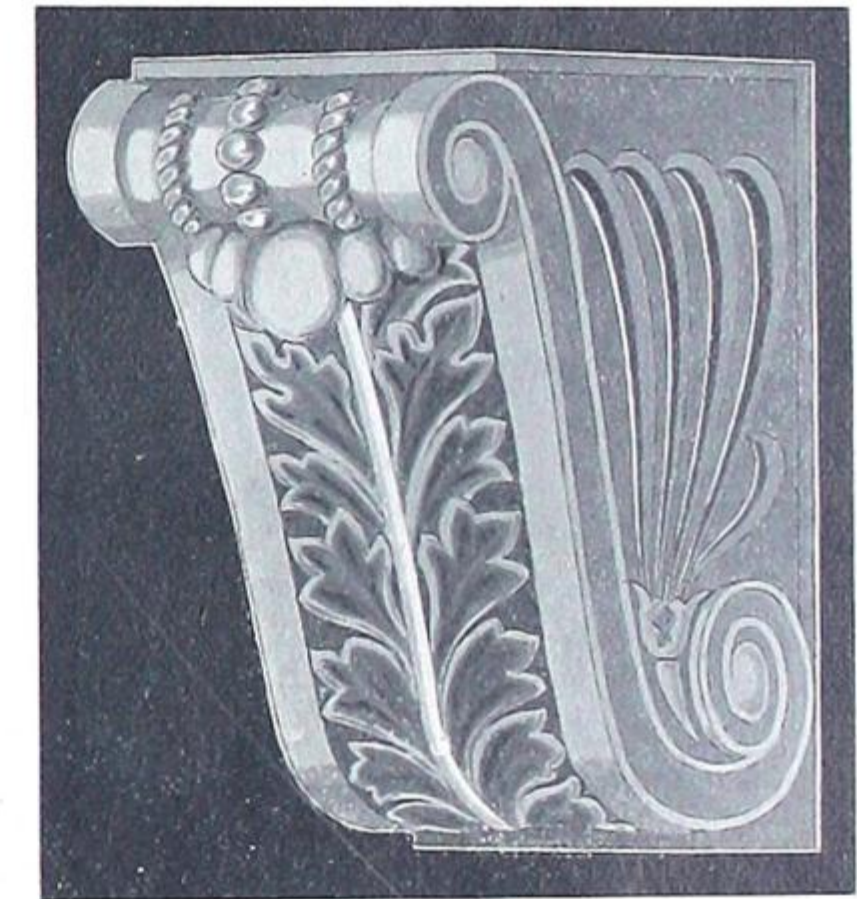

No. 6606.
Projection, 19½ ins.; depth, 19 ins.;
face width, 9 ins.

Modillions, Heads and Brackets.

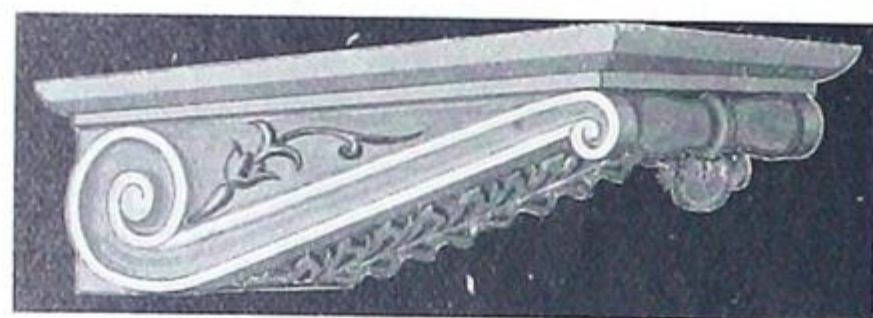

No. 6607.

Projection..... 20 inches.
 Depth..... 5 1/4 "
 Face width..... 5 "



No. 6608.

Projection..... 16 inches.
 Depth..... 7 1/4 "
 Face width..... 7 1/4 "



No. 6609.

Projection..... 11 inches.
 Depth..... 5 "
 Face width..... 5 1/4 "



No. 6610.

Projection.. 4 1/2 ins.
 Depth..... 3 "
 Face width.. 4 "



No. 6800.

21 x 22 inches.



No. 6801.

8 1/2 x 9 inches.



No. 6802.

18 x 18 inches.



No. 6611.

Projection..... 9 3/4 inches.
 Height..... 23 1/2 "

New designs are being constantly added. Let us know your requirements.

Capitals.



No. 7000.

Height..... 24 inches.
 Abacus (across)..... 34 "
 Face of pilaster 19 "



No. 7001.

Height..... 23 inches.
 Abacus (across) 30 "
 Face of pilaster 17½ "



No. 7002.

Height..... 28 inches.
 Abacus (across) 29 "
 Face of pilaster 18 "

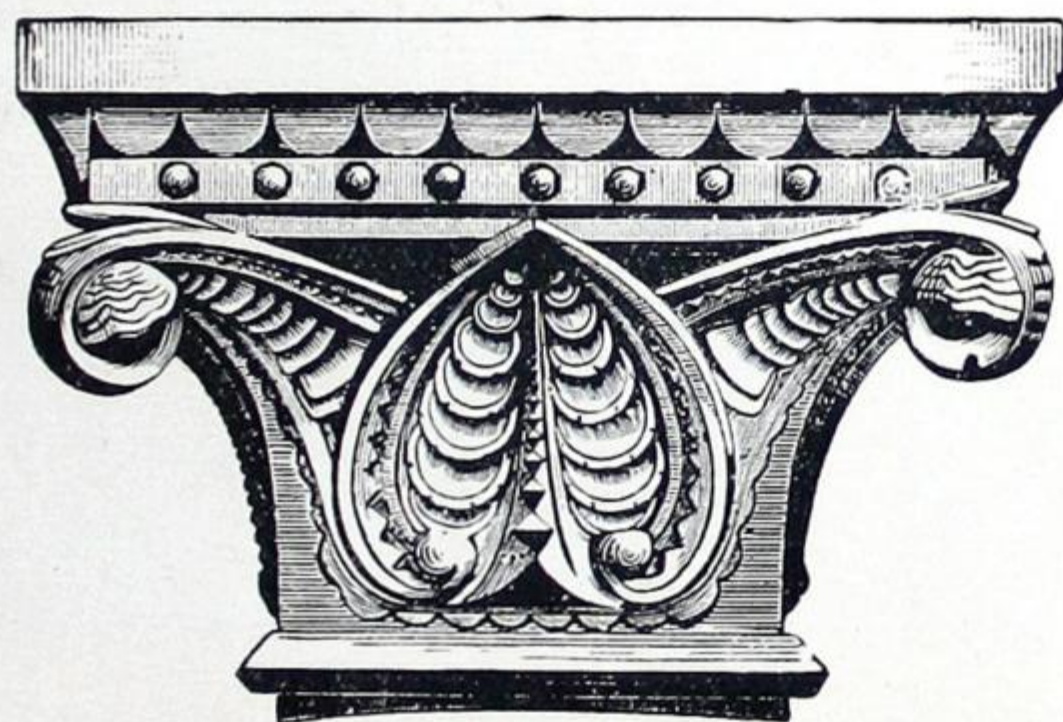

No. 7003.

Height..... 19 inches.
 Abacus (across) 29 "
 Face of pilaster 15 "



No. 7004.

Height..... 24 inches.
 Abacus (across) 28½ "
 Diameter at neck..... 16½ "

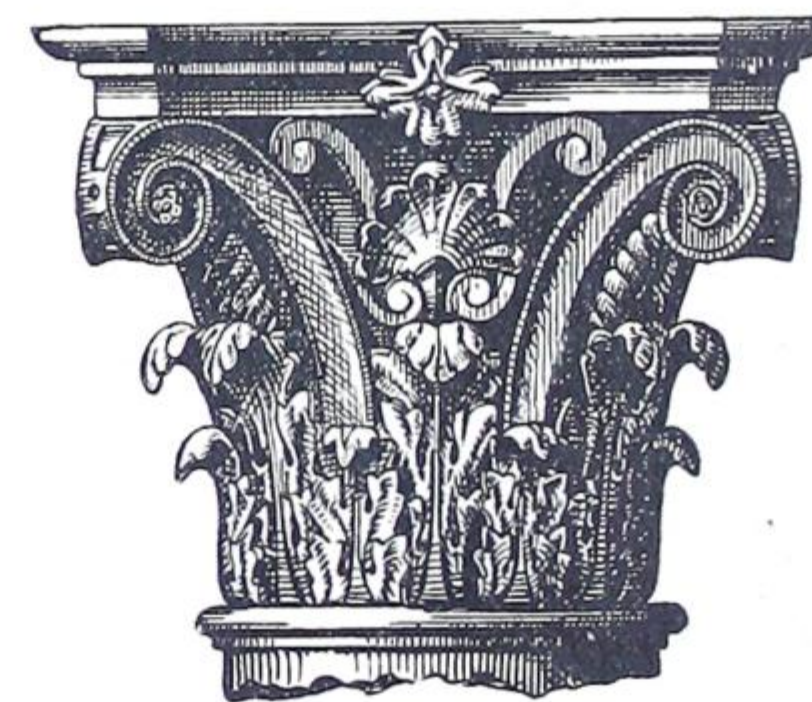

No. 7005.

Height 21 inches.
 Abacus (across) 27 "
 Diameter at neck..... 15 "

Capitals.



No. 7006.
Height..... 17 1/2 ins.
Abacus (across)... 21 "
Diameter at neck... 11 "



No. 7007.
Height..... 16 1/2 ins.
Abacus (across)... 15 "
Diameter at neck.. 7 1/2 "



No. 7008.
Height..... 15 ins.
Abacus (across)... 25 "
Face of pilaster..... 14 "



No.	Height.	Abacus.	Neck.
7009	12 1/2 ins.	15 ins.	8 ins.
7010	12 "	12 "	7 "
7011	10 "	10 "	6 "



No. 7012.
Height..... 14 ins.
Abacus (across)... 20 "
Face of pilaster.... 11 1/2 "



No. 7013.
Height..... 9 1/2 ins.
Abacus (across)... 13 1/2 "
Diameter at neck... 8 1/2 "



No. 7014.
Height..... 3 ins.
Abacus (across)... 7 1/2 "
Diameter at neck.... 5 3/4 "



No. 7015.
Height..... 10 1/2 ins.
Abacus (across)... 10 "
Face of pilaster... 8 "



No. 7016.
Height..... 12 ins.
Abacus (across)... 14 "
Diameter at neck.... 10 "



No. 7017.
Height..... 10 ins.
Abacus (across)... 11 "
Diameter at neck... 5 1/2 "



No. 7018.
Height..... 9 ins.
Abacus (across)... 13 "
Diameter at neck.... 5 "

Capitals.



No. 7019.

Height..... 24 inches.
 Abacus (across) 36 "
 Diameter at neck 19½ "

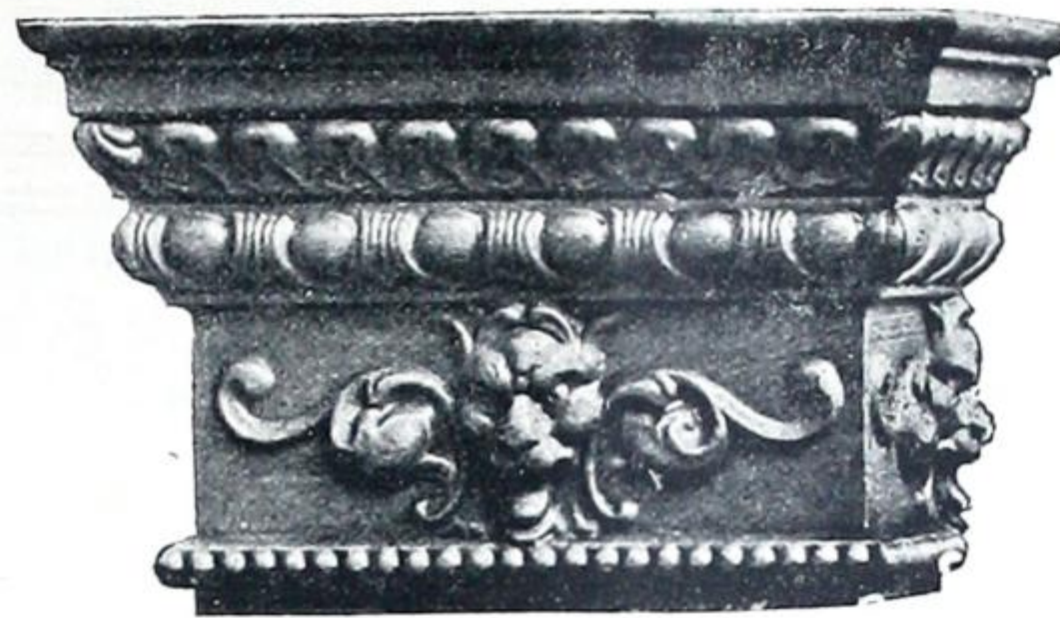

No. 7020.

Height..... 10½ inches.
 Abacus (across) 17 "
 Face of pilaster 12 "



No. 7021.

Height..... 15 inches.
 Abacus (across)..... 23 "
 Face of pilaster 14 "

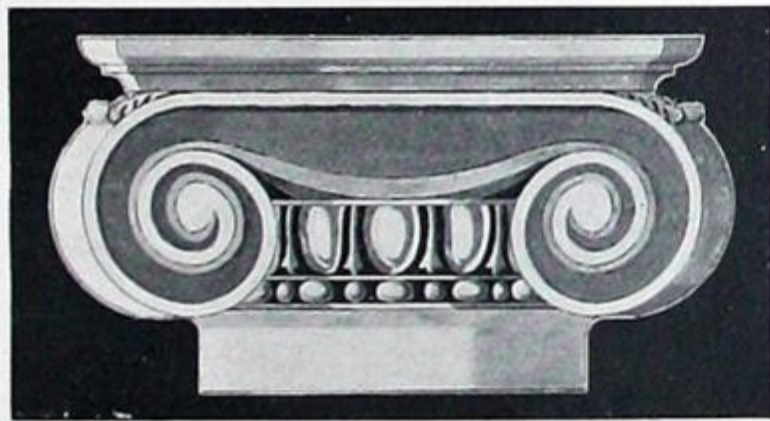

No. 7022.

Height..... 8 ins.
 Abacus (across)..... 18 "
 Diameter at neck..... 10 "



No. 7023.

Height..... 10½ ins.
 Abacus (across). 13 "
 Diameter at neck 5 "



No. 7024.

Height..... 10 ins.
 Abacus (across).. 14 "
 Diameter at neck. 8½ "

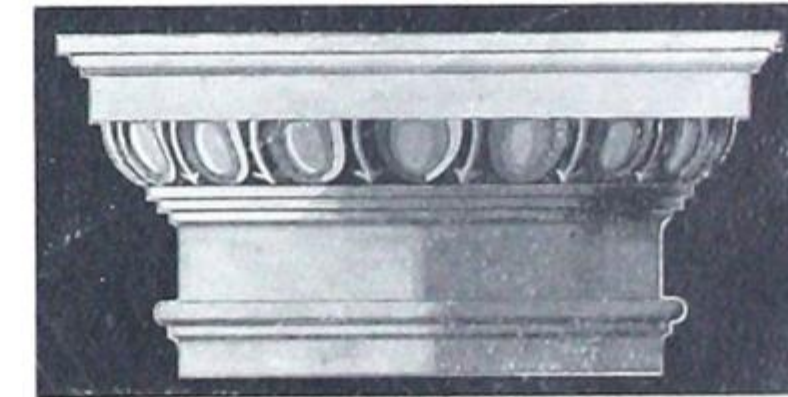

No. 7025.

Height..... 6¾ ins.
 Abacus (across).... 14 "
 Diameter at neck.... 10 "

©atalogue "S"

THE
METALLIC ROOFING CO
OF CANADA (LIMITED)

(INCORPORATED UNDER DOMINION CHARTER 1895)

MANUFACTURERS OF

Architectural Sheet Metal Building Material

OF EVERY DESCRIPTION.



HEAD OFFICE AND WORKS:

COR. KING AND DUFFERIN STREETS,

TORONTO, CANADA.

CABLE ADDRESS:
"METALLIC" TORONTO.

CODES:
A. B. C. (4th EDITION) and LIEBER'S.

Entered according to Act of the Parliament of Canada, in the year 1900, by The Metallic Roofing Company of Canada, Limited, in the Department of Agriculture.

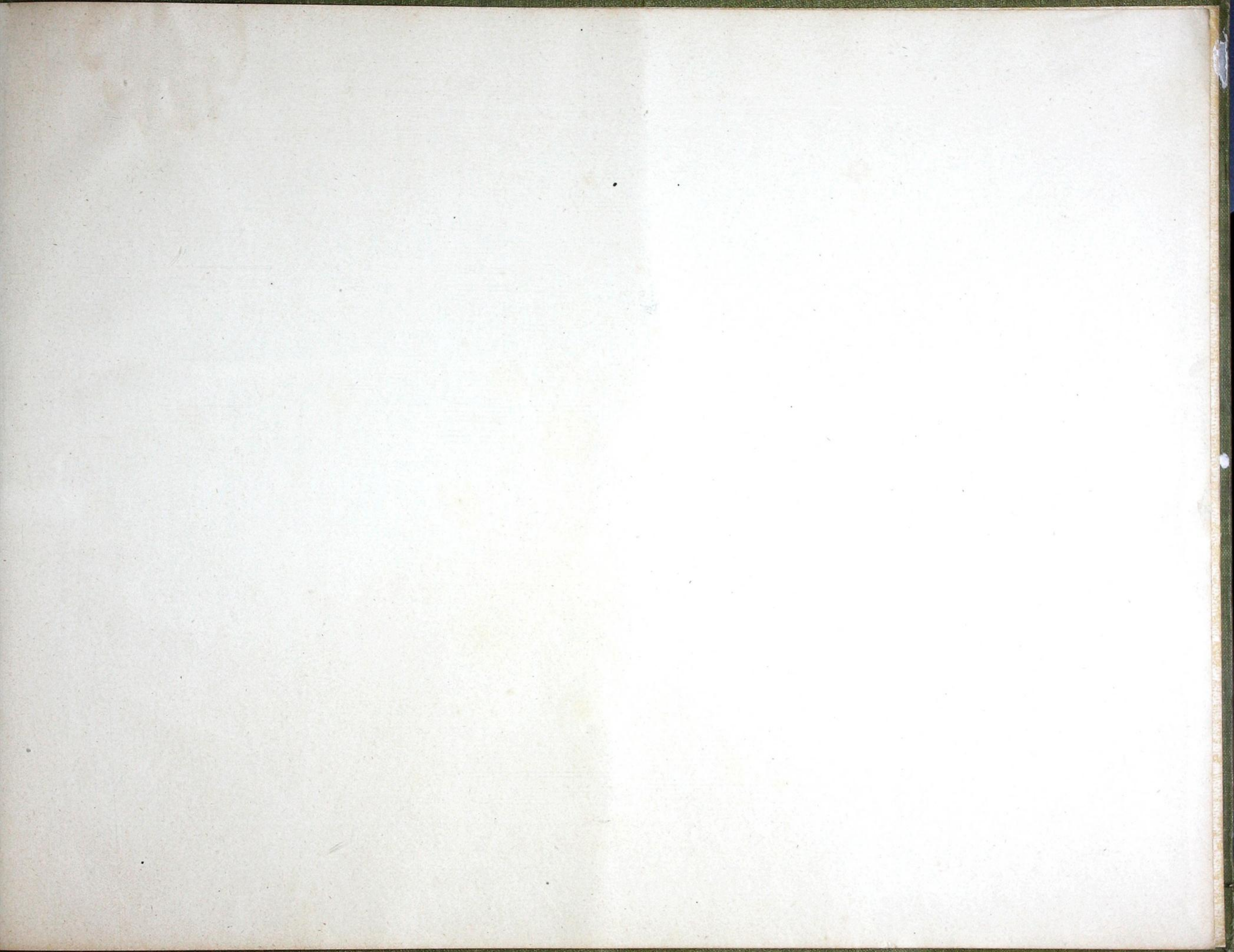



HNL 1/2001

352 pp
collated
complete
copy

1/2001

#10984



Digitized by:



ASSOCIATION FOR
PRESERVATION TECHNOLOGY,
INTERNATIONAL

BUILDING
TECHNOLOGY
HERITAGE
LIBRARY

www.apti.org

From the collection of:

CCA

CANADIAN CENTRE FOR ARCHITECTURE /
CENTRE CANADIEN D'ARCHITECTURE

www.cca.qc.ca

